

CATALOGO APPLICAZIONI BATTERIE PER VEICOLI COMMERCIALI
COMMERCIAL VEHICLES BATTERIES APPLICATION CATALOGUE
CATALOGUE APPLICATIONS BATTERIES POUR VÉHICULES UTILITAIRES
ANWENDUNGSKATALOG DER BATTERIEN FÜR NUTZFAHRZEUGE
CATÁLOGO DE APLICACIONES BATERÍAS PARA VEHÍCULO COMERCIAL
МОДЕЛЬНЫЙ РЯД ТИПОВ АККУМУЛЯТОРНЫХ
БАТАРЕЙ ДЛЯ ГРУЗОВИКОВ И ТРАКТОРОВ

2016

FIAMM

Mobility
Power Solutions

La tecnologia del nuovo coperchio piano con labirinto interno
The technology of the new flat lid with internal labyrinth
La technologie du nouveau couvercle plat avec labyrinthe interne
Die neue Labyrinth-Flachdeckel-Technologie
La tecnología de la nueva tapa plana con laberinto interior
Новая технология для плоской крышки с внутренними перемычками

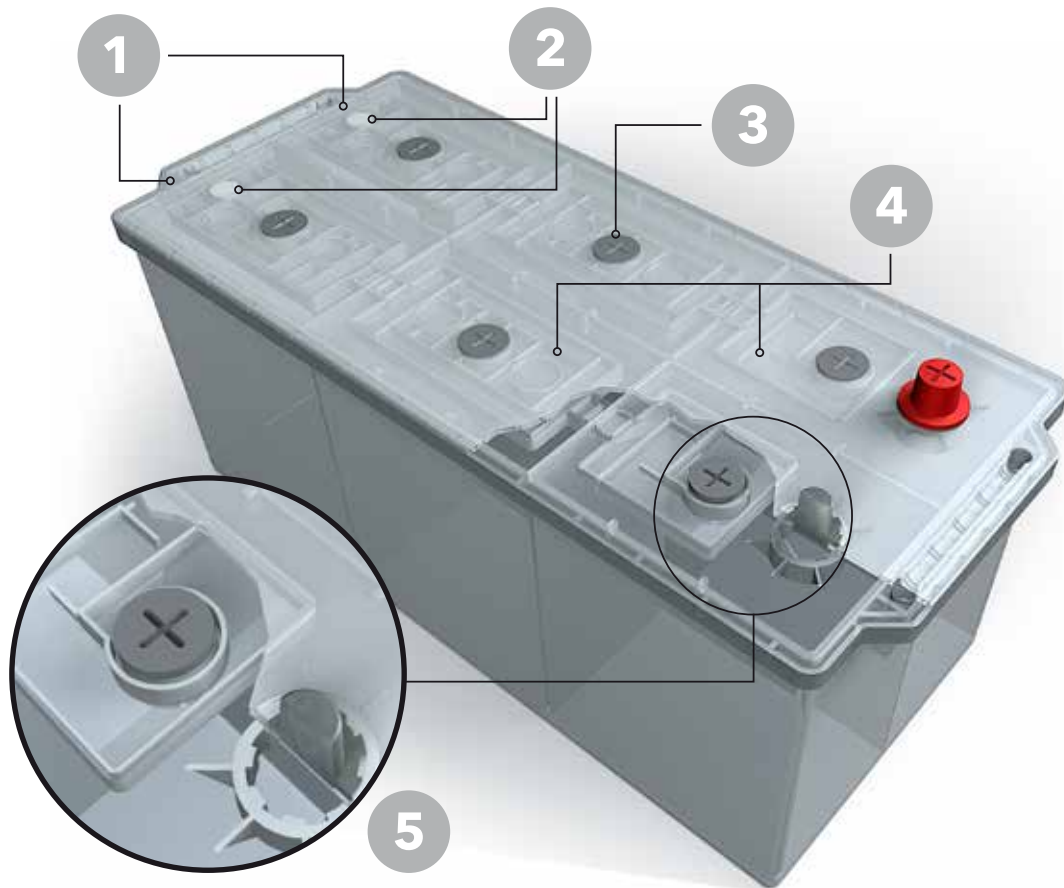

1 DEGASAGGIO CENTRALIZZATO / **2** DOPPIO FLAME ARRESTOR / **3** TAPPI A SCOMPARSA / **4** CAMERE DI RITENUTA ELETTROLITA / **5** PARTICOLARE DELLA CAMERA DI RITENUTA

1 CENTRALISED DEGASSING / **2** DUAL FLAME ARRESTOR / **3** CONCEALED CAPS / **4** ELECTROLYTE STORAGE CHAMBERS / **5** DETAIL OF THE STORAGE CHAMBER

1 DÉGAZAGE CENTRALISÉ / **2** DOUBLE PARE-FLAMMES / **3** BOUCHONS ESCAMOTABLES / **4** CHAMBRES DE RETENUE D'ÉLECTROLYTE / **5** DÉTAIL DE LA CHAMBRE DE RETENUE

1 ZENTRALENTGASUNG / **2** DOPPELTER RÜCKZÜNDSCHUTZ / **3** EINDREHBARE STOPFEN / **4** ELEKTROLYTBEHÄLTER / **5** DETAIL DES FASSUNGSBEHÄLTERS

1 DESGASIFICACIÓN CENTRALIZADA / **2** DOBLE FLAME ARRESTOR / **3** TAPONES ESCAMOTEABLES / **4** CÁMARAS DE RETENCIÓN ELECTROLITO / **5** DETALLE DE LA CÁMARA DE ESTANQUEIDAD

1 DESGASIFICACIÓN CENTRALIZADA / **2** DOBLE FLAME ARRESTOR / **3** TAPONES ESCAMOTEABLES / **4** CÁMARAS DE RETENCIÓN ELECTROLITO / **5** DETALLE DE LA CÁMARA DE ESTANQUEIDAD

1 ЦЕНТРАЛИЗОВАННЫЙ ГАЗОТВОД / **2** ДВОЙНОЙ ПЛАМЕГАСИТЕЛЬ / **3** УТАПЛИВАЕМЫЕ ПРОБКИ / **4** КАМЕРА УДЕРЖИВАНИЯ ЭЛЕКТРОЛИТА / **5** ДЕТАЛЬ КАМЕРЫ УДЕРЖИВАНИЯ

<p><i>LA NOSTRA GAMMA</i> OUR RANGE NOTRE GAMME UNSER SORTIMENT NUESTRA GAMA ГАММА НАШЕЙ ПРОДУКЦИИ</p>	<p>4</p>
<p><i>GAMMA E CARATTERISTICHE DELLE BATTERIE</i> OVERVIEW OF THE RANGE WITH TECHNICAL DATA PROGRAMME DES BATTERIES AVEC CARACTÉRISTIQUES TECHNIQUES TYPENLISTE MIT TECHNISCHEM DATEN PROGRAMA DE BATERÍAS CON SUS CARACTERÍSTICAS TÉCNICAS СЕРИИ И ХАРАКТЕРИСТИКИ АККУМУЛЯТОРОВ</p>	<p>9</p>
<p><i>POLARITÀ, TIPO POLO, FISSAGGI ALLA BASE</i> LAYOUT, TERMINAL AND HOLD DOWN SCHÉMA, BORNE ET FIXATION SCHALTUNG, POLTYP UND BODENLEISTEN ESQUEMA, POLO Y TIPO DE ENVASE СХЕМА, КЛЕММА И ЗАЖИМ</p>	<p>14</p>
<p><i>TABELLA COMPARATIVA</i> CROSS REFERENCE LIST TABLEAU D'ÉQUIVALENCES UMSCHLÜSSELUNGSLISTE TABLA DE CRUCE DE REFERENCIAS ТАБЛИЦА СРАВНЕНИЯ</p>	<p>15</p>
<p><i>TABELLE APPLICAZIONI</i> APPLICATION LIST LISTE D'APPLICATIONS ZUORDNUNGSLISTE APLICACIONES ТАБЛИЦА СООТВЕТСТВИЯ ТИПОВ АККУМУЛЯТОРНЫХ БАТАРЕЙ</p>	<p>17</p>
<p><i>LE PRESTAZIONI DELLA NUOVA GAMMA TRUCK</i> PERFORMANCE OF THE NEW TRUCK RANGE LES PERFORMANCES DE LA NOUVELLE GAMME CAMIONS DIE LEISTUNGSWERTE DES NEUEN LKW-SORTIMENTS LAS PRESTACIONES DE LA NUEVA GAMA TRUCK ХАРАКТЕРИСТИКИ НОВОЙ ГАММЫ ИЗДЕЛИЙ ДЛЯ ГРУЗОВЫХ АВТОМОБИЛЕЙ</p>	<p>279</p>

POWERCUBE APC



- > Batteria ad acido libero a ridotta manutenzione, non richiede rabbocchi ma i tappi lo consentono se necessario
- > Coperchio piano (**FLAT**) con labirinto interno, camere di ricondensazione dei gas, tappi con speciale anello di tenuta (**OR**) anti perdite, degasaggio centralizzato a doppio canale e con doppia pastiglia antifiamma
- > Innovativo doppio sistema di bloccaggio delle piastre all'interno della cella per una elevata resistenza alle vibrazioni e conforme ai più elevati standard del settore automotive
- > Elevata potenza di avviamento
- > Ottima accettazione di carica
- > Elevata durata ai cicli di carica/scarica
- > Buona resistenza alle scariche profonde
- > Eccellente resistenza alle vibrazioni

- > Low-maintenance free acid battery requiring no top-ups, but the caps will allow it to be topped up if necessary
- > Flat lid with internal labyrinth, gas recondensation chambers, caps with special O-ring preventing leaks, dual-channel centralised degassing with dual flame arrestor pad
- > Innovative dual plate blocking system inside the cell that provides high resistance to vibrations and that complies with the highest automotive industry standards
- > High starting power
- > Excellent charge acceptance
- > High endurance to charge/discharge cycles
- > Good resistance to intense discharges
- > Excellent vibration resistance

- > Batterie à acide libre à entretien réduit, ne nécessite aucun appoint mais les bouchons le permettent si nécessaire
- > Couvercle plat (**PLAT**) avec labyrinthe interne, chambres de recondensation des gaz, bouchons avec anneau d'étanchéité spécial (**joint torique**) anti-fuites, dégazage centralisé à double canal et avec double pastille pare-flamme
- > Double système de blocage des plaques à l'intérieur de la cellule innovant pour une résistance élevée aux vibrations et conforme aux normes les plus strictes du secteur automobile
- > Puissance de démarrage élevée
- > Excellente acceptation de charge
- > Durée élevée aux cycles de charge/décharge
- > Bonne résistance aux décharges profondes
- > Excellente résistance aux vibrations

- > Wartungsarme Batterie mit freier Säure, kein Nachfüllen nötig, dennoch über die Stopfen möglich
- > Flacher (**FLACH**) Labyrinthdeckel, Gas-Rekondensationsbehälter, Stopfen mit speziellem Dichtring (**OR**) gegen Austritte, doppelte Zentralentgasung und doppelter Rückzündschutz
- > Innovatives zweifaches Platten-Befestigungssystem an der Zelleninnenseite für eine erhöhte Rüttelfestigkeit entsprechend der strengsten Vorschriften im Automobilsektor
- > Erhöhte Startleistung
- > Hervorragende Ladeakzeptanz
- > Erhöhte Zyklenfestigkeit
- > Gute Entladungsfestigkeit
- > Exzellente Rüttelfestigkeit

- > Batería de ácido libre de mantenimiento reducido, no necesita repostado, pero los tapones lo permiten si es necesario
- > Tapa plana (**PLANA**) con laberinto interno, cámaras de nueva condensación de los gases, tapas con junta de estanqueidad especial (**OR**) antifugas, desgasificación centralizada con doble canal y doble pastilla antiincendios
- > Innovador doble sistema de bloqueo de las placas en el interior de la célula para una elevada resistencia a las vibraciones y conforme a los estándares más elevados del sector de la automoción
- > Elevada potencia de arranque
- > Óptima aceptación de carga
- > Elevada duración ante los ciclos de carga/descarga
- > Buena resistencia a las descargas profundas
- > Excelente resistencia a las vibraciones

- > Традиционные малообслуживаемые аккумуляторные батареи; доливка не требуется, но при необходимости возможна (пробки позволяют это сделать)
- > Плоская крышка (**FLAT**) с внутренними перемычками, камерами рекомбинации газов, пробками со специальным уплотнительным кольцом (**OR**) для предотвращения утечек, системой централизованного газоотвода через двойной канал и двойной пластиной пламегасителя
- > Новаторская двойная система крепления пластин внутри ячейки, обеспечивающая повышенную вибростойкость и соответствующая самым жестким стандартам в автомобильной отрасли
- > Повышенная пусковая мощность
- > Очень высокий КПД запасаемого заряда (емкость)
- > Повышенное количество циклов разряда-заряда
- > Хорошие показатели стойкости к глубокому разряду
- > Превосходная вибростойкость

POWERCUBE EHD



- > Batteria ad acido libero a ridotta manutenzione, non richiede rabbocchi ma i tappi lo consentono se necessario
- > Coperchio piano (**FLAT**) con labirinto interno, camere di ricondensazione dei gas, tappi con speciale anello di tenuta (**OR**) anti perdite, degasaggio centralizzato a doppio canale e con doppia pastiglia antifiamma (solo per formati dimensionali A-B-C)
- > Innovativo doppio sistema di bloccaggio delle piastre all'interno della cella per una elevata resistenza alle vibrazioni e conforme ai più elevati standard del settore automotive
- > Grande potenza di avviamento
- > Buona accettazione di carica
- > Buona durata ai cicli di carica/scarica
- > Buona resistenza alle vibrazioni

- > Low-maintenance free acid battery requiring no top-ups, but the caps will allow it to be topped up if necessary
- > Flat lid with internal labyrinth, gas recondensation chambers, caps with special O-ring preventing leaks, dual-channel centralised degassing with dual flame arrestor pad (only for A-B-C Batteries)
- > Innovative dual plate blocking system inside the cell that provides high resistance to vibrations and that complies with the highest automotive industry standards
- > Great starting power
- > Good charge acceptance
- > Good endurance to charge/discharge cycles
- > Good vibration resistance

- > Batterie à acide libre à entretien réduit, ne nécessite aucun appoint mais les bouchons le permettent si nécessaire
- > Couvercle plat (**PLAT**) avec labyrinthe interne, chambres de recondensation des gaz, bouchons avec anneau d'étanchéité spécial (**joint torique**) anti-fuites, dégazage centralisé à double canal et avec double pastille pare-flamme (seulement pour les groupes dimensionnels A-B-C)
- > Double système de blocage des plaques à l'intérieur de la cellule innovant pour une résistance élevée aux vibrations et conforme aux normes les plus strictes du secteur automobile
- > Forte puissance de démarrage
- > Bonne acceptation de charge
- > Bonne durée aux cycles de charge/décharge
- > Bonne résistance aux vibrations

- > Wartungsarme Batterie mit freier Säure, kein Nachfüllen nötig, dennoch über die Stopfen möglich
- > Flacher (**FLACH**) Labyrinthdeckel, Gas-Rekondensationsbehälter, Stopfen mit speziellem Dichtring (**OR**) gegen Austritte, doppelte Zentralentgasung und doppelter Rückzündschutz (nur für A-B-C Batterietypen)
- > Innovatives zweifaches Platten-Befestigungssystem an der Zelleninnenseite für eine erhöhte Rüttelfestigkeit entsprechend der strengsten Vorschriften im Automobilsektor
- > Große Startleistung
- > Gute Ladeakzeptanz
- > Gute Zyklenfestigkeit
- > Gute Rüttelfestigkeit

- > Batería de ácido libre de mantenimiento reducido, no necesita repostado, pero los tapones lo permiten si es necesario
- > Tapa plana (**PLANA**) con laberinto interno, cámaras de nueva condensación de los gases, tapas con junta de estanqueidad especial (**OR**) antifugas, desgasificación centralizada con doble canal y doble pastilla antiincendios (solo para dimensiones A-B-C)
- > Innovador doble sistema de bloqueo de las placas en el interior de la célula para una elevada resistencia a las vibraciones y conforme a los estándares más elevados del sector de la automoción
- > Gran potencia de arranque
- > Buena aceptación de carga
- > Buena duración ante los ciclos de carga/descarga
- > Buena resistencia a las vibraciones

- > Традиционные малообслуживаемые аккумуляторные батареи; доливка не требуется, но возможна при необходимости (пробки позволяют это сделать)
- > Плоская крышка (**FLAT**) с внутренними переключками, камерами рекомбинации газов, пробками со специальным уплотнительным кольцом (**OR**) для предотвращения утечек, системой централизованного газоотвода через двойной канал и двойной пластиной пламегасителя (только для батарей A-B-C)
- > Новаторская двойная система крепления пластин внутри ячейки, обеспечивающая повышенную вибростойкость и соответствующая самым жестким стандартам в автомобильной отрасли
- > Очень высокая пусковая мощность
- > Хороший уровень КПД запаасаемого заряда (емкость)
- > Хороший показатель количества циклов разряда-заряда
- > Хороший уровень вибростойкости

POWERCUBE AGM



- > Batteria VRLA AGM a ricombinazione di gas
- > Assolutamente esente da manutenzione
- > Coperchio **“Sealed”**
- > Maggiore potenza di avviamento rispetto alle batterie tradizionali
- > Durata ai cicli di carica/scarica superiore, più che doppia rispetto a quella delle migliori batterie tradizionali
- > Accettazione di carica superiore, in particolare in condizioni dinamiche
- > Elevata resistenza alle scariche profonde
- > Elevata resistenza alle vibrazioni

- > VRLA AGM battery with gas recombination
- > Absolutely maintenance-free
- > **Sealed** lid
- > Greater starting power than traditional batteries
- > Better endurance to charge/discharge cycles, more than double that of the best traditional batteries
- > Better charge acceptance, particularly in dynamic conditions
- > High resistance to intense discharges
- > High vibration resistance

- > Batterie VRLA AGM à recombinaison de gaz
- > Sans aucun entretien
- > Couvercle **« Sealed » (scellé)**
- > Puissance de démarrage supérieure par rapport aux batteries traditionnelles
- > Durée aux cycles de charge/décharge plus de deux fois supérieure par rapport à celle des meilleures batteries traditionnelles
- > Acceptation de charge supérieure, en particulier dans des conditions dynamiques
- > Résistance élevée aux décharges profondes
- > Résistance élevée aux vibrations

- > Batterie VRLA AGM mit Gasrekombination
- > Absolut wartungsfrei
- > Deckel **„gasdicht“**
- > Höhere Startleistung als herkömmliche Batterien
- > Erhöhte Zyklenfestigkeit, mehr als doppelt so hoch als bei den besten herkömmlichen Batterien
- > Erhöhte Ladeakzeptanz, besonders unter dynamischen Bedingungen
- > Erhöhte Entladungsfestigkeit
- > Erhöhte Rüttelfestigkeit

- > Batería VRLA AGM de nueva combinación de gas
- > No necesita ningún tipo de mantenimiento
- > Tapa **“Sellada”**
- > Mayor potencia de arranque respecto a las baterías tradicionales
- > Duración ante los ciclos de carga/descarga superior, más de el doble que las mejores baterías tradicionales
- > Aceptación de carga superior, en especial, en condiciones dinámicas
- > Elevada resistencia a las descargas profundas
- > Elevada resistencia a las vibraciones

- > Аккумуляторные батареи типа VRLA AGM с рекомбинацией газов
- > Техобслуживание не требуется
- > Герметизированная крышка (**Sealed**)
- > Повышенная пусковая мощность по сравнению с традиционными батареями
- > Количество циклов разряда-заряда более чем в два раза выше по сравнению с лучшими моделями традиционных батарей
- > Более высокий КПД запасаемого заряда (емкость), особенно при быстромеменяющихся условиях
- > Повышенная стойкость к глубокому разряду
- > Повышенная вибростойкость

ENERGYCUBE APC



- > Batteria ad acido libero a ridotta manutenzione con tappi anti leakage a tenuta
- > Innovativo doppio sistema di bloccaggio delle piastre all'interno della cella per una elevata resistenza alle vibrazioni e conforme ai più elevati standard del settore automotive
- > Buona potenza di avviamento
- > Elevata accettazione di carica
- > Buona resistenza alle scariche profonde
- > Estrema durata ai cicli di carica/scarica
- > Elevata resistenza alle vibrazioni

- > Low-maintenance free acid battery with sealed anti-leakage caps
- > Innovative dual plate blocking system inside the cell that provides high resistance to vibrations and that complies with the highest automotive industry standards
- > Good starting power
- > High charge acceptance
- > Good resistance to intense discharges
- > Extreme endurance to charge/discharge cycles
- > High vibration resistance

- > Batterie à acide libre à entretien réduit avec bouchons anti-fuites étanches
- > Double système de blocage des plaques à l'intérieur de la cellule innovant pour une résistance élevée aux vibrations et conforme aux normes les plus strictes du secteur automobile
- > Bonne puissance de démarrage
- > Acceptation élevée de charge
- > Bonne résistance aux décharges profondes
- > Durée extrême aux cycles de charge/décharge
- > Résistance élevée aux vibrations

- > Wartungsarme Batterie mit freier Säure und austrittsfesten Dichtungsstopfen
- > Innovatives zweifaches Platten-Befestigungssystem an der Zelleninnenseite für eine erhöhte Rüttelfestigkeit entsprechend der strengsten Vorschriften im Automobilssektor
- > Gute Startleistung
- > Erhöhte Ladeakzeptanz
- > Gute Entladungsfestigkeit
- > Extreme Zyklenfestigkeit
- > Erhöhte Rüttelfestigkeit

- > Bateria de ácido libre de mantenimiento reducido con tapones antifugas estancos
- > Innovador doble sistema de bloqueo de las placas en el interior de la célula para una elevada resistencia a las vibraciones y conforme a los estándares más elevados del sector de la automoción
- > Buena potencia de arranque
- > Elevada aceptación de carga
- > Buena resistencia a las descargas profundas
- > Extrema duración ante los ciclos de carga/descarga
- > Elevada resistencia a las vibraciones

- > Традиционные малообслуживаемые аккумуляторные батареи, с герметичными пробками
- > Новаторская двойная система крепления пластин внутри ячейки, обеспечивающая повышенную вибростойкость и соответствующая самым жестким стандартам в автомобильной отрасли
- > Хороший показатель пусковой мощности
- > Повышенный КПД запасаемого заряда (емкость)
- > Хорошие показатели стойкости к глубокому разряду
- > Очень высокое количество циклов разряда-заряда
- > Повышенная вибростойкость

ENERGYCUBE RST



- > Batteria ad acido libero a ridotta manutenzione, non richiede rabbocchi ma i tappi lo consentono se necessario
- > Coperchio standard
- > Grande potenza di avviamento
- > Buona accettazione di carica
- > Buona durata ai cicli di carica/scarica
- > Resistente alle vibrazioni

- > Wartungsarme Batterie mit freier Säure, kein Nachfüllen nötig, dennoch über die Stopfen möglich
- > Standarddeckel
- > Große Startleistung
- > Gute Ladeakzeptanz
- > Gute Zyklenfestigkeit
- > Rüttelfest

- > Low-maintenance free acid battery requiring no top-ups, but the caps will allow it to be topped up if necessary
- > Standard lid
- > Great starting power
- > Good charge acceptance
- > Good endurance to charge/discharge cycles
- > Resistant to vibrations

- > Batería de ácido libre de mantenimiento reducido, no necesita repostado, pero los tapones lo permiten si es necesario
- > Tapa estándar
- > Gran potencia de arranque
- > Buena aceptación de carga
- > Buena duración ante los ciclos de carga/descarga
- > Resistente a las vibraciones

- > Batterie à acide libre à entretien réduit, ne nécessite aucun appoint mais les bouchons le permettent si nécessaire
- > Couvercle standard
- > Forte puissance de démarrage
- > Bonne acceptation de charge
- > Bonne durée aux cycles de charge/décharge
- > Résistante aux vibrations

- > Традиционные малообслуживаемые аккумуляторные батареи, доливка не требуется, но возможна при необходимости (пробки позволяют это сделать)
- > Крышка стандартного исполнения
- > Очень высокая пусковая мощность
- > Хороший уровень КПД запасаемого заряда (емкость)
- > Хороший показатель количества циклов разряда-заряда
- > Хорошая вибростойкость

12 VOLT - POWERCUBE - AGM - ABSORBENT GLASS MAT

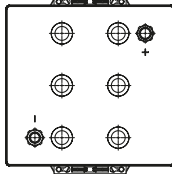
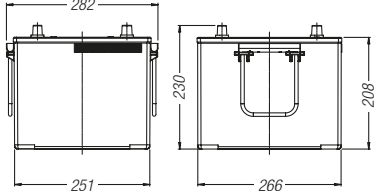
Short Code	Gruppo Dimensionale Case size Dimensions Größe Formato dimensional Конструктивное исполнение	ETN	DIN	Capacità Capacity Capacité Kapazität Capacidad Емкость (C20) Ah	CCA EN A	Poli tipo Terminal Borne Poltyp Polo Клемма	Schemae Polarità Layout Schéma Schaltung Esquema Схема	Dimensioni Dimensions Dimensions Abmessungen Dimensiones Габариты (mm)
D7 125 AGM	D7	-	-	125	1100 sae	1	 <p style="text-align: center;">2</p>	 <p style="text-align: center;">B00</p>

12 VOLT - POWERCUBE - APC - ADVANCED POWER CYCLING

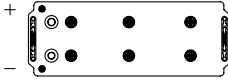
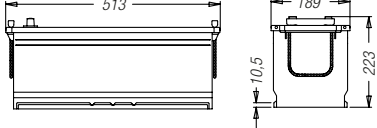
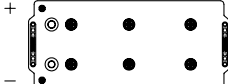
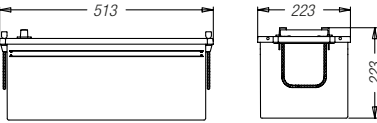
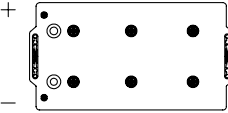
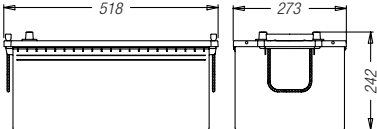
Short Code	Gruppo Dimensionale Case size Dimensions Größe Formato dimensional Конструктивное исполнение	ETN	DIN	Capacità Capacity Capacité Kapazität Capacidad Емкость (C20) Ah	CCA EN A	Poli tipo Terminal Borne Poltyp Polo Клемма	Schemae Polarità Layout Schéma Schaltung Esquema Схема	Dimensioni Dimensions Dimensions Abmessungen Dimensiones Габариты (mm)
A 135 APC	A	635 105 085	63530	135	850	1	 <p style="text-align: center;">3</p>	 <p style="text-align: center;">B01 (Int.)</p>
B 180 APC	B	680 032 100	68032	180	1000	1	 <p style="text-align: center;">3</p>	 <p style="text-align: center;">B00</p>
CX 225 APC	C	725 012 115	72512	225	1150	1	 <p style="text-align: center;">3</p>	 <p style="text-align: center;">B00</p>

12 VOLT - POWERCUBE - EHD - ENHANCED HEAVY DUTY

Short Code	Gruppo Dimensionale Case size Dimensions Größe Formato dimensional Конструктивное исполнение	ETN	DIN	Capacità Capacity Capacité Kapazität Capacidad Емкость (C20) Ah	CCA EN A	Poli tipo Terminal Borne Poltyp Polo Клемма	Schemae Polarità Layout Schéma Schaltung Esquema Схема	Dimensioni Dimensions Dimensions Abmessungen Dimensiones Габариты (mm)
D11 110 EHD	MCD110	610 107 080	61040	110	800	1	 3	 B03
A 120 EHD	A	620 108 085	62040	120	850	1	 3	 B01 (Int.)
MC12 120 EHD	MAC120	620 107 085	61087	120	850	1	 4	 B03
MT 132 EHD	MAT132	632 101 095	63211	132	950	1	 0	 B01
D11 135 EHD	MCD110	635 106 095	63543	135	950	1	 3	 B03
A 140 EHD	A	640 102 095	64020	140	950	1	 3	 B01 (Int.)
B 148 EHD	B	648 102 100	-	148	1000	1	 3	 B00
D14 148 EHD	MCD143	648 101 100	64329	148	1000	1	 3	 B01 - INT.
B 160 EHD	B	660 104 105	67018	170	1050	1	 3	 B00

12 VOLT - POWERCUBE - EHD - ENHANCED HEAVY DUTY

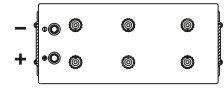
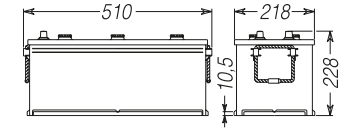
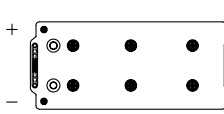
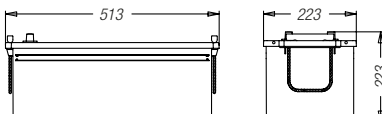
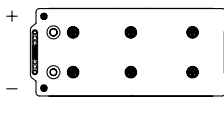
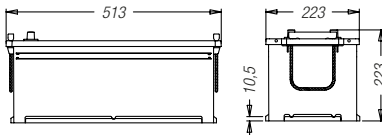
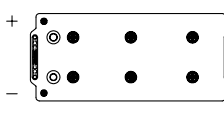
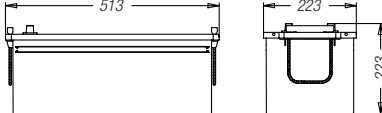
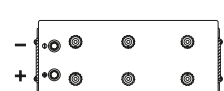
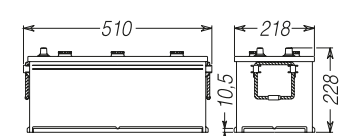
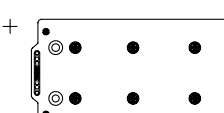
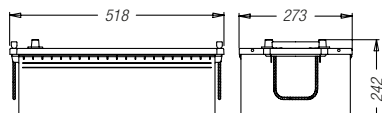
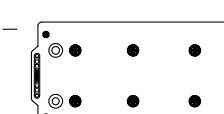
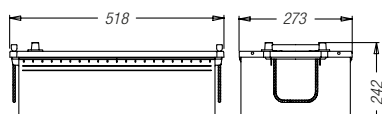
Short Code	Gruppo Dimensionale Case size Dimensions Größe Formato dimensional Конструктивное исполнение	ETN	DIN	Capacità Capacity Capacité Kapazität Capacidad Емкость (C20) Ah	CCA EN A	Poli tipo Terminal Borne Poltyp Polo Клемма	Schemae Polarità Layout Schéma Schaltung Esquema Схема	Dimensioni Dimensions Dimensions Abmessungen Dimensiones Габариты (mm)
MC15 160 EHD	MAC154	660 103 105	66519	160	1050	1	 <p style="text-align: center;">4</p>	 <p style="text-align: center;">B03</p>
B 180 EHD	B	680 104 110	68022	180	1100	1	 <p style="text-align: center;">3</p>	 <p style="text-align: center;">B00</p>
B 180 EHD (B03)	B	-	-	180	1100	1	 <p style="text-align: center;">3</p>	 <p style="text-align: center;">B03</p>
B 190 EHD	B	-	-	190	1100	1	 <p style="text-align: center;">3</p>	 <p style="text-align: center;">B03</p>
MC15 185 EHD	MAC154	685 101 120	-	185	1200	1	 <p style="text-align: center;">4</p>	 <p style="text-align: center;">B03</p>
CX 200 EHD	C	700 108 115	71014	200	1150	1	 <p style="text-align: center;">3</p>	 <p style="text-align: center;">B00</p>
C 200 EHD	C	700 109 115	71015	200	1150	1	 <p style="text-align: center;">4</p>	 <p style="text-align: center;">B00</p>

12 VOLT - ENERGYCUBE - RST - RELIABLE STARTER (DRY)

Short Code	Gruppo Dimensionale Case size Dimensions Größe Formato dimensional Конструктивное исполнение	ETN	DIN	Capacità Capacity Capacité Kapazität Capacidad Емкость (C20) Ah	CCA EN A	Poli tipo Terminal Borne Poltyp Polo Клемма	Schemae Polarità Layout Schéma Schaltung Esquema Схема	Dimensioni Dimensions Dimensions Abmessungen Dimensiones Габариты (mm)
A 120 RSTd	A	620 108 085	62040	120	850	1		
B 160 RSTd	B	660 104 105	67018	160	1050	1		
B 180 RSTd	B	680 104 110	68022	180	1100	1		
CX 200 RSTd	C	700 108 115	71014	200	1150	1		

12 VOLT - ENERGYCUBE - RST - RELIABLE STARTER

Short Code	Gruppo Dimensionale Case size Dimensions Größe Formato dimensional Конструктивное исполнение	ETN	DIN	Capacità Capacity Capacité Kapazität Capacidad Емкость (C20) Ah	CCA EN A	Poli tipo Terminal Borne Poltyp Polo Клемма	Schemae Polarità Layout Schéma Schaltung Esquema Схема	Dimensioni Dimensions Dimensions Abmessungen Dimensiones Габариты (mm)
G28 100 RST	GR28	-	60032	100	720	1		
G28X 100 RST	GR28	-	60033	100	720	1		
CB 110 RST	COM100	-	60528	110	850	1		

12 VOLT - ENERGYCUBE - RST - RELIABLE STARTER

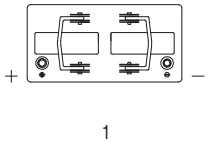
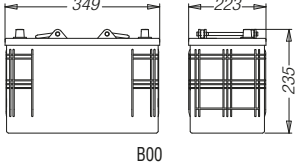
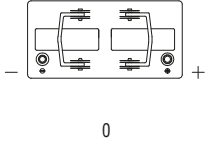
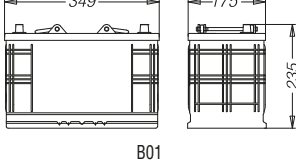
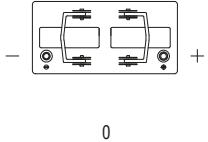
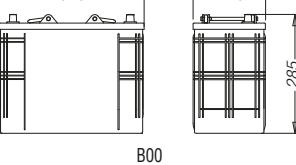
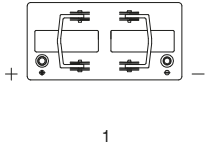
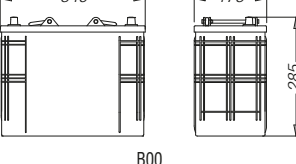
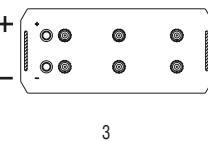
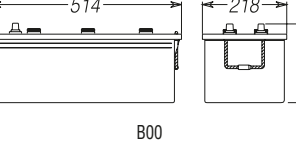
Short Code	Gruppo Dimensionale Case size Dimensions Größe Formato dimensional Конструктивное исполнение	ETN	DIN	Capacità Capacity Capacité Kapazität Capacidad Емкость (C20) Ah	CCA EN A	Poli tipo Terminal Borne Poltyp Polo Клемма	Schemae Polarità Layout Schéma Schaltung Esquema Схема	Dimensioni Dimensions Dimensions Abmessungen Dimensiones Габариты (mm)
CBX 110 RST	COM100	-	60527	110	850	1		
CB 110 RST (B01)	COM100	-	-	110	850	1		
CH 125 RST	COM125	625 103 076	62512	125	760	1		
CHX 125 RST	COM125	625 104 076	62514	125	760	1		
MC 130 RST	MC 130	630 104 095	63013	130	950	1		

12 VOLT - ENERGYCUBE - RST - RELIABLE STARTER (DRY)

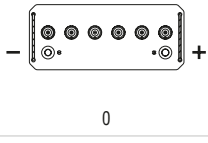
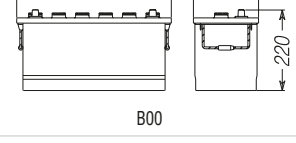
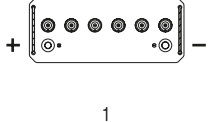
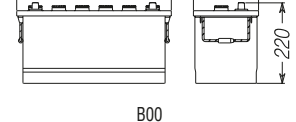
Short Code	Gruppo Dimensionale Case size Dimensions Größe Formato dimensional Конструктивное исполнение	ETN	DIN	Capacità Capacity Capacité Kapazität Capacidad Емкость (C20) Ah	CCA EN A	Poli tipo Terminal Borne Poltyp Polo Клемма	Schemae Polarità Layout Schéma Schaltung Esquema Схема	Dimensioni Dimensions Dimensions Abmessungen Dimensiones Габариты (mm)
AT 100 RSTd	AT 100	600 026 060	60026	100	600	1		
ATX 100 RSTd	AT 100	600 035 060	60035	100	600	1		

**POLARITÀ - LAYOUT - SCHÉMA
SCHALTUNG - ESQUEMA - CXEMA**

12 Volt



**TIPO POLO - TERMINAL - BORNE
POLTYPE - POLO - КЛЕММА**

TERMINAL 1

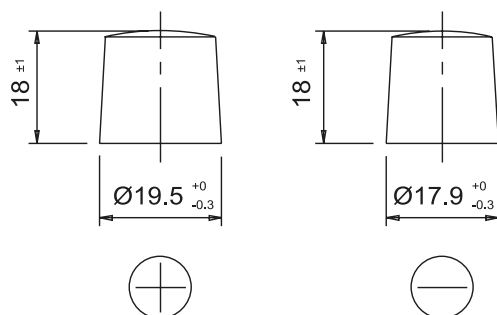

**FISSAGGI ALLA BASE - HOLD DOWN - FIXATION
BODENLEISTEN - TIPO DE ENVASE - ЗАЖИМ**

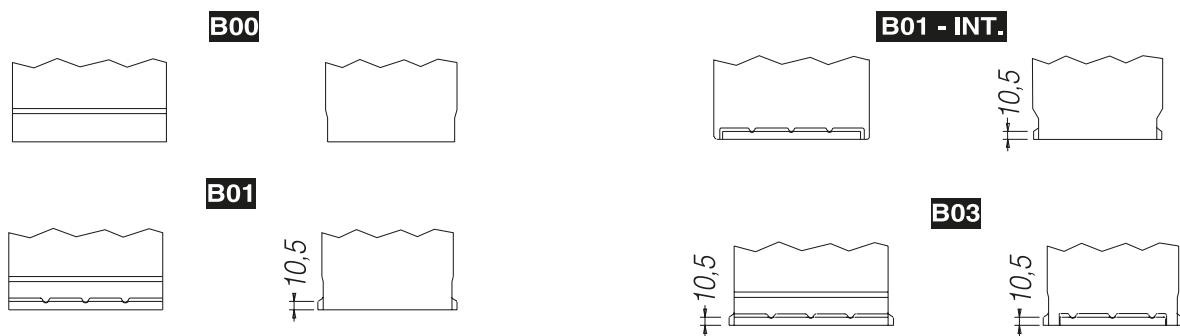

**TABELLA COMPARATIVA - CROSS REFERENCE LIST - TABLEAU D'ÉQUIVALENCES
UMSCHLÜSSELUNGSLISTE - CRUCE DE REFERENCIAS - ТАБЛИЦА СРАВНЕНИЯ**

12 VOLT - POWERCUBE - AGM - ABSORBENT GLASS MAT

FIAMM	AAA	BÄREN	BOSCH	EXIDE	M. MARELLI	TUDOR	URANIO	VARTA
D7 125 AGM								

12 VOLT - POWERCUBE - APC - ADVANCED POWER CYCLING

FIAMM	AAA	BÄREN	BOSCH	EXIDE	M. MARELLI	TUDOR	URANIO	VARTA
A 135 APC 635 105 085	A 135 SHD	A 135 SHD	645 400 080	EE1403 EF1453	SHD160S2 SHDI140S	TE1403 TF1453	935.850S	645 400 080
B 180 APC 680 032 100	B 180 SHD	B 180 SHD	680 108 100	EE1853 EF1853	SHD180S2 SHDI180S	TE1853 TF1853	980.1000S	680 108 100
CX 225 APC 725 012 115	CX 225 SHD	CX 225 SHD	725 103 115	EE2253 EF2353	SHD225S2 SHDI220S	TE2253 TF2353	725.1150S	725 103 115

12VOLT - POWERCUBE - EHD - ENHANCED HEAVY DUTY

FIAMM	AAA	BÄREN	BOSCH	EXIDE	M.MARELLI	TUDOR	URANIO	VARTA
D11110EHD 610107080			610013076					610013076
A120EHD 620108085	A120	A120	620045068	EH1203	HD125S2	TH1203	920.850S	620045068
MC12120EHD 620107085	MC12120	MC12120	620109076	EG1406 EH1206	HD120D2	TG1406 TH1206	920.850D	620109076
MT132EHD 632101095	MT132	MT132	643107090	EG1402	HD140D2	TG1402	932.950D	643107090
D11135EHD 635106095			635052100	EG1355		TG1355		635052100
A140EHD 640102095		A140	640103080 640400080	EG1403		TG1403	940.950S	640103080 640400080
B148EHD 648102100					HD155S2			
D14148EHD 648101100			643033095	EG1705		TG1705		643033095
B160EHD 660104105	B160	B160	655013090	EH1553	HD155S2	TH1553	960.1050S	655013090
MC15160EHD 660103105	MC15160	MC15160	655104090	EH1556	HD155D2	HD155D2	960.1050D	655104090
B180EHD 680104110	B180	B180	670103100	EG1803	HD180S2	TG1803	980.1100S	670103100
B180EHD B03			670104100					670104100

**TABELLA COMPARATIVA - CROSS REFERENCE LIST - TABLEAU D'ÉQUIVALENCES
UMSCHLÜSSELUNGSLISTE - CRUCE DE REFERENCIAS - ТАБЛИЦА СРАВНЕНИЯ**

12VOLT - POWERCUBE - EHD - ENHANCED HEAVY DUTY

FIAMM	AAA	BÄREN	BOSCH	EXIDE	M.MARELLI	TUDOR	URANIO	VARTA
B190EHD								
MC15185EHD 685101120	MC15185	MC15185		EG1806	HD180D2	TG1806	985.1200D	
CX200EHD 700108115	CX200	CX200	715400115 700038105	EG2153	HD200SC2	TG2153	700.1150S	715400115 700038105
C200EHD 700109115				EG2154	HD200DC2	TG2154		

12 VOLT - ENERGYCUBE - APC - ADVANCED POWER CYCLING

FIAMM	AAA	BÄREN	BOSCH	EXIDE	M. MARELLI	TUDOR	URANIO	VARTA
B 185 APC								
CX 220 APC								

12 VOLT - ENERGYCUBE - APC - ADVANCED POWER CYCLING

FIAMM	AAA	BÄREN	BOSCH	EXIDE	M. MARELLI	TUDOR	URANIO	VARTA
G28 100 RST	G28 100	G28 100	600 123 072		ETS100ND		Starter 600.720D	600 123 072
G28X 100 RST	G28X 100	G28X 100			ES100720S		Starter 600.720S	
CB 110 RST	CB 110	CB 110	610 047 068 590 040 054	EG1100	HD105D 246850HD	TG1100	Starter 610.850D	610 047 068 590 040 054
CBX 110 RST	CBX 110		610 048 068 590 041 054	EG1101		TG1101	Starter 610.850S	610 048 068 590 041 054
CB 110 RST B01	CB 110 B01	CB 110 B01	610 404 068	EG1102	HD110D2 246800.1HD	TG1102	Starter 610.850 B01	610 404 068
CH 125 RST 625 103 076	CH 125	CH 125	625 012 072	EG1250	HD125D2	TG1250	Starter 625.760	625 012 072
CHX 125 RST 625 104 076			625 014 072					625 014 072
MC 130 RST 630 104 095			630 014 068	EG1353		TG1353		630 014 068
AT 100 RSTd 600 026 060			600 047 060 610 050 085					600 047 060 610 050 085
ATX 100 RSTd 600 035 060			600 035 060					600 035 060

MARCHIO E MODELLO - MAKE AND MODEL MARQUE ET MODÈLE - MARKE UND MODELL MARCA Y MODELO - МАРКА И МОДЕЛЬ	Periodo Period	powerCUBE		energyCUBE	
		APC	EHD	APC	RST
ASTRA					
HD 7 42.42	01/1996 -	B 180 APC	B 180 EHD / B 160 EHD	B 185 APC	
HD 7 42.42 T	01/1996 -	B 180 APC	B 180 EHD / B 160 EHD	B 185 APC	
HD 7 44.34	01/1996 -	B 180 APC	B 180 EHD / B 160 EHD	B 185 APC	
HD 7 44.38	01/1996 -	B 180 APC	B 180 EHD / B 160 EHD	B 185 APC	
HD 7 44.38 T	01/1996 -	B 180 APC	B 180 EHD / B 160 EHD	B 185 APC	
HD 7 44.42 T	01/1996 -	B 180 APC	B 180 EHD / B 160 EHD	B 185 APC	
HD 7 64.34	01/1996 -	B 180 APC	B 180 EHD / B 160 EHD	B 185 APC	
HD 7 64.38	01/1996 -	B 180 APC	B 180 EHD / B 160 EHD	B 185 APC	
HD 7 64.38 T	01/1996 -	B 180 APC	B 180 EHD / B 160 EHD	B 185 APC	
HD 7 64.42	01/1996 -	B 180 APC	B 180 EHD / B 160 EHD	B 185 APC	
HD 7 64.42 T	01/1996 -	B 180 APC	B 180 EHD / B 160 EHD	B 185 APC	
HD 7 64.45	01/1996 -	B 180 APC	B 180 EHD / B 160 EHD	B 185 APC	
HD 7 64.45 T	01/1996 -	B 180 APC	B 180 EHD / B 160 EHD	B 185 APC	
HD 7 64.47	01/1996 -	B 180 APC	B 180 EHD / B 160 EHD	B 185 APC	
HD 7 64.52	01/1996 -	B 180 APC	B 180 EHD / B 160 EHD	B 185 APC	
HD 7 64.52 T	01/1996 -	B 180 APC	B 180 EHD / B 160 EHD	B 185 APC	
HD 7 66.38	01/1996 -	B 180 APC	B 180 EHD / B 160 EHD	B 185 APC	
HD 7 66.42	01/1996 -	B 180 APC	B 180 EHD / B 160 EHD	B 185 APC	
HD 7 66.42 T	01/1996 -	B 180 APC	B 180 EHD / B 160 EHD	B 185 APC	
HD 7 66.45	01/1996 -	B 180 APC	B 180 EHD / B 160 EHD	B 185 APC	
HD 7 66.45 T	01/1996 -	B 180 APC	B 180 EHD / B 160 EHD	B 185 APC	
HD 7 66.52	01/1996 -	B 180 APC	B 180 EHD / B 160 EHD	B 185 APC	
HD 7 66.52 T	01/1996 -	B 180 APC	B 180 EHD / B 160 EHD	B 185 APC	
HD 7 84.47	01/1996 -	B 180 APC	B 180 EHD / B 160 EHD	B 185 APC	
HD 7 84.52	01/1996 -	B 180 APC	B 180 EHD / B 160 EHD	B 185 APC	
HD 7 86.42	01/1996 -	B 180 APC	B 180 EHD / B 160 EHD	B 185 APC	
HD 7 86.45	01/1996 -	B 180 APC	B 180 EHD / B 160 EHD	B 185 APC	
HD 7 86.52	01/1998 -	B 180 APC	B 180 EHD / B 160 EHD	B 185 APC	
HD 7-C 42.36	01/2000 -	B 180 APC	B 180 EHD / B 160 EHD	B 185 APC	
HD 7-C 42.36 T	01/2000 -	B 180 APC	B 180 EHD / B 160 EHD	B 185 APC	
HD 7-C 42.40	01/2000 -	B 180 APC	B 180 EHD / B 160 EHD	B 185 APC	
HD 7-C 42.40 T	01/2000 -	B 180 APC	B 180 EHD / B 160 EHD	B 185 APC	
HD 7-C 42.45	01/2000 -	B 180 APC	B 180 EHD / B 160 EHD	B 185 APC	
HD 7-C 42.45 T	01/2000 -	B 180 APC	B 180 EHD / B 160 EHD	B 185 APC	
HD 7-C 44.36	01/2000 -	B 180 APC	B 180 EHD / B 160 EHD	B 185 APC	
HD 7-C 44.36 T	01/2000 -	B 180 APC	B 180 EHD / B 160 EHD	B 185 APC	
HD 7-C 44.40	01/2000 -	B 180 APC	B 180 EHD / B 160 EHD	B 185 APC	
HD 7-C 44.40 T	01/2000 -	B 180 APC	B 180 EHD / B 160 EHD	B 185 APC	
HD 7-C 44.45	01/2000 -	B 180 APC	B 180 EHD / B 160 EHD	B 185 APC	
HD 7-C 44.45 T	01/2000 -	B 180 APC	B 180 EHD / B 160 EHD	B 185 APC	
HD 7-C 64.36	01/2000 -	B 180 APC	B 180 EHD / B 160 EHD	B 185 APC	
HD 7-C 64.36 T	01/2000 -	B 180 APC	B 180 EHD / B 160 EHD	B 185 APC	
HD 7-C 64.40	01/2000 -	B 180 APC	B 180 EHD / B 160 EHD	B 185 APC	
HD 7-C 64.40 T	01/2000 -	B 180 APC	B 180 EHD / B 160 EHD	B 185 APC	
HD 7-C 64.45	01/2000 -	B 180 APC	B 180 EHD / B 160 EHD	B 185 APC	

MARCHIO E MODELLO - <i>MAKE AND MODEL</i> MARQUE ET MODÈLE - <i>MARKE UND MODELL</i> MARCA Y MODELO - <i>МАРКА И МОДЕЛЬ</i>	Periodo <i>Period</i>	powerCUBE		energyCUBE	
		APC	EHD	APC	RST
ASTRA <small>cont.</small>					
HD 7-C 64.45 T	01/2000 -	B 180 APC	B 180 EHD / B 160 EHD	B 185 APC	
HD 7-C 64.50	01/2000 -	B 180 APC	B 180 EHD / B 160 EHD	B 185 APC	
HD 7-C 64.50 T	01/2000 -	B 180 APC	B 180 EHD / B 160 EHD	B 185 APC	
HD 7-C 66.36	01/2000 -	B 180 APC	B 180 EHD	B 185 APC	
HD 7-C 66.36 T	01/2000 -	B 180 APC	B 180 EHD	B 185 APC	
HD 7-C 66.40	01/2000 -	B 180 APC	B 180 EHD	B 185 APC	
HD 7-C 66.40 T	01/2000 -	B 180 APC	B 180 EHD	B 185 APC	
HD 7-C 66.45	01/2000 -	B 180 APC	B 180 EHD	B 185 APC	
HD 7-C 66.45 T	01/2000 -	B 180 APC	B 180 EHD	B 185 APC	
HD 7-C 66.50	01/2000 -	B 180 APC	B 180 EHD	B 185 APC	
HD 7-C 66.50 T	01/2000 -	B 180 APC	B 180 EHD	B 185 APC	
HD 7-C 84.36	01/2000 -	B 180 APC	B 180 EHD / B 160 EHD	B 185 APC	
HD 7-C 84.40	01/2000 -	B 180 APC	B 180 EHD / B 160 EHD	B 185 APC	
HD 7-C 84.45	01/2000 -	B 180 APC	B 180 EHD / B 160 EHD	B 185 APC	
HD 7-C 84.50	01/2000 -	B 180 APC	B 180 EHD / B 160 EHD	B 185 APC	
HD 7-C 86.40	01/2000 -	B 180 APC	B 180 EHD	B 185 APC	
HD 7-C 86.45	01/2000 -	B 180 APC	B 180 EHD	B 185 APC	
HD 7-C 86.50	01/2000 -	B 180 APC	B 180 EHD	B 185 APC	
HD 7-C 88.45	01/2000 -	B 180 APC	B 180 EHD	B 185 APC	
HD 7-C 88.50	01/2000 -	B 180 APC	B 180 EHD	B 185 APC	
HD 8 42.33	06/2007 -	B 180 APC	B 180 EHD	B 185 APC	
HD 8 42.36	01/2005 -	B 180 APC	B 180 EHD	B 185 APC	
HD 8 42.36	06/2007 -	B 180 APC	B 180 EHD	B 185 APC	
HD 8 42.36 T	01/2005 -	B 180 APC	B 180 EHD	B 185 APC	
HD 8 42.40	01/2005 -	B 180 APC	B 180 EHD	B 185 APC	
HD 8 42.40 T	01/2005 -	B 180 APC	B 180 EHD	B 185 APC	
HD 8 42.41	03/2007 -	B 180 APC	B 180 EHD	B 185 APC	
HD 8 42.41 T	03/2007 -	B 180 APC	B 180 EHD	B 185 APC	
HD 8 42.44	03/2007 -	B 180 APC	B 180 EHD	B 185 APC	
HD 8 42.44 T	03/2007 -	B 180 APC	B 180 EHD	B 185 APC	
HD 8 42.45	01/2005 -	B 180 APC	B 180 EHD	B 185 APC	
HD 8 42.45 T	01/2005 -	B 180 APC	B 180 EHD	B 185 APC	
HD 8 42.48	03/2007 -	B 180 APC	B 180 EHD	B 185 APC	
HD 8 42.48 T	03/2007 -	B 180 APC	B 180 EHD	B 185 APC	
HD 8 42.50	01/2005 -	B 180 APC	B 180 EHD	B 185 APC	
HD 8 42.50 T	01/2005 -	B 180 APC	B 180 EHD	B 185 APC	
HD 8 42.52 T	03/2007 -	B 180 APC	B 180 EHD	B 185 APC	
HD 8 42.56 T	03/2007 -	B 180 APC	B 180 EHD	B 185 APC	
HD 8 44.33	06/2007 -	B 180 APC	B 180 EHD	B 185 APC	
HD 8 44.36	01/2005 -	B 180 APC	B 180 EHD	B 185 APC	
HD 8 44.36	06/2007 -	B 180 APC	B 180 EHD	B 185 APC	
HD 8 44.36 T	01/2005 -	B 180 APC	B 180 EHD	B 185 APC	
HD 8 44.40 T	01/2005 -	B 180 APC	B 180 EHD	B 185 APC	
HD 8 44.40, 44.41	01/2005 -	B 180 APC	B 180 EHD	B 185 APC	
HD 8 44.41 T	03/2007 -	B 180 APC	B 180 EHD	B 185 APC	

MARCHIO E MODELLO - MAKE AND MODEL MARQUE ET MODÈLE - MARKE UND MODELL MARCA Y MODELO - МАРКА И МОДЕЛЬ	Periodo Period	powerCUBE		energyCUBE	
		APC	EHD	APC	RST
ASTRA <small>cont.</small>					
HD 8 44.44 T	03/2007 -	B 180 APC	B 180 EHD	B 185 APC	
HD 8 44.44, 44.45	01/2005 -	B 180 APC	B 180 EHD	B 185 APC	
HD 8 44.45 T	01/2005 -	B 180 APC	B 180 EHD	B 185 APC	
HD 8 44.48	03/2007 -	B 180 APC	B 180 EHD	B 185 APC	
HD 8 44.48 T	03/2007 -	B 180 APC	B 180 EHD	B 185 APC	
HD 8 44.50	01/2005 -	B 180 APC	B 180 EHD	B 185 APC	
HD 8 44.50 T	01/2005 -	B 180 APC	B 180 EHD	B 185 APC	
HD 8 44.52 T	03/2007 -	B 180 APC	B 180 EHD	B 185 APC	
HD 8 44.56 T	03/2007 -	B 180 APC	B 180 EHD	B 185 APC	
HD 8 64.36	01/2005 -	B 180 APC	B 180 EHD	B 185 APC	
HD 8 64.36 T	01/2005 -	B 180 APC	B 180 EHD	B 185 APC	
HD 8 64.40	01/2005 -	B 180 APC	B 180 EHD	B 185 APC	
HD 8 64.40 T	01/2005 -	B 180 APC	B 180 EHD	B 185 APC	
HD 8 64.41	03/2007 -	B 180 APC	B 180 EHD	B 185 APC	
HD 8 64.41 T	03/2007 -	B 180 APC	B 180 EHD	B 185 APC	
HD 8 64.44	03/2007 -	B 180 APC	B 180 EHD	B 185 APC	
HD 8 64.44 T	03/2007 -	B 180 APC	B 180 EHD	B 185 APC	
HD 8 64.45	01/2005 -	B 180 APC	B 180 EHD	B 185 APC	
HD 8 64.45 T	01/2005 -	B 180 APC	B 180 EHD	B 185 APC	
HD 8 64.48	03/2007 -	B 180 APC	B 180 EHD	B 185 APC	
HD 8 64.48 T	03/2007 -	B 180 APC	B 180 EHD	B 185 APC	
HD 8 64.50	01/2005 -	B 180 APC	B 180 EHD	B 185 APC	
HD 8 64.50 T	01/2005 -	B 180 APC	B 180 EHD	B 185 APC	
HD 8 64.52	03/2007 -	B 180 APC	B 180 EHD	B 185 APC	
HD 8 64.52 T	03/2007 -	B 180 APC	B 180 EHD	B 185 APC	
HD 8 64.56	03/2007 -	B 180 APC	B 180 EHD	B 185 APC	
HD 8 64.56 T	03/2007 -	B 180 APC	B 180 EHD	B 185 APC	
HD 8 66.36	01/2005 -	B 180 APC	B 180 EHD	B 185 APC	
HD 8 66.36 T	01/2005 -	B 180 APC	B 180 EHD	B 185 APC	
HD 8 66.40	01/2005 -	B 180 APC	B 180 EHD	B 185 APC	
HD 8 66.40 T	01/2005 -	B 180 APC	B 180 EHD	B 185 APC	
HD 8 66.41	03/2007 -	B 180 APC	B 180 EHD	B 185 APC	
HD 8 66.41 T	03/2007 -	B 180 APC	B 180 EHD	B 185 APC	
HD 8 66.44	03/2007 -	B 180 APC	B 180 EHD	B 185 APC	
HD 8 66.44 T	03/2007 -	B 180 APC	B 180 EHD	B 185 APC	
HD 8 66.45	01/2005 -	B 180 APC	B 180 EHD	B 185 APC	
HD 8 66.45 T	01/2005 -	B 180 APC	B 180 EHD	B 185 APC	
HD 8 66.48	03/2007 -	B 180 APC	B 180 EHD	B 185 APC	
HD 8 66.48 T	03/2007 -	B 180 APC	B 180 EHD	B 185 APC	
HD 8 66.50	01/2005 -	B 180 APC	B 180 EHD	B 185 APC	
HD 8 66.50 T	01/2005 -	B 180 APC	B 180 EHD	B 185 APC	
HD 8 66.52	03/2007 -	B 180 APC	B 180 EHD	B 185 APC	
HD 8 66.52 T	03/2007 -	B 180 APC	B 180 EHD	B 185 APC	
HD 8 66.54	03/2007 -	B 180 APC	B 180 EHD	B 185 APC	
HD 8 66.56	03/2007 -	B 180 APC	B 180 EHD	B 185 APC	

MARCHIO E MODELLO - MAKE AND MODEL MARQUE ET MODÈLE - MARKE UND MODELL MARCA Y MODELO - МАРКА И МОДЕЛЬ	Periodo Period	powerCUBE		energyCUBE	
		APC	EHD	APC	RST
ASTRA					
cont.					
HD 8 66.56 T	03/2007 -	B 180 APC	B 180 EHD	B 185 APC	
HD 8 84.36	01/2005 -	B 180 APC	B 180 EHD	B 185 APC	
HD 8 84.40, 84.41	01/2005 -	B 180 APC	B 180 EHD	B 185 APC	
HD 8 84.44, 84.45	01/2005 -	B 180 APC	B 180 EHD	B 185 APC	
HD 8 84.48	03/2007 -	B 180 APC	B 180 EHD	B 185 APC	
HD 8 84.50	01/2005 -	B 180 APC	B 180 EHD	B 185 APC	
HD 8 84.52	03/2007 -	B 180 APC	B 180 EHD	B 185 APC	
HD 8 84.54	01/2005 -	B 180 APC	B 180 EHD	B 185 APC	
HD 8 84.56	03/2007 -	B 180 APC	B 180 EHD	B 185 APC	
HD 8 86.40	01/2005 -	B 180 APC	B 180 EHD	B 185 APC	
HD 8 86.44, 86.45	01/2005 -	B 180 APC	B 180 EHD	B 185 APC	
HD 8 86.48	03/2007 -	B 180 APC	B 180 EHD	B 185 APC	
HD 8 86.50	01/2005 -	B 180 APC	B 180 EHD	B 185 APC	
HD 8 86.52	03/2007 -	B 180 APC	B 180 EHD	B 185 APC	
HD 8 86.54	01/2005 -	B 180 APC	B 180 EHD	B 185 APC	
HD 8 86.56	03/2007 -	B 180 APC	B 180 EHD	B 185 APC	
HD 8 88.45	01/2005 -	B 180 APC	B 180 EHD	B 185 APC	
HD 8 88.48	03/2007 -	B 180 APC	B 180 EHD	B 185 APC	
HD 8 88.50	01/2005 -	B 180 APC	B 180 EHD	B 185 APC	
HD 8 88.52	03/2007 -	B 180 APC	B 180 EHD	B 185 APC	
HD 8 88.54	01/2005 -	B 180 APC	B 180 EHD	B 185 APC	
HD 8 88.56	03/2007 -	B 180 APC	B 180 EHD	B 185 APC	
DAF					
45 FA 45.120-035	05/1991 - 12/2000				CB 110 RST
45 FA 45.120-06	05/1991 - 12/2000				CB 110 RST
45 FA 45.130 B06,FA 45.130 C06	05/1991 - 12/2000				CB 110 RST
45 FA 45.130 B08,FA 45.130 C08	05/1991 - 12/2000				CB 110 RST
45 FA 45.150 B08,FA 45.150 C08	05/1991 - 12/2000				CB 110 RST
45 FA 45.150 B11,FA 45.150 C11	05/1991 - 12/2000				CB 110 RST
45 FA 45.150 C09	05/1991 - 12/2000				CB 110 RST
45 FA 45.150-10,FA 45.150 B10	05/1991 - 12/2000				CB 110 RST
45 FA 45.160 -10	05/1991 - 12/2000				CB 110 RST
45 FA 45.160 C08	05/1991 - 12/2000				CB 110 RST
45 FA 45.160 C09	05/1991 - 12/2000				CB 110 RST
45 FA 45.160 C11	05/1991 - 12/2000				CB 110 RST
45 FA 45.180 B08	05/1995 - 12/2000				CB 110 RST
45 FA 45.180 B10	05/1995 - 12/2000				CB 110 RST
45 FA 45.180 B11	05/1995 - 12/2000				CB 110 RST
45 FA 45.210 B11	05/1995 - 12/2000				CB 110 RST
55 FA 55.150 B13	11/1995 - 12/2000				CH 125 RST
55 FA 55.180 B13	11/1995 - 12/2000				CH 125 RST

MARCHIO E MODELLO - MAKE AND MODEL MARQUE ET MODÈLE - MARKE UND MODELL MARCA Y MODELO - МАРКА И МОДЕЛЬ	Periodo Period	powerCUBE		energyCUBE	
		APC	EHD	APC	RST
DAF					
cont.					
55 FA 55.180 B15	11/1995 - 12/2000				CH 125 RST
55 FA 55.210 B13	11/1995 - 12/2000				CH 125 RST
55 FA 55.210 B15	11/1995 - 12/2000				CH 125 RST
55 FA 55.230 B13	11/1995 - 12/2000				CH 125 RST
55 FA 55.230 B15	11/1995 - 12/2000				CH 125 RST
55 FAG 55.210 B 21	11/1995 - 12/2000				CH 125 RST
65 FA 65.180	03/1993 - 02/1998	A 135 APC	A 140 EHD / A 120 EHD		
65 FA 65.210	03/1993 - 02/1998	A 135 APC	A 140 EHD / A 120 EHD		
65 FA 65.240	05/1996 - 02/1998	A 135 APC	A 140 EHD / A 120 EHD		
65 FAV 65.180	03/1993 - 02/1998	A 135 APC	A 140 EHD / A 120 EHD		
65 FAV 65.210	03/1993 - 02/1998	A 135 APC	A 140 EHD / A 120 EHD		
75 FA 75.240	07/1992 - 02/1998	A 135 APC	A 140 EHD / A 120 EHD		
75 FA 75.270	07/1992 - 02/1998	A 135 APC	A 140 EHD / A 120 EHD		
75 FA 75.300	07/1992 - 02/1998	A 135 APC	A 140 EHD / A 120 EHD		
75 FAG 75.240,FAN 75.240	07/1992 - 02/1998	A 135 APC	A 140 EHD / A 120 EHD		
75 FAG 75.270,FAN 75.270	07/1992 - 02/1998	A 135 APC	A 140 EHD / A 120 EHD		
75 FAG 75.300,FAN 75.300	07/1992 - 02/1998	A 135 APC	A 140 EHD / A 120 EHD		
75 FAR 75.240,FAS 75.240	07/1992 - 02/1998	A 135 APC	A 140 EHD / A 120 EHD		
75 FAR 75.270,FAS 75.270	07/1992 - 02/1998	A 135 APC	A 140 EHD / A 120 EHD		
75 FAR 75.300,FAS 75.300	07/1992 - 02/1998	A 135 APC	A 140 EHD / A 120 EHD		
75 FAT 75.270	07/1992 - 02/1998	A 135 APC	A 140 EHD / A 120 EHD		
75 FAV 75.240	07/1992 - 02/1998	A 135 APC	A 140 EHD / A 120 EHD		
75 FAV 75.270	07/1992 - 02/1998	A 135 APC	A 140 EHD / A 120 EHD		
75 FT 75.240	07/1992 - 02/1998	A 135 APC	A 140 EHD / A 120 EHD		
75 FT 75.270	07/1992 - 02/1998	A 135 APC	A 140 EHD / A 120 EHD		
75 FT 75.300	07/1992 - 02/1998	A 135 APC	A 140 EHD / A 120 EHD		
85 FA 85.330	07/1992 - 02/1998	B 180 APC	B 180 EHD / B 160 EHD	B 185 APC	
85 FA 85.360	07/1992 - 02/1998	B 180 APC	B 180 EHD / B 160 EHD	B 185 APC	
85 FA 85.400	03/1995 - 02/1998	B 180 APC	B 180 EHD / B 160 EHD	B 185 APC	
85 FAD 85.330	07/1992 - 02/1998	B 180 APC	B 180 EHD / B 160 EHD	B 185 APC	
85 FAD 85.360	07/1992 - 02/1998	B 180 APC	B 180 EHD / B 160 EHD	B 185 APC	
85 FAD 85.400	03/1995 - 02/1998	B 180 APC	B 180 EHD / B 160 EHD	B 185 APC	
85 FAG 85.330,FAR 85.330,FAS 85.330	07/1992 - 02/1998	B 180 APC	B 180 EHD / B 160 EHD	B 185 APC	
85 FAG 85.360,FAR 85.360,FAS 85.360	07/1992 - 02/1998	B 180 APC	B 180 EHD / B 160 EHD	B 185 APC	
85 FAG 85.400,FAR 85.400,FAS 85.400	03/1995 - 02/1998	B 180 APC	B 180 EHD / B 160 EHD	B 185 APC	
85 FAT 85.330	07/1992 - 02/1998	B 180 APC	B 180 EHD / B 160 EHD	B 185 APC	
85 FAT 85.360	07/1992 - 02/1998	B 180 APC	B 180 EHD / B 160 EHD	B 185 APC	
85 FAT 85.400	03/1995 - 02/1998	B 180 APC	B 180 EHD / B 160 EHD	B 185 APC	
85 FT 85.330	07/1992 - 02/1998	B 180 APC	B 180 EHD / B 160 EHD	B 185 APC	
85 FT 85.360	07/1992 - 02/1998	B 180 APC	B 180 EHD / B 160 EHD	B 185 APC	
85 FT 85.400	03/1995 - 02/1998	B 180 APC	B 180 EHD / B 160 EHD	B 185 APC	
85 FTG 85.330	07/1992 - 02/1998	B 180 APC	B 180 EHD / B 160 EHD	B 185 APC	
85 FTG 85.360	07/1992 - 02/1998	B 180 APC	B 180 EHD / B 160 EHD	B 185 APC	
85 FTG 85.400	03/1995 - 02/1998	B 180 APC	B 180 EHD / B 160 EHD	B 185 APC	
85 FTT 85.330	07/1992 - 02/1998	B 180 APC	B 180 EHD / B 160 EHD	B 185 APC	

MARCHIO E MODELLO - MAKE AND MODEL MARQUE ET MODÈLE - MARKE UND MODELL MARCA Y MODELO - МАРКА И МОДЕЛЬ	Periodo Period	powerCUBE		energyCUBE	
		APC	EHD	APC	RST
DAF <small>cont.</small>					
85 FTT 85.360	07/1992 - 02/1998	B 180 APC	B 180 EHD / B 160 EHD	B 185 APC	
85 FTT 85.400	03/1995 - 02/1998	B 180 APC	B 180 EHD / B 160 EHD	B 185 APC	
95 FA 95.310	09/1987 - 09/1990	B 180 APC	B 180 EHD / B 160 EHD	B 185 APC	
95 FA 95.330	08/1990 - 01/1993	B 180 APC	B 180 EHD / B 160 EHD	B 185 APC	
95 FA 95.350	09/1987 - 09/1990	B 180 APC	B 180 EHD / B 160 EHD	B 185 APC	
95 FA 95.360	08/1990 - 01/1998	B 180 APC	B 180 EHD / B 160 EHD	B 185 APC	
95 FA 95.380	09/1987 - 09/1990	B 180 APC	B 180 EHD / B 160 EHD	B 185 APC	
95 FA 95.400	08/1990 - 01/1998	B 180 APC	B 180 EHD / B 160 EHD	B 185 APC	
95 FA 95.430	02/1992 - 01/1998	B 180 APC	B 180 EHD / B 160 EHD	B 185 APC	
95 FAC 95.310	09/1987 -	B 180 APC	B 180 EHD	B 185 APC	
95 FAC 95.330	08/1990 -	B 180 APC	B 180 EHD	B 185 APC	
95 FAC 95.350	09/1987 -	B 180 APC	B 180 EHD	B 185 APC	
95 FAC 95.360	08/1990 -	B 180 APC	B 180 EHD	B 185 APC	
95 FAC 95.380	09/1987 -	B 180 APC	B 180 EHD	B 185 APC	
95 FAC 95.400	08/1990 -	B 180 APC	B 180 EHD	B 185 APC	
95 FAC 95.430	02/1992 -	B 180 APC	B 180 EHD	B 185 APC	
95 FAD 95.310	09/1987 -	B 180 APC	B 180 EHD	B 185 APC	
95 FAD 95.330	08/1990 -	B 180 APC	B 180 EHD	B 185 APC	
95 FAD 95.350	09/1987 - 09/1990	B 180 APC	B 180 EHD / B 160 EHD	B 185 APC	
95 FAD 95.360	08/1990 - 01/1998	B 180 APC	B 180 EHD / B 160 EHD	B 185 APC	
95 FAD 95.380	09/1987 - 09/1990	B 180 APC	B 180 EHD / B 160 EHD	B 185 APC	
95 FAD 95.400	08/1990 - 01/1998	B 180 APC	B 180 EHD / B 160 EHD	B 185 APC	
95 FAD 95.430	02/1992 - 01/1998	B 180 APC	B 180 EHD / B 160 EHD	B 185 APC	
95 FAG 95.350,FAR 95.350,FAS 95.350	09/1987 - 09/1990	B 180 APC	B 180 EHD / B 160 EHD	B 185 APC	
95 FAG 95.360,FAR 95.360,FAS 95.360	08/1990 - 01/1998	B 180 APC	B 180 EHD / B 160 EHD	B 185 APC	
95 FAG 95.380,FAR 95.380,FAS 95.380	09/1987 - 09/1990	B 180 APC	B 180 EHD / B 160 EHD	B 185 APC	
95 FAG 95.400,FAR 95.400,FAS 95.400	08/1990 - 01/1998	B 180 APC	B 180 EHD / B 160 EHD	B 185 APC	
95 FAG 95.430,FAR 95.430,FAS 95.430	02/1992 - 01/1998	B 180 APC	B 180 EHD / B 160 EHD	B 185 APC	
95 FAK 95.360	08/1990 - 01/1998	B 180 APC	B 180 EHD / B 160 EHD	B 185 APC	
95 FAK 95.400	08/1990 - 01/1998	B 180 APC	B 180 EHD / B 160 EHD	B 185 APC	
95 FAK 95.430	02/1992 - 01/1998	B 180 APC	B 180 EHD / B 160 EHD	B 185 APC	
95 FAR 95.310	09/1987 - 09/1990	B 180 APC	B 180 EHD / B 160 EHD	B 185 APC	
95 FAR 95.330,FAS 95.330	08/1990 - 01/1993	B 180 APC	B 180 EHD / B 160 EHD	B 185 APC	
95 FAT 95.350	09/1987 - 09/1990	B 180 APC	B 180 EHD / B 160 EHD	B 185 APC	
95 FAT 95.360	08/1990 - 01/1998	B 180 APC	B 180 EHD / B 160 EHD	B 185 APC	
95 FAT 95.380	09/1987 - 09/1990	B 180 APC	B 180 EHD / B 160 EHD	B 185 APC	
95 FAT 95.400	08/1990 - 01/1998	B 180 APC	B 180 EHD / B 160 EHD	B 185 APC	
95 FAT 95.430	02/1992 - 01/1998	B 180 APC	B 180 EHD / B 160 EHD	B 185 APC	
95 FT 95.310	09/1987 - 09/1990	B 180 APC	B 180 EHD / B 160 EHD	B 185 APC	
95 FT 95.330	08/1990 - 01/1993	B 180 APC	B 180 EHD / B 160 EHD	B 185 APC	
95 FT 95.350	09/1987 - 09/1990	B 180 APC	B 180 EHD / B 160 EHD	B 185 APC	
95 FT 95.360	08/1990 - 01/1998	B 180 APC	B 180 EHD / B 160 EHD	B 185 APC	
95 FT 95.380	09/1987 - 09/1990	B 180 APC	B 180 EHD / B 160 EHD	B 185 APC	
95 FT 95.400	08/1990 - 01/1998	B 180 APC	B 180 EHD / B 160 EHD	B 185 APC	
95 FT 95.430	02/1992 - 01/1998	B 180 APC	B 180 EHD / B 160 EHD	B 185 APC	

MARCHIO E MODELLO - MAKE AND MODEL MARQUE ET MODÈLE - MARKE UND MODELL MARCA Y MODELO - МАРКА И МОДЕЛЬ	Periodo Period	powerCUBE		energyCUBE	
		APC	EHD	APC	RST
DAF	cont.				
95 FT 95.500	02/1994 - 01/1998	B 180 APC	B 180 EHD / B 160 EHD	B 185 APC	
95 FTG 95.310	09/1987 -	B 180 APC	B 180 EHD	B 185 APC	
95 FTG 95.330	08/1990 -	B 180 APC	B 180 EHD	B 185 APC	
95 FTG 95.350,FTS 95.350	09/1987 - 09/1990	B 180 APC	B 180 EHD / B 160 EHD	B 185 APC	
95 FTG 95.360,FTR 95.360,FTS 95.360	08/1990 - 01/1998	B 180 APC	B 180 EHD / B 160 EHD	B 185 APC	
95 FTG 95.380,FTS 95.380	09/1987 - 09/1990	B 180 APC	B 180 EHD / B 160 EHD	B 185 APC	
95 FTG 95.400,FTR 95.400,FTS 95.400	08/1990 - 01/1998	B 180 APC	B 180 EHD / B 160 EHD	B 185 APC	
95 FTG 95.430,FTR 95.430,FTS 95.430	02/1992 - 01/1998	B 180 APC	B 180 EHD / B 160 EHD	B 185 APC	
95 FTT 95.310	09/1987 -	B 180 APC	B 180 EHD	B 185 APC	
95 FTT 95.330	09/1987 -	B 180 APC	B 180 EHD	B 185 APC	
95 FTT 95.350	09/1987 - 09/1990	B 180 APC	B 180 EHD / B 160 EHD	B 185 APC	
95 FTT 95.360	08/1990 - 01/1998	B 180 APC	B 180 EHD / B 160 EHD	B 185 APC	
95 FTT 95.380	09/1987 - 09/1990	B 180 APC	B 180 EHD / B 160 EHD	B 185 APC	
95 FTT 95.400	08/1990 - 01/1998	B 180 APC	B 180 EHD / B 160 EHD	B 185 APC	
95 FTT 95.430	02/1992 - 01/1998	B 180 APC	B 180 EHD / B 160 EHD	B 185 APC	
65 CF FA 65 CF 180	02/1998 - 12/2000	A 135 APC	A 140 EHD		
65 CF FA 65 CF 210	02/1998 - 12/2000	A 135 APC	A 140 EHD		
65 CF FA 65 CF 240	02/1998 - 12/2000	A 135 APC	A 140 EHD		
65 CF FAV 65 CF 180	02/1998 - 12/2000	A 135 APC	A 140 EHD		
65 CF FAV 65 CF 210	02/1998 - 12/2000	A 135 APC	A 140 EHD		
75 CF FA 75 CF 250	02/1998 - 12/2000	A 135 APC	A 140 EHD		
75 CF FA 75 CF 290	02/1998 - 12/2000	A 135 APC	A 140 EHD		
75 CF FA 75 CF 320	02/1998 - 12/2000	A 135 APC	A 140 EHD		
75 CF FAG 75 CF 250,FAN 75 CF 250	02/1998 - 12/2000	A 135 APC	A 140 EHD		
75 CF FAG 75 CF 290,FAN 75 CF 290	02/1998 - 12/2000	A 135 APC	A 140 EHD		
75 CF FAG 75 CF 320,FAN 75 CF 320	02/1998 - 12/2000	A 135 APC	A 140 EHD		
75 CF FAR 75 CF 250,FAS 75 CF 250	02/1998 - 12/2000	A 135 APC	A 140 EHD		
75 CF FAR 75 CF 290,FAS 75 CF 290	02/1998 - 12/2000	A 135 APC	A 140 EHD		
75 CF FAR 75 CF 320,FAS 75 CF 320	02/1998 - 12/2000	A 135 APC	A 140 EHD		
75 CF FAT 75 CF 250	02/1998 - 12/2000	A 135 APC	A 140 EHD		
75 CF FAT 75 CF 290	02/1998 - 12/2000	A 135 APC	A 140 EHD		
75 CF FAT 75 CF 320	02/1998 - 12/2000	A 135 APC	A 140 EHD		
75 CF FT 75 CF 250	02/1998 - 12/2000	A 135 APC	A 140 EHD		
75 CF FT 75 CF 290	02/1998 - 12/2000	A 135 APC	A 140 EHD		
75 CF FT 75 CF 320	02/1998 - 12/2000	A 135 APC	A 140 EHD		
85 CF FA 85 CF 340	02/1998 - 12/2000	B 180 APC	B 180 EHD / B 160 EHD	B 185 APC	
85 CF FA 85 CF 380	02/1998 - 12/2000	B 180 APC	B 180 EHD / B 160 EHD	B 185 APC	
85 CF FA 85 CF 430	02/1998 - 12/2000	B 180 APC	B 180 EHD / B 160 EHD	B 185 APC	
85 CF FAC 85 CF 340	02/1998 - 12/2000	B 180 APC	B 180 EHD / B 160 EHD	B 185 APC	
85 CF FAC 85 CF 380	02/1998 - 12/2000	B 180 APC	B 180 EHD / B 160 EHD	B 185 APC	
85 CF FAC 85 CF 430	02/1998 - 12/2000	B 180 APC	B 180 EHD / B 160 EHD	B 185 APC	
85 CF FAD 85 CF 340	02/1998 - 12/2000	B 180 APC	B 180 EHD / B 160 EHD	B 185 APC	
85 CF FAD 85 CF 380	02/1998 - 12/2000	B 180 APC	B 180 EHD / B 160 EHD	B 185 APC	
85 CF FAD 85 CF 430	02/1998 - 12/2000	B 180 APC	B 180 EHD / B 160 EHD	B 185 APC	
85 CF FAG 85 CF 340,FAN 85 CF 340	02/1998 - 12/2000	B 180 APC	B 180 EHD / B 160 EHD	B 185 APC	

MARCHIO E MODELLO - MAKE AND MODEL MARQUE ET MODÈLE - MARKE UND MODELL MARCA Y MODELO - МАРКА И МОДЕЛЬ	Periodo Period	powerCUBE		energyCUBE	
		APC	EHD	APC	RST
DAF					
<i>cont.</i>					
85 CF FAG 85 CF 380,FAN 85 CF 380	02/1998 - 12/2000	B 180 APC	B 180 EHD / B 160 EHD	B 185 APC	
85 CF FAG 85 CF 430,FAN 85 CF 430	02/1998 - 12/2000	B 180 APC	B 180 EHD / B 160 EHD	B 185 APC	
85 CF FAR 85 CF 340	02/1998 - 12/2000	B 180 APC	B 180 EHD / B 160 EHD	B 185 APC	
85 CF FAR 85 CF 380	02/1998 - 12/2000	B 180 APC	B 180 EHD / B 160 EHD	B 185 APC	
85 CF FAR 85 CF 430	02/1998 - 12/2000	B 180 APC	B 180 EHD / B 160 EHD	B 185 APC	
85 CF FAS 85 CF 340	02/1998 - 12/2000	B 180 APC	B 180 EHD / B 160 EHD	B 185 APC	
85 CF FAS 85 CF 380	02/1998 - 12/2000	B 180 APC	B 180 EHD / B 160 EHD	B 185 APC	
85 CF FAS 85 CF 430	02/1998 - 12/2000	B 180 APC	B 180 EHD / B 160 EHD	B 185 APC	
85 CF FAT 85 CF 340	02/1998 - 12/2000	B 180 APC	B 180 EHD / B 160 EHD	B 185 APC	
85 CF FAT 85 CF 380	02/1998 - 12/2000	B 180 APC	B 180 EHD / B 160 EHD	B 185 APC	
85 CF FAT 85 CF 430	02/1998 - 12/2000	B 180 APC	B 180 EHD / B 160 EHD	B 185 APC	
85 CF FT 85 CF 340	02/1998 - 12/2000	B 180 APC	B 180 EHD / B 160 EHD	B 185 APC	
85 CF FT 85 CF 380	02/1998 - 12/2000	B 180 APC	B 180 EHD / B 160 EHD	B 185 APC	
85 CF FT 85 CF 430	02/1998 - 12/2000	B 180 APC	B 180 EHD / B 160 EHD	B 185 APC	
85 CF FTG 85 CF 340	02/1998 - 12/2000	B 180 APC	B 180 EHD / B 160 EHD	B 185 APC	
85 CF FTG 85 CF 380	02/1998 - 12/2000	B 180 APC	B 180 EHD / B 160 EHD	B 185 APC	
85 CF FTG 85 CF 430	02/1998 - 12/2000	B 180 APC	B 180 EHD / B 160 EHD	B 185 APC	
85 CF FTT 85 CF 340	02/1998 - 12/2000	B 180 APC	B 180 EHD / B 160 EHD	B 185 APC	
85 CF FTT 85 CF 380	02/1998 - 12/2000	B 180 APC	B 180 EHD / B 160 EHD	B 185 APC	
85 CF FTT 85 CF 430	02/1998 - 12/2000	B 180 APC	B 180 EHD / B 160 EHD	B 185 APC	
85 CF FTT 85.360	10/2006 -	B 180 APC	B 180 EHD / B 160 EHD	B 185 APC	
95 XF FA 95 XF 380	01/1997 - 09/2002	B 180 APC	B 180 EHD / B 160 EHD	B 185 APC	
95 XF FA 95 XF 430	01/1997 - 09/2002	B 180 APC	B 180 EHD / B 160 EHD	B 185 APC	
95 XF FA 95 XF 480	01/1997 - 09/2002	B 180 APC	B 180 EHD / B 160 EHD	B 185 APC	
95 XF FA 95 XF 530	01/1997 - 09/2002	B 180 APC	B 180 EHD / B 160 EHD	B 185 APC	
95 XF FA 95 XF 530	02/2001 - 09/2002	B 180 APC	B 180 EHD / B 160 EHD	B 185 APC	
95 XF FAC 95 XF 380	01/1997 - 09/2002	B 180 APC	B 180 EHD / B 160 EHD	B 185 APC	
95 XF FAC 95 XF 430	01/1997 - 09/2002	B 180 APC	B 180 EHD / B 160 EHD	B 185 APC	
95 XF FAC 95 XF 480	01/1997 - 09/2002	B 180 APC	B 180 EHD / B 160 EHD	B 185 APC	
95 XF FAC 95 XF 530	01/1997 - 09/2002	B 180 APC	B 180 EHD / B 160 EHD	B 185 APC	
95 XF FAD 95 XF 380	01/1997 - 09/2002	B 180 APC	B 180 EHD / B 160 EHD	B 185 APC	
95 XF FAD 95 XF 430	01/1997 - 09/2002	B 180 APC	B 180 EHD / B 160 EHD	B 185 APC	
95 XF FAD 95 XF 480	01/1997 - 09/2002	B 180 APC	B 180 EHD / B 160 EHD	B 185 APC	
95 XF FAD 95 XF 530	01/1997 - 09/2002	B 180 APC	B 180 EHD / B 160 EHD	B 185 APC	
95 XF FAR 95 XF 380	01/1997 - 09/2002	B 180 APC	B 180 EHD / B 160 EHD	B 185 APC	
95 XF FAR 95 XF 430	01/1997 - 09/2002	B 180 APC	B 180 EHD / B 160 EHD	B 185 APC	
95 XF FAR 95 XF 480	01/1997 - 09/2002	B 180 APC	B 180 EHD / B 160 EHD	B 185 APC	
95 XF FAR 95 XF 530	01/1997 - 09/2002	B 180 APC	B 180 EHD / B 160 EHD	B 185 APC	
95 XF FAS 95 XF 380	01/1997 - 09/2002	B 180 APC	B 180 EHD / B 160 EHD	B 185 APC	
95 XF FAS 95 XF 430	01/1997 - 09/2002	B 180 APC	B 180 EHD / B 160 EHD	B 185 APC	
95 XF FAS 95 XF 480	01/1997 - 09/2002	B 180 APC	B 180 EHD / B 160 EHD	B 185 APC	
95 XF FAS 95 XF 530	01/1997 - 09/2002	B 180 APC	B 180 EHD / B 160 EHD	B 185 APC	
95 XF FAT 95 XF 380	01/1997 - 09/2002	B 180 APC	B 180 EHD / B 160 EHD	B 185 APC	
95 XF FAT 95 XF 430	01/1997 - 09/2002	B 180 APC	B 180 EHD / B 160 EHD	B 185 APC	
95 XF FAT 95 XF 480	01/1997 - 09/2002	B 180 APC	B 180 EHD / B 160 EHD	B 185 APC	

MARCHIO E MODELLO - MAKE AND MODEL MARQUE ET MODÈLE - MARKE UND MODELL MARCA Y MODELO - МАРКА И МОДЕЛЬ	Periodo Period	powerCUBE		energyCUBE	
		APC	EHD	APC	RST
DAF <small>cont.</small>					
95 XF FAT 95 XF 530	01/1997 - 09/2002	B 180 APC	B 180 EHD / B 160 EHD	B 185 APC	
95 XF FT 95 XF 380	01/1997 - 09/2002	B 180 APC	B 180 EHD / B 160 EHD	B 185 APC	
95 XF FT 95 XF 430	01/1997 - 09/2002	B 180 APC	B 180 EHD / B 160 EHD	B 185 APC	
95 XF FT 95 XF 480	01/1997 - 09/2002	B 180 APC	B 180 EHD / B 160 EHD	B 185 APC	
95 XF FT 95 XF 530	01/1997 - 09/2002	B 180 APC	B 180 EHD / B 160 EHD	B 185 APC	
95 XF FTG 95 XF 380	01/1997 - 09/2002	B 180 APC	B 180 EHD / B 160 EHD	B 185 APC	
95 XF FTG 95 XF 430	01/1997 - 09/2002	B 180 APC	B 180 EHD / B 160 EHD	B 185 APC	
95 XF FTG 95 XF 480	01/1997 - 09/2002	B 180 APC	B 180 EHD / B 160 EHD	B 185 APC	
95 XF FTG 95 XF 530	01/1997 - 09/2002	B 180 APC	B 180 EHD / B 160 EHD	B 185 APC	
95 XF FTG 95 XF 530	01/1997 -	B 180 APC	B 180 EHD / B 160 EHD	B 185 APC	
95 XF FTP 95.430	01/1997 - 09/2002	B 180 APC	B 180 EHD / B 160 EHD	B 185 APC	
95 XF FTR 95 XF 380	01/1997 - 09/2002	B 180 APC	B 180 EHD / B 160 EHD	B 185 APC	
95 XF FTR 95 XF 430	01/1997 - 09/2002	B 180 APC	B 180 EHD / B 160 EHD	B 185 APC	
95 XF FTR 95 XF 480	01/1997 - 09/2002	B 180 APC	B 180 EHD / B 160 EHD	B 185 APC	
95 XF FTR 95 XF 530	01/1997 - 09/2002	B 180 APC	B 180 EHD / B 160 EHD	B 185 APC	
95 XF FTS 95 XF 380	01/1997 - 09/2002	B 180 APC	B 180 EHD / B 160 EHD	B 185 APC	
95 XF FTS 95 XF 430	01/1997 - 09/2002	B 180 APC	B 180 EHD / B 160 EHD	B 185 APC	
95 XF FTS 95 XF 480	01/1997 - 09/2002	B 180 APC	B 180 EHD / B 160 EHD	B 185 APC	
95 XF FTS 95 XF 530	01/1997 - 09/2002	B 180 APC	B 180 EHD / B 160 EHD	B 185 APC	
95 XF FTT 95 XF 380	01/1997 - 09/2002	B 180 APC	B 180 EHD / B 160 EHD	B 185 APC	
95 XF FTT 95 XF 430	01/1997 - 09/2002	B 180 APC	B 180 EHD / B 160 EHD	B 185 APC	
95 XF FTT 95 XF 480	01/1997 - 09/2002	B 180 APC	B 180 EHD / B 160 EHD	B 185 APC	
95 XF FTT 95 XF 530	01/1997 - 09/2002	B 180 APC	B 180 EHD / B 160 EHD	B 185 APC	
CF FA 290	05/2013 -	B 180 APC	B 180 EHD	B 185 APC	
CF FA 330	05/2013 -	B 180 APC	B 180 EHD	B 185 APC	
CF FA 370	05/2013 -	B 180 APC	B 180 EHD	B 185 APC	
CF FA 400	05/2013 -	B 180 APC	B 180 EHD	B 185 APC	
CF FA 410	05/2013 -	B 180 APC	B 180 EHD	B 185 APC	
CF FA 440	05/2013 -	B 180 APC	B 180 EHD	B 185 APC	
CF FA 460	05/2013 -	B 180 APC	B 180 EHD	B 185 APC	
CF FA 510	05/2013 -	B 180 APC	B 180 EHD	B 185 APC	
CF FAD 400	05/2013 -	B 180 APC	B 180 EHD	B 185 APC	
CF FAD 410	05/2013 -	B 180 APC	B 180 EHD	B 185 APC	
CF FAD 440	05/2013 -	B 180 APC	B 180 EHD	B 185 APC	
CF FAD 460	05/2013 -	B 180 APC	B 180 EHD	B 185 APC	
CF FAD 510	05/2013 -	B 180 APC	B 180 EHD	B 185 APC	
CF FAN 290, FAG 290	05/2013 -	B 180 APC	B 180 EHD	B 185 APC	
CF FAN 330, FAG 330	05/2013 -	B 180 APC	B 180 EHD	B 185 APC	
CF FAN 370, FAG 370	05/2013 -	B 180 APC	B 180 EHD	B 185 APC	
CF FAN 400, FAG 400	05/2013 -	B 180 APC	B 180 EHD	B 185 APC	
CF FAN 410, FAG 410	05/2013 -	B 180 APC	B 180 EHD	B 185 APC	
CF FAN 440, FAG 440	05/2013 -	B 180 APC	B 180 EHD	B 185 APC	
CF FAN 460, FAG 460	05/2013 -	B 180 APC	B 180 EHD	B 185 APC	
CF FAN 510, FAG 510	05/2013 -	B 180 APC	B 180 EHD	B 185 APC	
CF FAR 290, FAS 290	05/2013 -	B 180 APC	B 180 EHD	B 185 APC	

MARCHIO E MODELLO - MAKE AND MODEL MARQUE ET MODÈLE - MARKE UND MODELL MARCA Y MODELO - МАРКА И МОДЕЛЬ	Periodo Period	powerCUBE		energyCUBE	
		APC	EHD	APC	RST
DAF					
cont.					
CF FAR 330, FAS 330	05/2013 -	B 180 APC	B 180 EHD	B 185 APC	
CF FAR 370, FAS 370	05/2013 -	B 180 APC	B 180 EHD	B 185 APC	
CF FAR 400, FAS 400	05/2013 -	B 180 APC	B 180 EHD	B 185 APC	
CF FAR 410, FAS 410	05/2013 -	B 180 APC	B 180 EHD	B 185 APC	
CF FAR 440, FAS 440	05/2013 -	B 180 APC	B 180 EHD	B 185 APC	
CF FAR 460, FAS 460	05/2013 -	B 180 APC	B 180 EHD	B 185 APC	
CF FAR 510, FAS 510	05/2013 -	B 180 APC	B 180 EHD	B 185 APC	
CF FAT 290	05/2013 -	B 180 APC	B 180 EHD	B 185 APC	
CF FAT 330	05/2013 -	B 180 APC	B 180 EHD	B 185 APC	
CF FAT 370	05/2013 -	B 180 APC	B 180 EHD	B 185 APC	
CF FAT 400	05/2013 -	B 180 APC	B 180 EHD	B 185 APC	
CF FAT 410	05/2013 -	B 180 APC	B 180 EHD	B 185 APC	
CF FAT 440	05/2013 -	B 180 APC	B 180 EHD	B 185 APC	
CF FAT 460	05/2013 -	B 180 APC	B 180 EHD	B 185 APC	
CF FAT 510	05/2013 -	B 180 APC	B 180 EHD	B 185 APC	
CF FT 290	05/2013 -	B 180 APC	B 180 EHD	B 185 APC	
CF FT 330	05/2013 -	B 180 APC	B 180 EHD	B 185 APC	
CF FT 370	05/2013 -	B 180 APC	B 180 EHD	B 185 APC	
CF FT 400	05/2013 -	B 180 APC	B 180 EHD	B 185 APC	
CF FT 410	05/2013 -	B 180 APC	B 180 EHD	B 185 APC	
CF FT 440	05/2013 -	B 180 APC	B 180 EHD	B 185 APC	
CF FT 460	05/2013 -	B 180 APC	B 180 EHD	B 185 APC	
CF FT 510	05/2013 -	B 180 APC	B 180 EHD	B 185 APC	
CF FTG 400	05/2013 -	B 180 APC	B 180 EHD	B 185 APC	
CF FTG 410	05/2013 -	B 180 APC	B 180 EHD	B 185 APC	
CF FTG 440	05/2013 -	B 180 APC	B 180 EHD	B 185 APC	
CF FTG 460	05/2013 -	B 180 APC	B 180 EHD	B 185 APC	
CF FTG 510	05/2013 -	B 180 APC	B 180 EHD	B 185 APC	
CF FTP 400	05/2013 -	B 180 APC	B 180 EHD	B 185 APC	
CF FTP 440	05/2013 -	B 180 APC	B 180 EHD	B 185 APC	
CF FTS 410	05/2013 -	B 180 APC	B 180 EHD	B 185 APC	
CF FTS 460	05/2013 -	B 180 APC	B 180 EHD	B 185 APC	
CF FTS 510	05/2013 -	B 180 APC	B 180 EHD	B 185 APC	
CF FTT 400	05/2013 -	B 180 APC	B 180 EHD	B 185 APC	
CF FTT 410	05/2013 -	B 180 APC	B 180 EHD	B 185 APC	
CF FTT 440	05/2013 -	B 180 APC	B 180 EHD	B 185 APC	
CF FTT 460	05/2013 -	B 180 APC	B 180 EHD	B 185 APC	
CF FTT 510	05/2013 -	B 180 APC	B 180 EHD	B 185 APC	
CF 65 FA 65.180	01/2001 -	B 180 APC	B 180 EHD / B 160 EHD	B 185 APC	
CF 65 FA 65.220	01/2001 -	B 180 APC	B 180 EHD / B 160 EHD	B 185 APC	
CF 65 FA 65.220	05/2006 -	B 180 APC	B 180 EHD / B 160 EHD	B 185 APC	
CF 65 FA 65.250	01/2001 -	B 180 APC	B 180 EHD / B 160 EHD	B 185 APC	
CF 65 FA 65.250	05/2006 -	B 180 APC	B 180 EHD / B 160 EHD	B 185 APC	
CF 65 FA 65.290	05/2006 -	B 180 APC	B 180 EHD / B 160 EHD	B 185 APC	
CF 65 FA 65.300	01/2009 -	B 180 APC		B 185 APC	

MARCHIO E MODELLO - MAKE AND MODEL MARQUE ET MODÈLE - MARKE UND MODELL MARCA Y MODELO - МАРКА И МОДЕЛЬ	Periodo Period	powerCUBE		energyCUBE	
		APC	EHD	APC	RST
DAF <i>cont.</i>					
CF 75 FA 75.250	01/2001 -	B 180 APC	B 180 EHD / B 160 EHD	B 185 APC	
CF 75 FA 75.310	01/2001 -	B 180 APC	B 180 EHD / B 160 EHD	B 185 APC	
CF 75 FA 75.360	01/2001 -	B 180 APC	B 180 EHD / B 160 EHD	B 185 APC	
CF 75 FAD 75.250	01/2001 -	B 180 APC	B 180 EHD / B 160 EHD	B 185 APC	
CF 75 FAD 75.310	01/2001 -	B 180 APC	B 180 EHD / B 160 EHD	B 185 APC	
CF 75 FAD 75.360	01/2001 -	B 180 APC	B 180 EHD / B 160 EHD	B 185 APC	
CF 75 FAG 75.250, FAN 75.250	01/2001 -	B 180 APC	B 180 EHD / B 160 EHD	B 185 APC	
CF 75 FAG 75.310, FAN 75.310	01/2001 -	B 180 APC	B 180 EHD / B 160 EHD	B 185 APC	
CF 75 FAG 75.360	01/2001 -	B 180 APC	B 180 EHD / B 160 EHD	B 185 APC	
CF 75 FAR 75.250	01/2001 -	B 180 APC	B 180 EHD / B 160 EHD	B 185 APC	
CF 75 FAR 75.310, FAS 75.310	01/2001 -	B 180 APC	B 180 EHD / B 160 EHD	B 185 APC	
CF 75 FAR 75.360, FAS 75.360	01/2001 -	B 180 APC	B 180 EHD / B 160 EHD	B 185 APC	
CF 75 FAT 75.250	01/2001 -	B 180 APC	B 180 EHD / B 160 EHD	B 185 APC	
CF 75 FAT 75.310	01/2001 -	B 180 APC	B 180 EHD / B 160 EHD	B 185 APC	
CF 75 FAT 75.360	01/2001 -	B 180 APC	B 180 EHD / B 160 EHD	B 185 APC	
CF 75 FT 75.250	01/2001 -	B 180 APC	B 180 EHD / B 160 EHD	B 185 APC	
CF 75 FT 75.310	01/2001 -	B 180 APC	B 180 EHD / B 160 EHD	B 185 APC	
CF 75 FT 75.360	01/2001 -	B 180 APC	B 180 EHD / B 160 EHD	B 185 APC	
CF 85 FA 85.340	01/2001 -	B 180 APC	B 180 EHD / B 160 EHD	B 185 APC	
CF 85 FA 85.360	10/2006 -	B 180 APC	B 180 EHD / B 160 EHD	B 185 APC	
CF 85 FA 85.380	01/2001 -	B 180 APC	B 180 EHD / B 160 EHD	B 185 APC	
CF 85 FA 85.410	10/2005 -	B 180 APC	B 180 EHD / B 160 EHD	B 185 APC	
CF 85 FA 85.430	01/2001 -	B 180 APC	B 180 EHD / B 160 EHD	B 185 APC	
CF 85 FA 85.460	10/2005 -	B 180 APC	B 180 EHD / B 160 EHD	B 185 APC	
CF 85 FA 85.480	01/2001 -	B 180 APC	B 180 EHD / B 160 EHD	B 185 APC	
CF 85 FA 85.510	10/2005 -	B 180 APC	B 180 EHD / B 160 EHD	B 185 APC	
CF 85 FAC 85.340	12/2005 -	B 180 APC	B 180 EHD / B 160 EHD	B 185 APC	
CF 85 FAC 85.360, FAX 85.360	10/2006 -	B 180 APC	B 180 EHD / B 160 EHD	B 185 APC	
CF 85 FAC 85.380	12/2005 -	B 180 APC	B 180 EHD / B 160 EHD	B 185 APC	
CF 85 FAC 85.410, FAX 85.410	10/2005 -	B 180 APC	B 180 EHD / B 160 EHD	B 185 APC	
CF 85 FAC 85.430	12/2005 -	B 180 APC	B 180 EHD / B 160 EHD	B 185 APC	
CF 85 FAC 85.460, FAX 85.460	10/2005 -	B 180 APC	B 180 EHD / B 160 EHD	B 185 APC	
CF 85 FAC 85.480	12/2005 -	B 180 APC	B 180 EHD / B 160 EHD	B 185 APC	
CF 85 FAC 85.510, FAX 85.510	10/2005 -	B 180 APC	B 180 EHD / B 160 EHD	B 185 APC	
CF 85 FAD	01/2001 -	B 180 APC	B 180 EHD / B 160 EHD	B 185 APC	
CF 85 FAD 85.360	10/2006 -	B 180 APC	B 180 EHD / B 160 EHD	B 185 APC	
CF 85 FAD 85.380	01/2001 -	B 180 APC	B 180 EHD / B 160 EHD	B 185 APC	
CF 85 FAD 85.410	10/2005 -	B 180 APC	B 180 EHD / B 160 EHD	B 185 APC	
CF 85 FAD 85.410	10/2006 -	B 180 APC	B 180 EHD / B 160 EHD	B 185 APC	
CF 85 FAD 85.430	01/2001 -	B 180 APC	B 180 EHD / B 160 EHD	B 185 APC	
CF 85 FAD 85.460	10/2005 -	B 180 APC	B 180 EHD / B 160 EHD	B 185 APC	
CF 85 FAD 85.480	01/2001 -	B 180 APC	B 180 EHD / B 160 EHD	B 185 APC	
CF 85 FAD 85.510	10/2005 -	B 180 APC	B 180 EHD / B 160 EHD	B 185 APC	
CF 85 FAG 85.340	01/2001 -	B 180 APC	B 180 EHD / B 160 EHD	B 185 APC	
CF 85 FAG 85.360, FAN 85.360	10/2006 -	B 180 APC	B 180 EHD / B 160 EHD	B 185 APC	

MARCHIO E MODELLO - MAKE AND MODEL MARQUE ET MODÈLE - MARKE UND MODELL MARCA Y MODELO - МАРКА И МОДЕЛЬ	Periodo Period	powerCUBE		energyCUBE	
		APC	EHD	APC	RST
DAF					
<small>cont.</small>					
CF 85 FAG 85.380, FAN 85.380	01/2001 -	B 180 APC	B 180 EHD / B 160 EHD	B 185 APC	
CF 85 FAG 85.410, FAN 85.410	10/2005 -	B 180 APC	B 180 EHD / B 160 EHD	B 185 APC	
CF 85 FAG 85.430	01/2001 -	B 180 APC	B 180 EHD / B 160 EHD	B 185 APC	
CF 85 FAG 85.460, FAN 85.460	10/2005 -	B 180 APC	B 180 EHD / B 160 EHD	B 185 APC	
CF 85 FAG 85.480, FAN 85.480	01/2001 -	B 180 APC	B 180 EHD / B 160 EHD	B 185 APC	
CF 85 FAG 85.510, FAN 85.510	10/2005 -	B 180 APC	B 180 EHD / B 160 EHD	B 185 APC	
CF 85 Far 85.340, FAS	01/2001 -	B 180 APC	B 180 EHD / B 160 EHD	B 185 APC	
CF 85 FAR 85.360, FAS 85.360	10/2006 -	B 180 APC	B 180 EHD / B 160 EHD	B 185 APC	
CF 85 FAR 85.380, FAS 85.380	01/2001 -	B 180 APC	B 180 EHD / B 160 EHD	B 185 APC	
CF 85 FAR 85.410, FAS 85.410	10/2005 -	B 180 APC	B 180 EHD / B 160 EHD	B 185 APC	
CF 85 FAR 85.430, FAS 85.430	01/2001 -	B 180 APC	B 180 EHD / B 160 EHD	B 185 APC	
CF 85 FAR 85.460, FAS 85.460	10/2005 -	B 180 APC	B 180 EHD / B 160 EHD	B 185 APC	
CF 85 FAR 85.480, FAS 85.480	01/2001 -	B 180 APC	B 180 EHD / B 160 EHD	B 185 APC	
CF 85 FAR 85.510, FAS 85.510	10/2005 -	B 180 APC	B 180 EHD / B 160 EHD	B 185 APC	
CF 85 FAT 85.340	01/2001 -	B 180 APC	B 180 EHD / B 160 EHD	B 185 APC	
CF 85 FAT 85.360		B 180 APC	B 180 EHD / B 160 EHD	B 185 APC	
CF 85 FAT 85.360	10/2006 -	B 180 APC	B 180 EHD / B 160 EHD	B 185 APC	
CF 85 FAT 85.410	10/2005 -	B 180 APC	B 180 EHD / B 160 EHD	B 185 APC	
CF 85 FAT 85.430	01/2001 -	B 180 APC	B 180 EHD / B 160 EHD	B 185 APC	
CF 85 FAT 85.460	10/2005 -	B 180 APC	B 180 EHD / B 160 EHD	B 185 APC	
CF 85 FAT 85.480	01/2001 -	B 180 APC	B 180 EHD / B 160 EHD	B 185 APC	
CF 85 FAT 85.510	10/2005 -	B 180 APC	B 180 EHD / B 160 EHD	B 185 APC	
CF 85 FAX 85.340		B 180 APC	B 180 EHD / B 160 EHD	B 185 APC	
CF 85 FAX 85.360	10/2005 -	B 180 APC	B 180 EHD / B 160 EHD	B 185 APC	
CF 85 FAX 85.380		B 180 APC	B 180 EHD / B 160 EHD	B 185 APC	
CF 85 FAX 85.430		B 180 APC	B 180 EHD / B 160 EHD	B 185 APC	
CF 85 FAX 85.480		B 180 APC	B 180 EHD / B 160 EHD	B 185 APC	
CF 85 FT 85.340	01/2001 -	B 180 APC	B 180 EHD / B 160 EHD	B 185 APC	
CF 85 FT 85.360, FTP 85.360	10/2006 -	B 180 APC	B 180 EHD / B 160 EHD	B 185 APC	
CF 85 FT 85.380	01/2001 -	B 180 APC	B 180 EHD / B 160 EHD	B 185 APC	
CF 85 FT 85.410	10/2005 -	B 180 APC	B 180 EHD / B 160 EHD	B 185 APC	
CF 85 FT 85.430	01/2001 -	B 180 APC	B 180 EHD / B 160 EHD	B 185 APC	
CF 85 FT 85.460	10/2005 -	B 180 APC	B 180 EHD / B 160 EHD	B 185 APC	
CF 85 FT 85.480	01/2001 -	B 180 APC	B 180 EHD / B 160 EHD	B 185 APC	
CF 85 FT 85.510	10/2005 -	B 180 APC	B 180 EHD / B 160 EHD	B 185 APC	
CF 85 FTG 85.340	01/2001 -	B 180 APC	B 180 EHD / B 160 EHD	B 185 APC	
CF 85 FTG 85.360	10/2006 -	B 180 APC	B 180 EHD / B 160 EHD	B 185 APC	
CF 85 FTG 85.380	01/2001 -	B 180 APC	B 180 EHD / B 160 EHD	B 185 APC	
CF 85 FTG 85.410	10/2005 -	B 180 APC	B 180 EHD / B 160 EHD	B 185 APC	
CF 85 FTG 85.430	10/2001 -	B 180 APC	B 180 EHD / B 160 EHD	B 185 APC	
CF 85 FTG 85.460	10/2005 -	B 180 APC	B 180 EHD / B 160 EHD	B 185 APC	
CF 85 FTG 85.480	01/2001 -	B 180 APC	B 180 EHD / B 160 EHD	B 185 APC	
CF 85 FTG 85.510	10/2005 -	B 180 APC	B 180 EHD / B 160 EHD	B 185 APC	
CF 85 FTP 85.340		B 180 APC	B 180 EHD / B 160 EHD	B 185 APC	
CF 85 FTP 85.380		B 180 APC	B 180 EHD / B 160 EHD	B 185 APC	

MARCHIO E MODELLO - MAKE AND MODEL MARQUE ET MODÈLE - MARKE UND MODELL MARCA Y MODELO - МАРКА И МОДЕЛЬ	Periodo Period	powerCUBE		energyCUBE	
		APC	EHD	APC	RST
DAF					
	cont.				
CF 85 FTP 85.430		B 180 APC	B 180 EHD / B 160 EHD	B 185 APC	
CF 85 FTP 85.480		B 180 APC	B 180 EHD / B 160 EHD	B 185 APC	
CF 85 FTS 85.340	01/2001 -	B 180 APC	B 180 EHD / B 160 EHD	B 185 APC	
CF 85 FTS 85.360	10/2006 -	B 180 APC	B 180 EHD / B 160 EHD	B 185 APC	
CF 85 FTS 85.380	01/2001 -	B 180 APC	B 180 EHD / B 160 EHD	B 185 APC	
CF 85 FTS 85.410	10/2005 -	B 180 APC	B 180 EHD / B 160 EHD	B 185 APC	
CF 85 FTS 85.430	01/2001 -	B 180 APC	B 180 EHD / B 160 EHD	B 185 APC	
CF 85 FTS 85.460	10/2005 -	B 180 APC	B 180 EHD / B 160 EHD	B 185 APC	
CF 85 FTS 85.480	01/2001 -	B 180 APC	B 180 EHD / B 160 EHD	B 185 APC	
CF 85 FTS 85.510, FTP 85.510	10/2005 -	B 180 APC	B 180 EHD / B 160 EHD	B 185 APC	
CF 85 FTT 85.340	01/2001 -	B 180 APC	B 180 EHD / B 160 EHD	B 185 APC	
CF 85 FTT 85.380	01/2001 -	B 180 APC	B 180 EHD / B 160 EHD	B 185 APC	
CF 85 FTT 85.410	10/2005 -	B 180 APC	B 180 EHD / B 160 EHD	B 185 APC	
CF 85 FTT 85.430	01/2001 -	B 180 APC	B 180 EHD / B 160 EHD	B 185 APC	
CF 85 FTT 85.460	10/2005 -	B 180 APC	B 180 EHD / B 160 EHD	B 185 APC	
CF 85 FTT 85.480	01/2001 -	B 180 APC	B 180 EHD / B 160 EHD	B 185 APC	
CF 85 FTT 85.510	10/2005 -	B 180 APC	B 180 EHD / B 160 EHD	B 185 APC	
DB DB 250	01/1991 -	CX 225 APC		CX 220 APC	
F 1000 FA 1000 CB	05/1987 - 12/1992				CB 110 RST
F 1000 FA 1000 CN	12/1986 - 12/1992				CB 110 RST
F 1100 FA 1100 DD	01/1978 - 12/1981	A 135 APC	A 140 EHD / A 120 EHD		
F 1100 FA 1100 DF	11/1981 - 11/1988	A 135 APC	A 140 EHD / A 120 EHD		
F 1100 FA 1100 DNTD	12/1986 - 11/1990	A 135 APC	A 140 EHD / A 120 EHD		
F 1100 FA 1100 DT	11/1983 - 11/1988	A 135 APC	A 140 EHD / A 120 EHD		
F 1200 FA 1200 DD	01/1969 - 12/1981	A 135 APC	A 140 EHD / A 120 EHD		
F 1300 FA 1300 DF	07/1978 - 10/1988	A 135 APC	A 140 EHD / A 120 EHD		
F 1300 FA 1300 DNT,FA 1300 NT	12/1986 - 12/1992	A 135 APC	A 140 EHD / A 120 EHD		
F 1300 FA 1300 DNTD,FA 1300 NB	12/1986 - 12/1992	A 135 APC	A 140 EHD / A 120 EHD		
F 1300 FA 1300 DT	07/1978 - 02/1990	A 135 APC	A 140 EHD / A 120 EHD		
F 1300 FA 1300 DT-B	07/1978 - 02/1990	A 135 APC	A 140 EHD / A 120 EHD		
F 1300 FA 1305 DT	07/1978 - 02/1990	A 135 APC	A 140 EHD / A 120 EHD		
F 1400 FA 1400 DD	02/1972 - 12/1981	A 135 APC	A 140 EHD / A 120 EHD		
F 1500 FA 1500 DF,FD 1500 DF	07/1978 - 08/1991	A 135 APC	A 140 EHD / A 120 EHD		
F 1500 FA 1500 DT,FD 1500 DT	07/1978 - 08/1991	A 135 APC	A 140 EHD / A 120 EHD		
F 1500 FT 1500 DT	07/1978 - 08/1991	A 135 APC	A 140 EHD / A 120 EHD		
F 1600 FA 1600 DF	01/1970 - 08/1991	A 135 APC	A 140 EHD / A 120 EHD		
F 1600 FA 1600 DT	01/1973 - 08/1991	A 135 APC	A 140 EHD / A 120 EHD		
F 1600 FGG 1600 DT,FGG 1621 DT	01/1973 - 08/1991	A 135 APC	A 140 EHD / A 120 EHD		
F 1600 FT 1600 DT	01/1973 - 08/1991	A 135 APC	A 140 EHD / A 120 EHD		
F 1700 FA 1700 DNS	01/1988 - 02/1995	A 135 APC	A 140 EHD / A 120 EHD		
F 1700 FA 1700 DNT,FA 1700 NT	12/1986 - 02/1995	A 135 APC	A 140 EHD / A 120 EHD		
F 1700 FA 1700 DNTD,FA 1700 NB,FD 1700 DNTD,FD 1700 NB	12/1986 - 02/1995	A 135 APC	A 140 EHD / A 120 EHD		
F 1700 FAG 1700 DNT,FAG 1700 NT	12/1986 - 02/1995	A 135 APC	A 140 EHD / A 120 EHD		
F 1700 FAG 1700 DNTD,FAG 1700 NB	12/1986 - 02/1995	A 135 APC	A 140 EHD / A 120 EHD		
F 1800 FAV 1800 DT	01/1970 - 08/1991	A 135 APC	A 140 EHD / A 120 EHD		

MARCHIO E MODELLO - MAKE AND MODEL MARQUE ET MODÈLE - MARKE UND MODELL MARCA Y MODELO - МАРКА И МОДЕЛЬ	Periodo Period	powerCUBE		energyCUBE	
		APC	EHD	APC	RST
DAF					
<i>cont.</i>					
F 1900 FA 1900 DNS	12/1986 - 09/1993	B 180 APC	B 180 EHD / B 160 EHD	B 185 APC	
F 1900 FA 1900 DNS,FA 1900 NS	12/1986 - 09/1993	B 180 APC	B 180 EHD / B 160 EHD	B 185 APC	
F 1900 FA 1900 DNT,FA 1900 NT	12/1986 - 09/1993	B 180 APC	B 180 EHD / B 160 EHD	B 185 APC	
F 1900 FA 1900 DNT,FD 1900 DNT,FD 1900 NT	12/1986 - 09/1993	B 180 APC	B 180 EHD / B 160 EHD	B 185 APC	
F 1900 FAV 1900 DNT,FAV 1900 NT	12/1986 - 09/1993	B 180 APC	B 180 EHD / B 160 EHD	B 185 APC	
F 1900 FT 1900 DNS,FT 1900 NS	12/1986 - 09/1993	B 180 APC	B 180 EHD / B 160 EHD	B 185 APC	
F 2000 FA 2000 DH	01/1970 - 12/1979	B 180 APC	B 180 EHD / B 160 EHD	B 185 APC	
F 2000 FA 2000 DHB	01/1970 - 12/1979	B 180 APC	B 180 EHD / B 160 EHD	B 185 APC	
F 2000 FAS 2000 DH	01/1970 - 12/1979	B 180 APC	B 180 EHD / B 160 EHD	B 185 APC	
F 2000 FAS 2000 DHB	01/1970 - 12/1979	B 180 APC	B 180 EHD / B 160 EHD	B 185 APC	
F 2000 FAT 2000 DH	01/1970 - 12/1979	B 180 APC	B 180 EHD / B 160 EHD	B 185 APC	
F 2000 FAT 2000 DHB	01/1970 - 12/1979	B 180 APC	B 180 EHD / B 160 EHD	B 185 APC	
F 2000 FM 2000 DH	01/1970 - 12/1979	B 180 APC	B 180 EHD / B 160 EHD	B 185 APC	
F 2000 FM 2000 DHB	01/1970 - 12/1979	B 180 APC	B 180 EHD / B 160 EHD	B 185 APC	
F 2000 FT 2000 DH	01/1970 - 12/1979	B 180 APC	B 180 EHD / B 160 EHD	B 185 APC	
F 2000 FT 2000 DHB	01/1970 - 12/1979	B 180 APC	B 180 EHD / B 160 EHD	B 185 APC	
F 2100 FA 2105 DHT	07/1981 - 09/1986	B 180 APC	B 180 EHD / B 160 EHD	B 185 APC	
F 2100 FA 2100 DF,FA 2105 DF	07/1978 - 09/1986	B 180 APC	B 180 EHD / B 160 EHD	B 185 APC	
F 2100 FA 2100 DH	07/1978 - 09/1986	B 180 APC	B 180 EHD / B 160 EHD	B 185 APC	
F 2100 FA 2105 DH	06/1986 - 08/1991	B 180 APC	B 180 EHD / B 160 EHD	B 185 APC	
F 2100 FA 2105 DHR,FA 2105 DHTD	07/1978 - 09/1986	B 180 APC	B 180 EHD / B 160 EHD	B 185 APC	
F 2100 FA 2105 DHT	06/1986 - 08/1991	B 180 APC	B 180 EHD / B 160 EHD	B 185 APC	
F 2100 FA 2105 DHTD	06/1986 - 08/1991	B 180 APC	B 180 EHD / B 160 EHD	B 185 APC	
F 2100 FAG 2100 DH,FAG 2105 DH	07/1978 - 09/1986	B 180 APC	B 180 EHD / B 160 EHD	B 185 APC	
F 2100 FAG 2100 DHR,FAG 2105 DHR,FAG 2100 DHTD	07/1978 - 09/1986	B 180 APC	B 180 EHD / B 160 EHD	B 185 APC	
F 2100 FAS 2100 DHR,FAS 2103 DHR,FAS 2105 DHR,FAS 2103 DHTD	07/1978 - 09/1986	B 180 APC	B 180 EHD / B 160 EHD	B 185 APC	
F 2100 FAS 2103 DH	07/1978 - 09/1986	B 180 APC	B 180 EHD / B 160 EHD	B 185 APC	
F 2100 FAS 2103 DH,FAS 2105 DH	06/1986 - 08/1991	B 180 APC	B 180 EHD / B 160 EHD	B 185 APC	
F 2100 FAS 2103 DHT	07/1981 - 09/1986	B 180 APC	B 180 EHD / B 160 EHD	B 185 APC	
F 2100 FAS 2103 DHTD	06/1986 - 08/1991	B 180 APC	B 180 EHD / B 160 EHD	B 185 APC	
F 2100 FT 2100 DH,FT 2105 DH	07/1978 - 08/1991	B 180 APC	B 180 EHD / B 160 EHD	B 185 APC	
F 2100 FT 2100 DHR	07/1978 - 08/1991	B 180 APC	B 180 EHD / B 160 EHD	B 185 APC	
F 2100 FT 2105 DHT	07/1981 - 09/1986	B 180 APC	B 180 EHD / B 160 EHD	B 185 APC	
F 2100 FT 2105 DHTD	06/1986 - 08/1991	B 180 APC	B 180 EHD / B 160 EHD	B 185 APC	
F 2100 FT 2105 DHTD	07/1981 - 09/1986	B 180 APC	B 180 EHD / B 160 EHD	B 185 APC	
F 2200 FA 2200 DU	01/1971 - 11/1980	B 180 APC	B 180 EHD / B 160 EHD	B 185 APC	
F 2200 FAD 2205 DU	01/1971 - 11/1980	B 180 APC	B 180 EHD / B 160 EHD	B 185 APC	
F 2200 FAS 2205 DU	01/1971 - 11/1980	B 180 APC	B 180 EHD / B 160 EHD	B 185 APC	
F 2200 FAT 2205 DU	01/1971 - 11/1980	B 180 APC	B 180 EHD / B 160 EHD	B 185 APC	
F 2200 FAZ 2205 DU	01/1971 - 11/1980	B 180 APC	B 180 EHD / B 160 EHD	B 185 APC	
F 2200 FT 2200 DU	01/1971 - 11/1980	B 180 APC	B 180 EHD / B 160 EHD	B 185 APC	
F 2300 FA 2300 DHR	07/1978 - 12/1981	B 180 APC	B 180 EHD / B 160 EHD	B 185 APC	
F 2300 FA 2300 DHU	07/1978 - 12/1981	B 180 APC	B 180 EHD / B 160 EHD	B 185 APC	
F 2300 FA 2300 HT	01/1990 - 10/1993	B 180 APC	B 180 EHD / B 160 EHD	B 185 APC	

MARCHIO E MODELLO - MAKE AND MODEL MARQUE ET MODÈLE - MARKE UND MODELL MARCA Y MODELO - МАРКА И МОДЕЛЬ	Periodo Period	powerCUBE		energyCUBE	
		APC	EHD	APC	RST
DAF <i>cont.</i>					
F 2300 FAB 2305 DHT,FAG 2305 DHT,FAS 2300 DHU,FAS 2303 DHU,FAS 2305	07/1978 - 09/1986	B 180 APC	B 180 EHD / B 160 EHD	B 185 APC	
F 2300 FAG 2300 DHT,FAG 2305 DHT	09/1986 - 08/1991	B 180 APC	B 180 EHD / B 160 EHD	B 185 APC	
F 2300 FAG 2300 DHT,FAG 2305 DHT	11/1981 - 09/1986	B 180 APC	B 180 EHD / B 160 EHD	B 185 APC	
F 2300 FAG 2300 DHTD,FAG 2305 DHTD	06/1986 - 08/1991	B 180 APC	B 180 EHD / B 160 EHD	B 185 APC	
F 2300 FAG 2300 HT,FAR 2300 HT	01/1990 - 10/1993	B 180 APC	B 180 EHD / B 160 EHD	B 185 APC	
F 2300 FAG 2305 DH	07/1978 - 12/1981	B 180 APC	B 180 EHD / B 160 EHD	B 185 APC	
F 2300 FAS 2300 DHR,FAS 2305 DHR	07/1978 - 12/1981	B 180 APC	B 180 EHD / B 160 EHD	B 185 APC	
F 2300 FAT 2300 HT	01/1990 - 10/1993	B 180 APC	B 180 EHD / B 160 EHD	B 185 APC	
F 2300 FAT 2305 DH	07/1978 - 12/1981	B 180 APC	B 180 EHD / B 160 EHD	B 185 APC	
F 2300 FAT 2305 DHR	07/1978 - 12/1981	B 180 APC	B 180 EHD / B 160 EHD	B 185 APC	
F 2300 FAT 2305 DHU,FAT 2335 DHT	07/1978 - 09/1986	B 180 APC	B 180 EHD / B 160 EHD	B 185 APC	
F 2300 FAT 2335 DHT	06/1986 - 08/1991	B 180 APC	B 180 EHD / B 160 EHD	B 185 APC	
F 2300 FAV 2300 HT	01/1990 - 10/1993	B 180 APC	B 180 EHD / B 160 EHD	B 185 APC	
F 2300 FMB 2305 DHU	07/1978 - 12/1983	B 180 APC	B 180 EHD / B 160 EHD	B 185 APC	
F 2300 FMT 2300 HT	01/1990 - 10/1993	B 180 APC	B 180 EHD / B 160 EHD	B 185 APC	
F 2300 FMT 2305 DHR	07/1978 - 12/1981	B 180 APC	B 180 EHD / B 160 EHD	B 185 APC	
F 2300 FMT 2305 DHU,FMT 2335 DHT	07/1978 - 09/1986	B 180 APC	B 180 EHD / B 160 EHD	B 185 APC	
F 2300 FMT 2335 DHT	06/1986 - 08/1991	B 180 APC	B 180 EHD / B 160 EHD	B 185 APC	
F 2300 FT 2300 DHU,FT 2305 DHU	07/1978 - 12/1983	B 180 APC	B 180 EHD / B 160 EHD	B 185 APC	
F 2300 FT 2300 HT	01/1990 - 10/1993	B 180 APC	B 180 EHD / B 160 EHD	B 185 APC	
F 2500 FA 2500 DHS	02/1982 - 08/1986	B 180 APC	B 180 EHD / B 160 EHD	B 185 APC	
F 2500 FA 2505 DHS	06/1986 - 08/1991	B 180 APC	B 180 EHD / B 160 EHD	B 185 APC	
F 2500 FAD 2535 DHS	02/1982 - 09/1986	B 180 APC	B 180 EHD / B 160 EHD	B 185 APC	
F 2500 FAD 2535 DHS	06/1986 - 08/1991	B 180 APC	B 180 EHD / B 160 EHD	B 185 APC	
F 2500 FAG 2500 DHS,FAG 2505 DHS,FAS 2503 DHS	06/1986 - 08/1991	B 180 APC	B 180 EHD / B 160 EHD	B 185 APC	
F 2500 FAG 2505 DHS,FAS 2503 DHS	02/1982 - 09/1986	B 180 APC	B 180 EHD / B 160 EHD	B 185 APC	
F 2500 FAT 2525 DHS	02/1982 - 09/1986	B 180 APC	B 180 EHD / B 160 EHD	B 185 APC	
F 2500 FAT 2525 DHS	06/1986 - 08/1991	B 180 APC	B 180 EHD / B 160 EHD	B 185 APC	
F 2500 FAT 2525 DHS,FAT 2535 DHS	06/1986 - 08/1991	B 180 APC	B 180 EHD / B 160 EHD	B 185 APC	
F 2500 FAT 2535 DHS	02/1982 - 09/1986	B 180 APC	B 180 EHD / B 160 EHD	B 185 APC	
F 2500 FMD 2525 DHS	02/1982 - 09/1986	B 180 APC	B 180 EHD / B 160 EHD	B 185 APC	
F 2500 FMD 2525 DHS,FMD 2535 DHS	06/1986 - 08/1991	B 180 APC	B 180 EHD / B 160 EHD	B 185 APC	
F 2500 FMT 2525 DHS	02/1982 - 09/1986	B 180 APC	B 180 EHD / B 160 EHD	B 185 APC	
F 2500 FMT 2525 DHS,FMT 2535 DHS	06/1986 - 08/1991	B 180 APC	B 180 EHD / B 160 EHD	B 185 APC	
F 2500 FT 2500 DHS	02/1982 - 09/1986	B 180 APC	B 180 EHD / B 160 EHD	B 185 APC	
F 2500 FT 2505 DHS	06/1986 - 08/1991	B 180 APC	B 180 EHD / B 160 EHD	B 185 APC	
F 2600 FA 2600 DKB	02/1972 - 12/1973	B 180 APC	B 180 EHD / B 160 EHD	B 185 APC	
F 2600 FAS 2600 DKB	02/1972 - 12/1973	B 180 APC	B 180 EHD / B 160 EHD	B 185 APC	
F 2600 FAT 2600 DKB	02/1972 - 12/1973	B 180 APC	B 180 EHD / B 160 EHD	B 185 APC	
F 2600 FT 2600 DKB	02/1972 - 12/1973	B 180 APC	B 180 EHD / B 160 EHD	B 185 APC	
F 2600 FTT 2600 DKB	02/1972 - 12/1973	B 180 APC	B 180 EHD / B 160 EHD	B 185 APC	
F 2700 FA 2700 HS	01/1990 - 10/1993	B 180 APC	B 180 EHD / B 160 EHD	B 185 APC	
F 2700 FAB 2700 HS,FAG 2700 HS,FAR2700 HS	01/1990 - 10/1993	B 180 APC	B 180 EHD / B 160 EHD	B 185 APC	
F 2700 FAT 2700 HS	01/1990 - 10/1993	B 180 APC	B 180 EHD / B 160 EHD	B 185 APC	

MARCHIO E MODELLO - MAKE AND MODEL MARQUE ET MODÈLE - MARKE UND MODELL MARCA Y MODELO - МАРКА И МОДЕЛЬ	Periodo Period	powerCUBE		energyCUBE	
		APC	EHD	APC	RST
DAF					
<i>cont.</i>					
F 2700 FMT 2700 HS	01/1990 - 10/1993	B 180 APC	B 180 EHD / B 160 EHD	B 185 APC	
F 2700 FT 2700 HS	01/1990 - 10/1993	B 180 APC	B 180 EHD / B 160 EHD	B 185 APC	
F 2800 FA 2800 DKA	01/1974 - 08/1980	B 180 APC	B 180 EHD / B 160 EHD	B 185 APC	
F 2800 FA 2800 DKS	01/1974 - 09/1986	B 180 APC	B 180 EHD / B 160 EHD	B 185 APC	
F 2800 FA 2800 DKSE	01/1980 - 09/1986	B 180 APC	B 180 EHD / B 160 EHD	B 185 APC	
F 2800 FA 2800 DKT	01/1974 - 11/1980	B 180 APC	B 180 EHD / B 160 EHD	B 185 APC	
F 2800 FA 2800 DKTD	01/1974 - 09/1986	B 180 APC	B 180 EHD / B 160 EHD	B 185 APC	
F 2800 FA 2800 DKTD	06/1986 - 09/1991	B 180 APC	B 180 EHD / B 160 EHD	B 185 APC	
F 2800 FA 2805 DKSE,FA 2800 DKV,FA 2800 DKXE	05/1983 - 09/1991	B 180 APC	B 180 EHD / B 160 EHD	B 185 APC	
F 2800 FAB 2805 DKS,FAR 2800 DKS,FAS 2800 DKS	01/1974 - 09/1986	B 180 APC	B 180 EHD / B 160 EHD	B 185 APC	
F 2800 FAB 2805 DKTD,FAS 2800 DKTD	01/1974 - 09/1986	B 180 APC	B 180 EHD / B 160 EHD	B 185 APC	
F 2800 FAC 2803 DKS	01/1974 - 09/1986	B 180 APC	B 180 EHD / B 160 EHD	B 185 APC	
F 2800 FAC 2803 DKSE	01/1980 - 07/1990	B 180 APC	B 180 EHD / B 160 EHD	B 185 APC	
F 2800 FAC 2803 DKTD	01/1974 - 09/1991	B 180 APC	B 180 EHD / B 160 EHD	B 185 APC	
F 2800 FAD 2805 DKS	01/1974 - 09/1986	B 180 APC	B 180 EHD / B 160 EHD	B 185 APC	
F 2800 FAD 2805 DKTD	01/1974 - 06/1986	B 180 APC	B 180 EHD / B 160 EHD	B 185 APC	
F 2800 FAD 2825 DKTD	01/1974 - 09/1991	B 180 APC	B 180 EHD / B 160 EHD	B 185 APC	
F 2800 FAD 2825 DKTD	06/1986 - 09/1991	B 180 APC	B 180 EHD / B 160 EHD	B 185 APC	
F 2800 FAD 2825 DKV	05/1983 - 09/1991	B 180 APC	B 180 EHD / B 160 EHD	B 185 APC	
F 2800 FAG 2800 DKV,FAR 2804 DKXE,FAS 2803 DKXE,DKSE,DKV	05/1983 - 09/1991	B 180 APC	B 180 EHD / B 160 EHD	B 185 APC	
F 2800 FAR 2804 DKSE,FAS 2800 DKT	01/1980 - 09/1986	B 180 APC	B 180 EHD / B 160 EHD	B 185 APC	
F 2800 FAS 2800 DKA	01/1974 - 11/1980	B 180 APC	B 180 EHD / B 160 EHD	B 185 APC	
F 2800 FAS 2803 DKS	06/1986 - 09/1991	B 180 APC	B 180 EHD / B 160 EHD	B 185 APC	
F 2800 FAS 2803 DKTD	06/1986 - 09/1991	B 180 APC	B 180 EHD / B 160 EHD	B 185 APC	
F 2800 FAT 2800 DKA	01/1974 - 11/1980	B 180 APC	B 180 EHD / B 160 EHD	B 185 APC	
F 2800 FAT 2800 DKS	01/1974 - 09/1986	B 180 APC	B 180 EHD / B 160 EHD	B 185 APC	
F 2800 FAT 2800 DKT	01/1974 - 11/1980	B 180 APC	B 180 EHD / B 160 EHD	B 185 APC	
F 2800 FAT 2800 DKTD	01/1974 - 09/1986	B 180 APC	B 180 EHD / B 160 EHD	B 185 APC	
F 2800 FAT 2805 DKS,FAT 2825 DKS	06/1986 - 09/1991	B 180 APC	B 180 EHD / B 160 EHD	B 185 APC	
F 2800 FAT 2805 DKTD,FAT 2825 DKTD	06/1986 - 09/1991	B 180 APC	B 180 EHD / B 160 EHD	B 185 APC	
F 2800 FMD 2805 DKTD,FMD 2825 DKTD	01/1974 - 09/1986	B 180 APC	B 180 EHD / B 160 EHD	B 185 APC	
F 2800 FMD 2805 DKTD,FMD 2825 DKTD	06/1986 - 09/1991	B 180 APC	B 180 EHD / B 160 EHD	B 185 APC	
F 2800 FMD 2825 DKV	05/1983 - 09/1991	B 180 APC	B 180 EHD / B 160 EHD	B 185 APC	
F 2800 FT 2800 DKA	01/1974 - 11/1980	B 180 APC	B 180 EHD / B 160 EHD	B 185 APC	
F 2800 FT 2800 DKS	01/1974 - 09/1986	B 180 APC	B 180 EHD / B 160 EHD	B 185 APC	
F 2800 FT 2800 DKSE,FT 2800DKXE,FT 2800 DKV	01/1980 - 09/1991	B 180 APC	B 180 EHD / B 160 EHD	B 185 APC	
F 2800 FT 2800 DKT	01/1974 - 11/1980	B 180 APC	B 180 EHD / B 160 EHD	B 185 APC	
F 2800 FT 2800 DKTD	01/1974 - 09/1986	B 180 APC	B 180 EHD / B 160 EHD	B 185 APC	
F 2800 FT 2805 DKS	06/1986 - 09/1991	B 180 APC	B 180 EHD / B 160 EHD	B 185 APC	
F 2800 FT 2805 DKTD	06/1986 - 09/1991	B 180 APC	B 180 EHD / B 160 EHD	B 185 APC	
F 2800 FTS 2800 DKA	01/1974 - 11/1980	B 180 APC	B 180 EHD / B 160 EHD	B 185 APC	
F 2800 FTS 2800 DKS	01/1974 - 09/1986	B 180 APC	B 180 EHD / B 160 EHD	B 185 APC	
F 2800 FTS 2800 DKT	01/1974 - 11/1980	B 180 APC	B 180 EHD / B 160 EHD	B 185 APC	
F 2800 FTS 2800 DKTD	01/1974 - 09/1986	B 180 APC	B 180 EHD / B 160 EHD	B 185 APC	
F 2800 FTS 2803 DKS	06/1986 - 09/1991	B 180 APC	B 180 EHD / B 160 EHD	B 185 APC	

MARCHIO E MODELLO - MAKE AND MODEL MARQUE ET MODÈLE - MARKE UND MODELL MARCA Y MODELO - МАРКА И МОДЕЛЬ	Periodo Period	powerCUBE		energyCUBE	
		APC	EHD	APC	RST
DAF	cont.				
F 2800 FTS 2803 DKTD	06/1986 - 09/1991	B 180 APC	B 180 EHD / B 160 EHD	B 185 APC	
F 2800 FTT 2800 DKA	01/1974 - 11/1980	B 180 APC	B 180 EHD / B 160 EHD	B 185 APC	
F 2800 FTT 2800 DKS	01/1974 - 09/1986	B 180 APC	B 180 EHD / B 160 EHD	B 185 APC	
F 2800 FTT 2800 DKT	01/1974 - 11/1980	B 180 APC	B 180 EHD / B 160 EHD	B 185 APC	
F 2800 FTT 2800 DKTD	01/1974 - 09/1986	B 180 APC	B 180 EHD / B 160 EHD	B 185 APC	
F 2800 FTT 2805 DKS,FTT 2815 DKS,FTT2825 DKS	06/1986 - 09/1991	B 180 APC	B 180 EHD / B 160 EHD	B 185 APC	
F 2800 FTT 2805 DKTD	06/1986 - 09/1991	B 180 APC	B 180 EHD / B 160 EHD	B 185 APC	
F 2900 FA 2900 KV	01/1990 - 10/1993	B 180 APC	B 180 EHD / B 160 EHD	B 185 APC	
F 2900 FAD 2900 KV	01/1990 - 10/1993	B 180 APC	B 180 EHD / B 160 EHD	B 185 APC	
F 2900 FAG 2900 KV,FAR 2900 KV,FAS 2900 KV	01/1990 - 10/1993	B 180 APC	B 180 EHD / B 160 EHD	B 185 APC	
F 2900 FMD 2900 KV	01/1990 - 10/1993	B 180 APC	B 180 EHD / B 160 EHD	B 185 APC	
F 2900 FT 2900 KV	01/1990 - 10/1993	B 180 APC	B 180 EHD / B 160 EHD	B 185 APC	
F 3200 FA 3200 KS	01/1990 - 10/1993	B 180 APC	B 180 EHD / B 160 EHD	B 185 APC	
F 3200 FAB 3200 KS,FAR 3200 KS,FAS 3200 KS	01/1990 - 10/1993	B 180 APC	B 180 EHD / B 160 EHD	B 185 APC	
F 3200 FAD 3200 KS	01/1990 - 10/1993	B 180 APC	B 180 EHD / B 160 EHD	B 185 APC	
F 3200 FAT 3200 KV	01/1990 - 10/1993	B 180 APC	B 180 EHD / B 160 EHD	B 185 APC	
F 3200 FMD 3200 KS	01/1990 - 10/1993	B 180 APC	B 180 EHD / B 160 EHD	B 185 APC	
F 3200 FT 3200 KS	01/1990 - 10/1993	B 180 APC	B 180 EHD / B 160 EHD	B 185 APC	
F 3300 FA 3300 DKX,FA 3305 DKX	06/1981 - 09/1986	B 180 APC	B 180 EHD / B 160 EHD	B 185 APC	
F 3300 FA 3300 DKX,FA 3305 DKX	06/1985 - 09/1991	B 180 APC	B 180 EHD / B 160 EHD	B 185 APC	
F 3300 FAB 3305 DKX,FAG 3300 DKX,FAR 3300 DKX,FAS 3303 DKX	06/1981 - 09/1986	B 180 APC	B 180 EHD / B 160 EHD	B 185 APC	
F 3300 FAC 3303 DKX	06/1981 - 09/1986	B 180 APC	B 180 EHD / B 160 EHD	B 185 APC	
F 3300 FAC 3303 DKX	06/1985 - 09/1991	B 180 APC	B 180 EHD / B 160 EHD	B 185 APC	
F 3300 FAD 3325 DKX	06/1981 - 09/1986	B 180 APC	B 180 EHD / B 160 EHD	B 185 APC	
F 3300 FAD 3325 DKX	06/1985 - 09/1991	B 180 APC	B 180 EHD / B 160 EHD	B 185 APC	
F 3300 FAG 3300 DKX,FAR 3304 DKX,FAS 3303 DKX	06/1985 - 09/1991	B 180 APC	B 180 EHD / B 160 EHD	B 185 APC	
F 3300 FAT 3325 DKX	06/1981 - 09/1986	B 180 APC	B 180 EHD / B 160 EHD	B 185 APC	
F 3300 FAT 3325 DKX	06/1985 - 09/1991	B 180 APC	B 180 EHD / B 160 EHD	B 185 APC	
F 3300 FT 3305 DKX	06/1981 - 09/1986	B 180 APC	B 180 EHD / B 160 EHD	B 185 APC	
F 3300 FT 3305 DKX	06/1985 - 09/1991	B 180 APC	B 180 EHD / B 160 EHD	B 185 APC	
F 3300 FTG 3300 DKX,FTS 3300 DKX	06/1981 - 09/1986	B 180 APC	B 180 EHD / B 160 EHD	B 185 APC	
F 3300 FTG 3300 DKX,FTS 3303 DKX	06/1985 - 09/1991	B 180 APC	B 180 EHD / B 160 EHD	B 185 APC	
F 3300 FTT 3325 DKX	06/1981 - 09/1986	B 180 APC	B 180 EHD / B 160 EHD	B 185 APC	
F 3300 FTT 3325 DKX	06/1985 - 09/1991	B 180 APC	B 180 EHD / B 160 EHD	B 185 APC	
F 3600 FA 3605 DKZ	06/1985 - 09/1991	B 180 APC	B 180 EHD / B 160 EHD	B 185 APC	
F 3600 FA 3605 DKZE	06/1985 - 09/1991	B 180 APC	B 180 EHD / B 160 EHD	B 185 APC	
F 3600 FAC 3603 DKZ	06/1985 - 09/1991	B 180 APC	B 180 EHD / B 160 EHD	B 185 APC	
F 3600 FAG 3600 DKZ,FAR 3604 DKZ,FAS 3603 DKZ	06/1985 - 09/1991	B 180 APC	B 180 EHD / B 160 EHD	B 185 APC	
F 3600 FAR 3604 DKZE,FAS 3603 DKZE	06/1985 - 09/1991	B 180 APC	B 180 EHD / B 160 EHD	B 185 APC	
F 3600 FT 3605 DKZ	06/1985 - 09/1991	B 180 APC	B 180 EHD / B 160 EHD	B 185 APC	
F 3600 FT 3605 DKZE	06/1985 - 09/1991	B 180 APC	B 180 EHD / B 160 EHD	B 185 APC	
F 3600 FTG 3600 DKZ,FTS 3603 DKZ	06/1985 - 09/1991	B 180 APC	B 180 EHD / B 160 EHD	B 185 APC	
F 3600 FTT 3625 DKZ	06/1985 - 09/1991	B 180 APC	B 180 EHD / B 160 EHD	B 185 APC	
F 500 FA 500 DE	12/1977 - 12/1979				CB 110 RST
F 600 FA 600 CD	12/1986 - 12/1992				CB 110 RST

MARCHIO E MODELLO - MAKE AND MODEL MARQUE ET MODÈLE - MARKE UND MODELL MARCA Y MODELO - МАРКА И МОДЕЛЬ	Periodo Period	powerCUBE		energyCUBE	
		APC	EHD	APC	RST
DAF <small>cont.</small>					
F 700 FA 700 DE	12/1975 - 12/1979				CB 110 RST
F 800 FA 800 CB	05/1987 - 08/1991				CB 110 RST
F 800 FA 800 CN	12/1986 - 08/1991				CB 110 RST
F 900 FA 900 BDD	01/1975 - 12/1981				CB 110 RST
F 900 FA 900 BDF	11/1981 - 11/1988				CB 110 RST
F 900 FA 900 BDT	11/1983 - 11/1988				CB 110 RST
F 900 FA 900 DE	01/1975 - 12/1981				CB 110 RST
LF FA 150	05/2013 -	B 180 APC	B 180 EHD	B 185 APC	
LF FA 180	05/2013 -	B 180 APC	B 180 EHD	B 185 APC	
LF FA 210	05/2013 -	B 180 APC	B 180 EHD	B 185 APC	
LF FA 220	05/2013 -	B 180 APC	B 180 EHD	B 185 APC	
LF FA 250	05/2013 -	B 180 APC	B 180 EHD	B 185 APC	
LF FA 280	05/2013 -	B 180 APC	B 180 EHD	B 185 APC	
LF FA 310	05/2013 -	B 180 APC	B 180 EHD	B 185 APC	
LF 45 45.220	01/2001 -				CH 125 RST
LF 45 FA 45.130	12/2005 -				CH 125 RST
LF 45 FA 45.140	05/2006 -				CH 125 RST
LF 45 FA 45.150	01/2001 -				CH 125 RST
LF 45 FA 45.160	05/2006 -				CH 125 RST
LF 45 FA 45.170	01/2001 -				CH 125 RST
LF 45 FA 45.180	01/2001 -				CH 125 RST
LF 45 FA 45.180	05/2006 -				CH 125 RST
LF 45 FA 45.210	01/2009 -				CB 110 RST
LF 45 FA 45.220	01/2001 -				CH 125 RST
LF 45 FA 45.220	05/2006 -				CH 125 RST
LF 45 FA 45.250	03/2006 -				CH 125 RST
LF 55 FA 55.160	05/2006 -				CH 125 RST
LF 55 FA 55.170	01/2001 -				CH 125 RST
LF 55 FA 55.180	01/2001 -				CH 125 RST
LF 55 FA 55.180	05/2006 -				CH 125 RST
LF 55 FA 55.210	01/2009 -				CH 125 RST
LF 55 FA 55.220	01/2001 -				CH 125 RST
LF 55 FA 55.220	05/2006 -				CH 125 RST
LF 55 FA 55.250	01/2001 -				CH 125 RST
LF 55 FA 55.250	05/2006 -				CH 125 RST
LF 55 FA 55.290	05/2006 -				CH 125 RST
LF 55 FA 55.300	01/2009 -				CH 125 RST
LF 55 FA LF.180	01/2001 -				CH 125 RST
LF 55 FAN 55.180	05/2006 -				CH 125 RST
LF 55 FAN 55.220	05/2006 -				CH 125 RST
LF 55 FAN 55.250	05/2006 -				CH 125 RST
LF 55 FAN 55.290	05/2006 -				CH 125 RST
LF 55 FT 55.180	01/2001 -				CH 125 RST
LF 55 FT 55.220	01/2001 -				CH 125 RST
LF 55 FT 55.220	05/2006 -				CH 125 RST

MARCHIO E MODELLO - MAKE AND MODEL MARQUE ET MODÈLE - MARKE UND MODELL MARCA Y MODELO - МАРКА И МОДЕЛЬ	Periodo Period	powerCUBE		energyCUBE	
		APC	EHD	APC	RST
DAF					
cont.					
LF 55 FT 55.250	01/2001 -				CH 125 RST
LF 55 FT 55.250	05/2006 -				CH 125 RST
LF 55 FT 55.290	05/2006 -				CH 125 RST
N 2800 NAT 2826 DKS	01/1981 - 09/1991	CX 225 APC	CX 200 EHD	CX 220 APC	
N 3300 NAT 3326 DKX	01/1981 - 09/1991	CX 225 APC	CX 200 EHD	CX 220 APC	
SB SB 120	01/1999 -	B 180 APC		B 185 APC	
SB SB 200	01/2001 -	CX 225 APC		CX 220 APC	
SB SB 2005	05/1980 -	CX 225 APC		CX 220 APC	
SB SB 201	01/1974 -	CX 225 APC		CX 220 APC	
SB SB 220	03/1998 -	CX 225 APC		CX 220 APC	
SB SB 220 LT		CX 225 APC		CX 220 APC	
SB SB 2300		CX 225 APC		CX 220 APC	
SB SB 3000		CX 225 APC		CX 220 APC	
XF FA 410	10/2012 -	B 180 APC		B 185 APC	
XF FA 440	10/2012 -	B 180 APC		B 185 APC	
XF FA 460	10/2012 -	B 180 APC		B 185 APC	
XF FA 510	10/2012 -	B 180 APC		B 185 APC	
XF FAR 410	10/2012 -	B 180 APC		B 185 APC	
XF FAR 440	10/2012 -	B 180 APC		B 185 APC	
XF FAR 460	10/2012 -	B 180 APC		B 185 APC	
XF FAR 510	10/2012 -	B 180 APC		B 185 APC	
XF FT 410	10/2012 -	B 180 APC		B 185 APC	
XF FT 440	10/2012 -	B 180 APC		B 185 APC	
XF FT 460	10/2012 -	B 180 APC		B 185 APC	
XF FT 510	10/2012 -	B 180 APC		B 185 APC	
XF FTP 410	10/2012 -	B 180 APC		B 185 APC	
XF FTP 440	10/2012 -	B 180 APC		B 185 APC	
XF FTP 460	10/2012 -	B 180 APC		B 185 APC	
XF FTP 510	10/2012 -	B 180 APC		B 185 APC	
XF 105 FA XF105.410	10/2005 -	B 180 APC	B 180 EHD	B 185 APC	
XF 105 FA XF105.460	10/2005 -	B 180 APC	B 180 EHD	B 185 APC	
XF 105 FA XF105.510	10/2005 -	B 180 APC	B 180 EHD	B 185 APC	
XF 105 FAD 105.410	10/2005 -	B 180 APC	B 180 EHD	B 185 APC	
XF 105 FAD 105.460	10/2005 -	B 180 APC	B 180 EHD	B 185 APC	
XF 105 FAD 105.510	10/2005 -	B 180 APC	B 180 EHD	B 185 APC	
XF 105 FAK 105.410	10/2005 -	B 180 APC	B 180 EHD	B 185 APC	
XF 105 FAK 105.460	10/2005 -	B 180 APC	B 180 EHD	B 185 APC	
XF 105 FAK 105.510	10/2005 -	B 180 APC	B 180 EHD	B 185 APC	
XF 105 FAS XF105.410 ,FAR XF105.410 ,FAN XF105.410	10/2005 -	B 180 APC	B 180 EHD	B 185 APC	
XF 105 FAS XF105.460, FAR XF105.460, FAN XF105.460	10/2005 -	B 180 APC	B 180 EHD	B 185 APC	
XF 105 FAS XF105.510, FAR XF105.510, FAN XF105.510	10/2005 -	B 180 APC	B 180 EHD	B 185 APC	
XF 105 FAT 105.410	10/2005 -	B 180 APC	B 180 EHD	B 185 APC	
XF 105 FAT 105.460	10/2005 -	B 180 APC	B 180 EHD	B 185 APC	
XF 105 FAT 105.510	10/2005 -	B 180 APC	B 180 EHD	B 185 APC	
XF 105 FT XF105.410	10/2005 -	B 180 APC	B 180 EHD	B 185 APC	

MARCHIO E MODELLO - MAKE AND MODEL MARQUE ET MODÈLE - MARKE UND MODELL MARCA Y MODELO - МАРКА И МОДЕЛЬ	Periodo Period	powerCUBE		energyCUBE	
		APC	EHD	APC	RST
DAF					
cont.					
XF 105 FT XF105.460	10/2005 -	B 180 APC	B 180 EHD	B 185 APC	
XF 105 FT XF105.510	10/2005 -	B 180 APC	B 180 EHD	B 185 APC	
XF 105 FTM 105.410	10/2005 -	B 180 APC	B 180 EHD	B 185 APC	
XF 105 FTM 105.460	10/2005 -	B 180 APC	B 180 EHD	B 185 APC	
XF 105 FTM 105.510	10/2005 -	B 180 APC	B 180 EHD	B 185 APC	
XF 105 FTP 105.410	10/2005 -	B 180 APC	B 180 EHD	B 185 APC	
XF 105 FTP 105.460	10/2005 -	B 180 APC	B 180 EHD	B 185 APC	
XF 105 FTP 105.510	10/2005 -	B 180 APC	B 180 EHD	B 185 APC	
XF 105 FTS 105.410, FTR 105.410, FTG 105.410	10/2005 -	B 180 APC	B 180 EHD	B 185 APC	
XF 105 FTS 105.460, FTR 105.460, FTG 105.460	10/2005 -	B 180 APC	B 180 EHD	B 185 APC	
XF 105 FTS 105.510, FTR 105.510, FTG 105.510	10/2005 -	B 180 APC	B 180 EHD	B 185 APC	
XF 105 FTT 105.410	10/2005 -	B 180 APC	B 180 EHD	B 185 APC	
XF 105 FTT 105.460	10/2005 -	B 180 APC	B 180 EHD	B 185 APC	
XF 105 FTT 105.510	10/2005 -	B 180 APC	B 180 EHD	B 185 APC	
XF 95 FA 95.380	09/2002 - 12/2006	B 180 APC	B 180 EHD	B 185 APC	
XF 95 FA 95.430	09/2002 - 12/2006	B 180 APC	B 180 EHD	B 185 APC	
XF 95 FA 95.480	09/2002 - 12/2006	B 180 APC	B 180 EHD	B 185 APC	
XF 95 FA 95.530	09/2002 - 12/2006	B 180 APC	B 180 EHD	B 185 APC	
XF 95 FAD 95.380		B 180 APC	B 180 EHD	B 185 APC	
XF 95 FAD 95.430		B 180 APC	B 180 EHD	B 185 APC	
XF 95 FAD 95.480		B 180 APC	B 180 EHD	B 185 APC	
XF 95 FAD 95.530	09/2002 -	B 180 APC	B 180 EHD	B 185 APC	
XF 95 FAK 95.380		B 180 APC	B 180 EHD	B 185 APC	
XF 95 FAK 95.430		B 180 APC	B 180 EHD	B 185 APC	
XF 95 FAK 95.480		B 180 APC	B 180 EHD	B 185 APC	
XF 95 FAK 95.530	09/2002 -	B 180 APC	B 180 EHD	B 185 APC	
XF 95 FAN 95.380		B 180 APC	B 180 EHD	B 185 APC	
XF 95 FAN 95.430		B 180 APC	B 180 EHD	B 185 APC	
XF 95 FAN 95.480		B 180 APC	B 180 EHD	B 185 APC	
XF 95 FAN 95.530	09/2002 -	B 180 APC	B 180 EHD	B 185 APC	
XF 95 FAR 95.380	09/2002 - 12/2006	B 180 APC	B 180 EHD	B 185 APC	
XF 95 FAR 95.430	09/2002 - 12/2006	B 180 APC	B 180 EHD	B 185 APC	
XF 95 FAR 95.480	09/2002 - 12/2006	B 180 APC	B 180 EHD	B 185 APC	
XF 95 FAR 95.530	09/2002 - 12/2006	B 180 APC	B 180 EHD	B 185 APC	
XF 95 FAS 95.380		B 180 APC	B 180 EHD	B 185 APC	
XF 95 FAS 95.430		B 180 APC	B 180 EHD	B 185 APC	
XF 95 FAS 95.480		B 180 APC	B 180 EHD	B 185 APC	
XF 95 FAS 95.530	09/2002 -	B 180 APC	B 180 EHD	B 185 APC	
XF 95 FAT 95.380		B 180 APC	B 180 EHD	B 185 APC	
XF 95 FAT 95.430		B 180 APC	B 180 EHD	B 185 APC	
XF 95 FAT 95.480		B 180 APC	B 180 EHD	B 185 APC	
XF 95 FAT 95.530	09/2002 -	B 180 APC	B 180 EHD	B 185 APC	
XF 95 FT 315	09/2002 - 12/2006	B 180 APC	B 180 EHD	B 185 APC	
XF 95 FT 355	09/2002 - 12/2006	B 180 APC	B 180 EHD	B 185 APC	
XF 95 FT 95.380	09/2002 - 12/2006	B 180 APC	B 180 EHD	B 185 APC	

MARCHIO E MODELLO - MAKE AND MODEL MARQUE ET MODÈLE - MARKE UND MODELL MARCA Y MODELO - МАРКА И МОДЕЛЬ	Periodo Period	powerCUBE		energyCUBE	
		APC	EHD	APC	RST
DAF					
cont.					
XF 95 FT 95.530	09/2002 - 12/2006	B 180 APC	B 180 EHD	B 185 APC	
XF 95 FTG 95.380	09/2002 - 12/2006	B 180 APC	B 180 EHD	B 185 APC	
XF 95 FTG 95.430	12/2005 - 12/2006	B 180 APC	B 180 EHD	B 185 APC	
XF 95 FTG 95.480	12/2005 - 12/2006	B 180 APC	B 180 EHD	B 185 APC	
XF 95 FTG 95.530	09/2002 - 12/2006	B 180 APC	B 180 EHD	B 185 APC	
XF 95 FTM 95.380	12/2005 - 12/2006	B 180 APC	B 180 EHD	B 185 APC	
XF 95 FTM 95.430	12/2005 - 12/2006	B 180 APC	B 180 EHD	B 185 APC	
XF 95 FTM 95.480	12/2005 - 12/2006	B 180 APC	B 180 EHD	B 185 APC	
XF 95 FTM 95.530	09/2002 - 12/2006	B 180 APC	B 180 EHD	B 185 APC	
XF 95 FTP 95.380		B 180 APC	B 180 EHD	B 185 APC	
XF 95 FTP 95.430		B 180 APC	B 180 EHD	B 185 APC	
XF 95 FTP 95.480		B 180 APC	B 180 EHD	B 185 APC	
XF 95 FTP 95.530	09/2002 -	B 180 APC	B 180 EHD	B 185 APC	
XF 95 FTR 95.380		B 180 APC	B 180 EHD	B 185 APC	
XF 95 FTR 95.430		B 180 APC	B 180 EHD	B 185 APC	
XF 95 FTR 95.480		B 180 APC	B 180 EHD	B 185 APC	
XF 95 FTR 95.530	09/2002 -	B 180 APC	B 180 EHD	B 185 APC	
XF 95 FTS 95.380		B 180 APC	B 180 EHD	B 185 APC	
XF 95 FTS 95.430		B 180 APC	B 180 EHD	B 185 APC	
XF 95 FTS 95.480		B 180 APC	B 180 EHD	B 185 APC	
XF 95 FTS 95.530	09/2002 -	B 180 APC	B 180 EHD	B 185 APC	
XF 95 FTT 95.380		B 180 APC	B 180 EHD	B 185 APC	
XF 95 FTT 95.430		B 180 APC	B 180 EHD	B 185 APC	
XF 95 FTT 95.480		B 180 APC	B 180 EHD	B 185 APC	
XF 95 FTT 95.530	09/2002 -	B 180 APC	B 180 EHD	B 185 APC	
DAIHATSU					
ROCKY Hard Top (F7, F8) 2.8 TD	09/1991 - 12/1998				AT 100 RSTd
FORD					
5000-Serie 5030	01/1992 - 12/1999				CB 110 RST
5000-Serie 5100	01/1988 - 12/1991				CB 110 RST
5000-Serie 5900	01/1985 - 12/1993				MC 130 RST
6000-Serie 6410	01/1988 - 12/1991				MC 130 RST
6000-Serie 6810	01/1988 - 12/1991				MC 130 RST
Cargo 0609	01/1982 - 01/1996				CBX 110 RST
Cargo 0709	01/1982 - 01/1996				CBX 110 RST
Cargo 0711	01/1982 - 01/1996				CBX 110 RST
Cargo 0712, 0713	05/1981 - 01/1987				CBX 110 RST

MARCHIO E MODELLO - MAKE AND MODEL MARQUE ET MODÈLE - MARKE UND MODELL MARCA Y MODELO - МАРКА И МОДЕЛЬ	Periodo Period	powerCUBE		energyCUBE	
		APC	EHD	APC	RST
FORD					
<i>cont.</i>					
Cargo 0809	01/1982 - 01/1996				CBX 110 RST
Cargo 0809 K	01/1982 - 01/1996				CBX 110 RST
Cargo 0811	01/1982 - 01/1996				CBX 110 RST
Cargo 0812, 0813	05/1981 - 01/1987				CBX 110 RST
Cargo 0913	01/1982 - 01/1996				CBX 110 RST
Cargo 0915	01/1982 - 01/1996				CBX 110 RST
Cargo 1013	01/1982 - 06/1994				CBX 110 RST
Cargo 1113	01/1982 - 01/1996				CBX 110 RST
Cargo 1115	01/1982 - 01/1996				CBX 110 RST
Cargo 1215	01/1982 - 01/1996				CBX 110 RST
Cargo 1826	09/2004 -	A 135 APC	A 140 EHD		
Cargo 1826D	09/2004 -	A 135 APC	A 140 EHD		
Cargo 1832	09/2004 -	A 135 APC	A 140 EHD		
Cargo 1838 T	09/2004 -	A 135 APC	A 140 EHD		
Cargo 2526	09/2004 -	A 135 APC	A 140 EHD		
Cargo 2526D	09/2004 -	A 135 APC	A 140 EHD		
Cargo 2532	09/2004 -	A 135 APC	A 140 EHD		
Cargo 2532D	09/2004 -	A 135 APC	A 140 EHD		
Cargo 2538, 2538F	09/2004 -	A 135 APC	A 140 EHD		
Cargo 3232C, 3232S	09/2004 -	A 135 APC	A 140 EHD		
Cargo 3232CD, 3232SD	09/2004 -	A 135 APC	A 140 EHD		
Cargo 3238C, 3238S	09/2004 -	A 135 APC	A 140 EHD		
Cargo 3532D	09/2004 -	A 135 APC	A 140 EHD		
Cargo 3532M	09/2004 -	A 135 APC	A 140 EHD		
Cargo 3536D	09/2004 -	A 135 APC	A 140 EHD		
Cargo 3936M	09/2004 -	A 135 APC	A 140 EHD		
Cargo 4136D	09/2004 -	A 135 APC	A 140 EHD		
IRISBUS					
ACCESS'BUS 127 GX 127	03/2006 -	CX 225 APC	CX 200 EHD	CX 220 APC	
ACCESS'BUS 127 GX 127 L	03/2006 -	CX 225 APC	CX 200 EHD	CX 220 APC	
ACCESS'BUS 127 GX 127, GX 127 L		CX 225 APC		CX 220 APC	
AGORA Agora L	01/2003 - 12/2005	CX 225 APC		CX 220 APC	
AGORA Agora L	01/2003 -	CX 225 APC		CX 220 APC	
AGORA Agora S	01/2003 - 12/2005	CX 225 APC		CX 220 APC	
AGORA Agora S	01/2003 -	CX 225 APC		CX 220 APC	
ARWAY 12M, 12.8M	06/2006 -	CX 225 APC	CX 200 EHD	CX 220 APC	
ARWAY 15M		CX 225 APC		CX 220 APC	
AXER 12.8m	03/2005 - 01/2007	CX 225 APC	CX 200 EHD	CX 220 APC	
AXER 12M, 12.8M	03/2005 - 01/2007	CX 225 APC	CX 200 EHD	CX 220 APC	
CITELIS 10.5 CNG, 12 CNG		CX 225 APC		CX 220 APC	
CITELIS 12, LINE	09/2005 -	CX 225 APC	CX 200 EHD	CX 220 APC	

MARCHIO E MODELLO - MAKE AND MODEL MARQUE ET MODÈLE - MARKE UND MODELL MARCA Y MODELO - МАРКА И МОДЕЛЬ	Periodo Period	powerCUBE		energyCUBE	
		APC	EHD	APC	RST
IRISBUS					
cont.					
CITELIS 18	09/2005 -	CX 225 APC	CX 200 EHD	CX 220 APC	
CITELIS 18 CNG		CX 225 APC		CX 220 APC	
CITELIS 18 CNG	09/2005 -	CX 225 APC	CX 200 EHD	CX 220 APC	
CREALIS 12 CNG, 12 NEO CNG		CX 225 APC		CX 220 APC	
CREALIS 12, 12 NEO		CX 225 APC		CX 220 APC	
CREALIS 18 CNG, 18 NEO CNG		CX 225 APC		CX 220 APC	
CREALIS 18, 18 NEO		CX 225 APC		CX 220 APC	
CROSSWAY 10.6m	06/2006 -	CX 225 APC	CX 200 EHD	CX 220 APC	
CROSSWAY 10.6m, 12m, 12.8m		CX 225 APC		CX 220 APC	
CROSSWAY 10.6m, 12m, 12.8m	06/2006 -	CX 225 APC	CX 200 EHD	CX 220 APC	
CROSSWAY 12M, 12.8M		CX 225 APC		CX 220 APC	
DAILY TOURYS 16, 19	11/2006 -				CB 110 RST (B01)
DOMINO 2001	10/2003 -	CX 225 APC	CX 200 EHD	CX 220 APC	
DOMINO HD	06/2006 -	CX 225 APC	CX 200 EHD	CX 220 APC	
DOMINO HD, HDH	06/2006 -	CX 225 APC	CX 200 EHD	CX 220 APC	
EVADYS H 12m, 12.8m	10/2003 -	CX 225 APC	CX 200 EHD	CX 220 APC	
EVADYS HD 12m	10/2003 -	CX 225 APC	CX 200 EHD	CX 220 APC	
MAGELYS HD	08/2008 -	CX 225 APC		CX 220 APC	
PROWAY Short, Long		CX 225 APC		CX 220 APC	
RECREO 12M, 12.8M	10/2003 - 01/2007	CX 225 APC	CX 200 EHD	CX 220 APC	
IVECO					
370 370.20, 370.24		CX 225 APC		CX 220 APC	
370 370.25		CX 225 APC		CX 220 APC	
370 370.26		CX 225 APC		CX 220 APC	
370 370.30, 370.S30	01/1989 - 12/1999	CX 225 APC		CX 220 APC	
370 370.35		CX 225 APC		CX 220 APC	
City Class 491.22 491.27 591.22 591.27	01/1997 -	CX 225 APC		CX 220 APC	
DAILY II Cassone / Furgonato / Promiscuo 2.8	11/1997 - 07/2007				CB 110 RST (B01)
DAILY II Cassone / Furgonato / Promiscuo 29 L 10 V (ALJA43A2, ALJA42A2, ALJA41A2)	09/2002 -				CB 110 RST
DAILY II Cassone / Furgonato / Promiscuo 29 L 11 V	05/1999 -				CB 110 RST
DAILY II Cassone / Furgonato / Promiscuo 29 L 12 V (ALKA41A2, ALLA52A2, ALKA42A2)	09/2002 -				CB 110 RST
DAILY II Cassone / Furgonato / Promiscuo 29 L 13	05/2001 -				CB 110 RST
DAILY II Cassone / Furgonato / Promiscuo 29 L 14	01/2005 - 04/2006				CB 110 RST (B01)
DAILY II Cassone / Furgonato / Promiscuo 29 L 9 V	05/1999 -				CB 110 RST
DAILY II Cassone / Furgonato / Promiscuo 29 L 9 V	11/2001 - 04/2006				CB 110 RST (B01)
DAILY II Cassone / Furgonato / Promiscuo 35 C 12 V, 35 S 12 V (AGKA43A2, AGKB43A2, AGKB46A2, AGKC43A2)	09/2002 -				CB 110 RST
DAILY II Cassone / Furgonato / Promiscuo 35 C 14	09/2004 - 04/2006				CB 110 RST (B01)
DAILY II Cassone / Furgonato / Promiscuo 35 C 14, 35 S 14	01/2005 - 04/2006				CB 110 RST (B01)

MARCHIO E MODELLO - <i>MAKE AND MODEL</i> MARQUE ET MODÈLE - <i>MARKE UND MODELL</i> MARCA Y MODELO - <i>МАРКА И МОДЕЛЬ</i>	Periodo <i>Period</i>	powerCUBE		energyCUBE	
		APC	EHD	APC	RST
IVECO <i>cont.</i>					
DAILY II Cassone / Furgonato / Promiscuo 35 C 17, 35 S 17	01/2005 - 04/2006				CB 110 RST (B01)
DAILY II Cassone / Furgonato / Promiscuo 35 S 10 (ANJA41A1, ANJA42A2, ANJA42AB, ANJA43A, ANJAV1A, AGJ)	09/2002 -				CB 110 RST
DAILY II Cassone / Furgonato / Promiscuo 35 S 11 V, 35 C 11 V	05/1999 -				CB 110 RST
DAILY II Cassone / Furgonato / Promiscuo 35 S 13 V, 35 C 13 V	05/1999 -				CB 110 RST
DAILY II Cassone / Furgonato / Promiscuo 35 S 15 V, 35 C 15 V (A6HCV3B2, A6HBV4B2, A6HC41B2, A6HC42B2)	11/2002 -				CB 110 RST
DAILY II Cassone / Furgonato / Promiscuo 35 S 9 V	11/2001 - 04/2006				CB 110 RST (B01)
DAILY II Cassone / Furgonato / Promiscuo 35 S 9 V, 35 C 9 V	05/1999 -				CB 110 RST
DAILY II Cassone / Furgonato / Promiscuo 40 C 13	05/1999 - 04/2006				CB 110 RST (B01)
DAILY II Cassone / Furgonato / Promiscuo 40 C 14	01/2005 - 04/2006				CB 110 RST (B01)
DAILY II Cassone / Furgonato / Promiscuo 40 C 14	09/2004 - 04/2006				CB 110 RST (B01)
DAILY II Cassone / Furgonato / Promiscuo 40 C 15	11/2001 - 04/2006				CB 110 RST (B01)
DAILY II Cassone / Furgonato / Promiscuo 40 C 17, 40 S 17	01/2005 - 04/2006				CB 110 RST (B01)
DAILY II Cassone / Furgonato / Promiscuo 45 C 14	07/1999 - 04/2006				CB 110 RST (B01)
DAILY II Cassone / Furgonato / Promiscuo 50 C 11	05/1999 -				CB 110 RST
DAILY II Cassone / Furgonato / Promiscuo 50 C 13	05/1999 -				CB 110 RST
DAILY II Cassone / Furgonato / Promiscuo 50 C 14	09/2004 - 04/2006				CB 110 RST (B01)
DAILY II Cassone / Furgonato / Promiscuo 50 C 15	01/2001 - 04/2006				CB 110 RST (B01)
DAILY II Cassone / Furgonato / Promiscuo 50 C 17	09/2004 - 04/2006				CB 110 RST (B01)
DAILY II Cassone / Furgonato / Promiscuo 65 C 14	09/2004 - 04/2006				CB 110 RST (B01)
DAILY II Cassone / Furgonato / Promiscuo 65 C 15	11/2001 - 04/2006				CB 110 RST (B01)
DAILY II Cassone / Furgonato / Promiscuo 65 C 17	09/2004 - 04/2006				CB 110 RST (B01)
DAILY II Pianale piatto/Telaio 29 L 10 (ALJAV1A1, ALJA41AA, ALJA41A1, AHJA64A1, AHJA14A1, A)	09/2002 -				CB 110 RST
DAILY II Pianale piatto/Telaio 29 L 11	05/1999 -				CB 110 RST
DAILY II Pianale piatto/Telaio 29 L 12 (ALKA41A1, AHKA64A1, ALLA51A1)	09/2002 -				CB 110 RST
DAILY II Pianale piatto/Telaio 29 L 13	11/2001 -				CB 110 RST
DAILY II Pianale piatto/Telaio 29 L 14 (AHRA11C1B1, AHRA14C1B1, AHRA64C1B1)	11/2005 -				CB 110 RST
DAILY II Pianale piatto/Telaio 29 L 9	05/1999 -				CB 110 RST
DAILY II Pianale piatto/Telaio 29 L 9	11/2001 - 04/2006				CB 110 RST (B01)
DAILY II Pianale piatto/Telaio 35 C 10 V, 35 S 10 V (AMJA11A1, AMJA14A1, AMJA64A1, AMJA65A)	09/2002 -				CB 110 RST
DAILY II Pianale piatto/Telaio 35 C 12, 35 S 12 (AEKA14A1, AEKA14AA, AEKA64A1, AEKB11A1, A)	09/2002 -				CB 110 RST
DAILY II Pianale piatto/Telaio 35 C 14	09/2004 - 04/2006				CB 110 RST (B01)
DAILY II Pianale piatto/Telaio 35 C 14, 35 S 14	01/2005 - 04/2006				CB 110 RST (B01)
DAILY II Pianale piatto/Telaio 35 C 15	11/2001 -				CB 110 RST
DAILY II Pianale piatto/Telaio 35 C 17, 35 S 17	01/2005 - 04/2006				CB 110 RST (B01)
DAILY II Pianale piatto/Telaio 35 C 9, 35 S 9	11/2001 - 04/2006				CB 110 RST (B01)
DAILY II Pianale piatto/Telaio 35 S 11, 35 C 11	05/1999 -				CB 110 RST
DAILY II Pianale piatto/Telaio 35 S 13, 35 C 13	05/1999 -				CB 110 RST
DAILY II Pianale piatto/Telaio 35 S 9, 35 C 9	05/1999 -				CB 110 RST

MARCHIO E MODELLO - MAKE AND MODEL MARQUE ET MODÈLE - MARKE UND MODELL MARCA Y MODELO - МАРКА И МОДЕЛЬ	Periodo Period	powerCUBE		energyCUBE	
		APC	EHD	APC	RST
IVECO cont.					
DAILY II Pianale piatto/Telaio 40 C 13	05/1999 - 04/2006				CB 110 RST (B01)
DAILY II Pianale piatto/Telaio 40 C 14	01/2005 - 04/2006				CB 110 RST (B01)
DAILY II Pianale piatto/Telaio 40 C 14	09/2004 - 04/2006				CB 110 RST (B01)
DAILY II Pianale piatto/Telaio 40 C 15	11/2001 - 04/2006				CB 110 RST (B01)
DAILY II Pianale piatto/Telaio 40 C 17, 40 S 17	01/2005 - 04/2006				CB 110 RST (B01)
DAILY II Pianale piatto/Telaio 50 C 11	05/1999 -				CB 110 RST
DAILY II Pianale piatto/Telaio 50 C 13	05/1999 -				CB 110 RST
DAILY II Pianale piatto/Telaio 50 C 14	09/2004 - 04/2006				CB 110 RST (B01)
DAILY II Pianale piatto/Telaio 50 C 15	01/2001 -				CB 110 RST
DAILY II Pianale piatto/Telaio 50 C 17	09/2004 - 04/2006				CB 110 RST (B01)
DAILY II Pianale piatto/Telaio 65 C 14	09/2004 - 04/2006				CB 110 RST (B01)
DAILY II Pianale piatto/Telaio 65 C 15	11/2001 -				CB 110 RST
DAILY II Pianale piatto/Telaio 65 C 17	09/2004 - 04/2006				CB 110 RST (B01)
DAILY III Bus 35S14	05/2006 -				CB 110 RST (B01)
DAILY III Bus 35S14 G	07/2009 -				CB 110 RST (B01)
DAILY III Cassone / Furgonato / Promiscuo 29L10 V	05/2006 -				CB 110 RST (B01)
DAILY III Cassone / Furgonato / Promiscuo 29L12 V, 29L12 V/P	05/2006 -				CB 110 RST (B01)
DAILY III Cassone / Furgonato / Promiscuo 29L14 C, 29L14 C/P, 29L14 V, 29L14 V/P	05/2006 -				CB 110 RST (B01)
DAILY III Cassone / Furgonato / Promiscuo 35C10, 35S10	05/2006 -				CB 110 RST (B01)
DAILY III Cassone / Furgonato / Promiscuo 35C11 V, 35S11 V	07/2007 -				CB 110 RST (B01)
DAILY III Cassone / Furgonato / Promiscuo 35C12 V, 35C12 V/P, 35S12 V, 35S12 V/P	05/2006 -				CB 110 RST (B01)
DAILY III Cassone / Furgonato / Promiscuo 35C13 V, 35C13 V/P, 35S13 V, 35S13 V/P	07/2007 -				CB 110 RST (B01)
DAILY III Cassone / Furgonato / Promiscuo 35C14 GV, 35C14 GV/P, 35S14 GV, 35S14 GV/P	07/2007 -				CB 110 RST (B01)
DAILY III Cassone / Furgonato / Promiscuo 35C14 V, 35C14 V/P, 35S14 V, 35S14 V/P	07/2007 -				CB 110 RST (B01)
DAILY III Cassone / Furgonato / Promiscuo 35C15 V, 35C15 V/P	05/2006 -				CB 110 RST (B01)
DAILY III Cassone / Furgonato / Promiscuo 35C17 V, 35C17 V/P, 35S17 V, 35S17 V/P	07/2007 -				CB 110 RST (B01)
DAILY III Cassone / Furgonato / Promiscuo 35C18 V, 35C18 V/P, 35S18 V, 35S18 V/P	05/2006 -				CB 110 RST (B01)
DAILY III Cassone / Furgonato / Promiscuo 35S14 C, 35S14 C/P, 35S14 V, 35S14 V/P, 35C14 V, 35C14 V/P	05/2006 -				CB 110 RST (B01)
DAILY III Cassone / Furgonato / Promiscuo 35S15	06/2006 -				CB 110 RST (B01)
DAILY III Cassone / Furgonato / Promiscuo 40C10 V	05/2006 -				CB 110 RST (B01)
DAILY III Cassone / Furgonato / Promiscuo 40C11 V	07/2007 -				CB 110 RST (B01)
DAILY III Cassone / Furgonato / Promiscuo 40C12 V, 40C14 V/P	05/2006 -				CB 110 RST (B01)
DAILY III Cassone / Furgonato / Promiscuo 40C13 V, 40C13 V/P	07/2007 -				CB 110 RST (B01)
DAILY III Cassone / Furgonato / Promiscuo 40C14 GV, 40C14 GV/P, 40S14 GV, 40S14 GV/P	07/2007 -				CB 110 RST (B01)
DAILY III Cassone / Furgonato / Promiscuo 40C14 V, 40C14 V/P, 40S14 V, 40S14 V/P	07/2007 -				CB 110 RST (B01)

MARCHIO E MODELLO - MAKE AND MODEL MARQUE ET MODÈLE - MARKE UND MODELL MARCA Y MODELO - МАРКА И МОДЕЛЬ	Periodo Period	powerCUBE		energyCUBE	
		APC	EHD	APC	RST
IVECO cont.					
DAILY III Cassone / Furgonato / Promiscuo 40C15 V, 40C15 V/P	05/2006 -				CB 110 RST (B01)
DAILY III Cassone / Furgonato / Promiscuo 40C17 V, 40C17 V/P	07/2007 -				CB 110 RST (B01)
DAILY III Cassone / Furgonato / Promiscuo 40C18 V, 40C18 V/P	05/2006 -				CB 110 RST (B01)
DAILY III Cassone / Furgonato / Promiscuo 45C15 V	05/2006 -				CB 110 RST (B01)
DAILY III Cassone / Furgonato / Promiscuo 45C17 V, 45C17 V/P	07/2007 -				CB 110 RST (B01)
DAILY III Cassone / Furgonato / Promiscuo 45C18	05/2006 -				CB 110 RST (B01)
DAILY III Cassone / Furgonato / Promiscuo 50C14 GV, 50C14 GV/P	07/2007 -				CB 110 RST (B01)
DAILY III Cassone / Furgonato / Promiscuo 50C14 V, 50C14 V/P	07/2007 -				CB 110 RST (B01)
DAILY III Cassone / Furgonato / Promiscuo 50C15	05/2006 -				CB 110 RST (B01)
DAILY III Cassone / Furgonato / Promiscuo 50C17 V, 50C17 V/P	07/2007 -				CB 110 RST (B01)
DAILY III Cassone / Furgonato / Promiscuo 50C18	05/2006 -				CB 110 RST (B01)
DAILY III Cassone / Furgonato / Promiscuo 55C17	08/2007 - 03/2012				CB 110 RST (B01)
DAILY III Cassone / Furgonato / Promiscuo 60C15 V	05/2006 -				CB 110 RST (B01)
DAILY III Cassone / Furgonato / Promiscuo 60C17 V, 60C17 V/P	07/2007 -				CB 110 RST (B01)
DAILY III Cassone / Furgonato / Promiscuo 60C18	05/2006 -				CB 110 RST (B01)
DAILY III Cassone / Furgonato / Promiscuo 65C14 V, 65C14 V/P	07/2007 -				CB 110 RST (B01)
DAILY III Cassone / Furgonato / Promiscuo 65C15	05/2006 -				CB 110 RST (B01)
DAILY III Cassone / Furgonato / Promiscuo 65C17 V, 65C17 V/P	07/2007 -				CB 110 RST (B01)
DAILY III Cassone / Furgonato / Promiscuo 65C18	05/2006 -				CB 110 RST (B01)
DAILY III Cassone / Furgonato / Promiscuo 70C14 V, 70C14 V/P	07/2007 -				CB 110 RST (B01)
DAILY III Cassone / Furgonato / Promiscuo 70C17V, 70C17 V/P	07/2007 -				CB 110 RST (B01)
DAILY III Pianale piatto/Telaio 29L10	05/2006 -				CB 110 RST (B01)
DAILY III Pianale piatto/Telaio 29L12	05/2006 -				CB 110 RST (B01)
DAILY III Pianale piatto/Telaio 29L14	05/2006 -				CB 110 RST (B01)
DAILY III Pianale piatto/Telaio 35C10, 35S10	05/2006 -				CB 110 RST (B01)
DAILY III Pianale piatto/Telaio 35C11, 35S11, 35S11 D	07/2007 -				CB 110 RST (B01)
DAILY III Pianale piatto/Telaio 35C12, 35S12	05/2006 -				CB 110 RST (B01)
DAILY III Pianale piatto/Telaio 35C13, 35C13 /P, 35S13 D, 35S13, 35S13 /P	07/2007 -				CB 110 RST (B01)
DAILY III Pianale piatto/Telaio 35C14 G, 35C14 G/P, 35S14 G, 35S14 G/P, 35C14 GD, 35S14 GD	07/2007 -				CB 110 RST (B01)
DAILY III Pianale piatto/Telaio 35C14, 35C14 /P, 35S14, 35S14 /P, 35S14 D, 35S14 D/P	07/2007 -				CB 110 RST (B01)
DAILY III Pianale piatto/Telaio 35C15	05/2006 -				CB 110 RST (B01)
DAILY III Pianale piatto/Telaio 35C17, 35C17 /P, 35S17, 35S17 /P, 35S17 D	07/2007 -				CB 110 RST (B01)
DAILY III Pianale piatto/Telaio 35C18, 35S18	05/2006 -				CB 110 RST (B01)
DAILY III Pianale piatto/Telaio 35S14	05/2006 -				CB 110 RST (B01)
DAILY III Pianale piatto/Telaio 35S17 W, 35S17 WD	07/2007 -				CB 110 RST (B01)
DAILY III Pianale piatto/Telaio 40C10, 40S10	05/2006 -				CB 110 RST (B01)
DAILY III Pianale piatto/Telaio 40C11, 40C11 D, 40S11, 40S11 D	07/2007 -				CB 110 RST (B01)
DAILY III Pianale piatto/Telaio 40C12	05/2006 -				CB 110 RST (B01)
DAILY III Pianale piatto/Telaio 40C13, 40C13 /P, 40S13 D, 40S13, 40S13 /P	07/2007 -				CB 110 RST (B01)

MARCHIO E MODELLO - MAKE AND MODEL MARQUE ET MODÈLE - MARKE UND MODELL MARCA Y MODELO - МАРКА И МОДЕЛЬ	Periodo Period	powerCUBE		energyCUBE	
		APC	EHD	APC	RST
IVECO cont.					
DAILY III Pianale piatto/Telaio 40C14 G, 40C14 G/P, 40S14 G, 40S14 G/P, 40C14 GD, 40S14 GD	07/2007 -				CB 110 RST (B01)
DAILY III Pianale piatto/Telaio 40C14, 40C14 /P, 40S14, 40S14 /P, 40S14 D, 40S14 D/P	07/2007 -				CB 110 RST (B01)
DAILY III Pianale piatto/Telaio 40C15	05/2006 -				CB 110 RST (B01)
DAILY III Pianale piatto/Telaio 40C17, 40C17 /P, 40S17, 40S17 /P, 40S17 D	07/2007 -				CB 110 RST (B01)
DAILY III Pianale piatto/Telaio 40C18	05/2006 -				CB 110 RST (B01)
DAILY III Pianale piatto/Telaio 45C14, 45C14 /P	07/2007 -				CB 110 RST (B01)
DAILY III Pianale piatto/Telaio 45C15	05/2006 -				CB 110 RST (B01)
DAILY III Pianale piatto/Telaio 45C17, 45C17 /P	07/2007 -				CB 110 RST (B01)
DAILY III Pianale piatto/Telaio 45C18, 45C18 /P, 45C18 D, 45C18 D/P	05/2006 -				CB 110 RST (B01)
DAILY III Pianale piatto/Telaio 50C14 G, 50C14 G/P, 50C14 GD, 50C14 GD/P	07/2007 -				CB 110 RST (B01)
DAILY III Pianale piatto/Telaio 50C14, 50C14 /P	07/2007 -				CB 110 RST (B01)
DAILY III Pianale piatto/Telaio 50C15	05/2006 -				CB 110 RST (B01)
DAILY III Pianale piatto/Telaio 50C17, 50C17 /P	07/2007 -				CB 110 RST (B01)
DAILY III Pianale piatto/Telaio 50C18	05/2006 -				CB 110 RST (B01)
DAILY III Pianale piatto/Telaio 55S17 W, 55S17 WD	07/2007 -				CB 110 RST (B01)
DAILY III Pianale piatto/Telaio 60C14, 60C14 /P	07/2007 -				CB 110 RST (B01)
DAILY III Pianale piatto/Telaio 60C15, 60C15 /P, 60C15 D, 60C15 D/P	05/2006 -				CB 110 RST (B01)
DAILY III Pianale piatto/Telaio 60C17, 60C17 /P	07/2007 -				CB 110 RST (B01)
DAILY III Pianale piatto/Telaio 60C18	05/2006 -				CB 110 RST (B01)
DAILY III Pianale piatto/Telaio 65C14 G, 65C14 G/P, 65C14 GD, 65C14 GD/P	07/2007 -				CB 110 RST (B01)
DAILY III Pianale piatto/Telaio 65C14, 65C14 /P	07/2007 -				CB 110 RST (B01)
DAILY III Pianale piatto/Telaio 65C15, 65C15 /P, 65C15 D, 65C15 D/P	05/2006 -				CB 110 RST (B01)
DAILY III Pianale piatto/Telaio 65C17, 65C17 /P	07/2007 -				CB 110 RST (B01)
DAILY III Pianale piatto/Telaio 65C18	05/2006 -				CB 110 RST (B01)
DAILY III Pianale piatto/Telaio 70C14, 70C14 /P	07/2007 -				CB 110 RST (B01)
DAILY III Pianale piatto/Telaio 70C15	07/2007 -				CB 110 RST (B01)
DAILY III Pianale piatto/Telaio 70C17, 70C17 /P	07/2007 -				CB 110 RST (B01)
DAILY III Ribaltabile 35C10 K	05/2006 -				CB 110 RST (B01)
DAILY III Ribaltabile 35C11 K, 35C11 DK, 35S11 K, 35S11 DK	07/2007 -				CB 110 RST (B01)
DAILY III Ribaltabile 35C12	05/2006 -				CB 110 RST (B01)
DAILY III Ribaltabile 35C13 K, 35C13 DK, 35S13 K, 35S13 DK	07/2007 -				CB 110 RST (B01)
DAILY III Ribaltabile 35C14 K, 35C14 DK, 35S14 K, 35S14 DK	07/2007 -				CB 110 RST (B01)
DAILY III Ribaltabile 35C15	05/2006 -				CB 110 RST (B01)
DAILY III Ribaltabile 35C17 K, 35C17 DK, 35S17 K, 35S17 DK	07/2007 -				CB 110 RST (B01)
DAILY III Ribaltabile 35C18	05/2006 -				CB 110 RST (B01)
DAILY III Ribaltabile 35S14 K, 35S14 DK	07/2007 -				CB 110 RST (B01)
DAILY III Ribaltabile 40C14 K, 40C14 DK, 40S14 K, 40S14 DK	07/2007 -				CB 110 RST (B01)
DAILY III Ribaltabile 40C17 K, 40C17 DK	07/2007 -				CB 110 RST (B01)
DAILY III Ribaltabile 50C14 K, 50C14 DK	07/2007 -				CB 110 RST (B01)
DAILY III Ribaltabile 50C15	05/2006 -				CB 110 RST (B01)

MARCHIO E MODELLO - <i>MAKE AND MODEL</i> MARQUE ET MODÈLE - <i>MARKE UND MODELL</i> MARCA Y MODELO - <i>МАРКА И МОДЕЛЬ</i>	Periodo <i>Period</i>	powerCUBE		energyCUBE	
		APC	EHD	APC	RST
IVECO <i>cont.</i>					
DAILY III Ribaltabile 50C17 K, 50C17 DK	07/2007 -				CB 110 RST (B01)
DAILY III Ribaltabile 50C18	05/2006 -				CB 110 RST (B01)
DAILY III Ribaltabile 60C14 K, 60C14 DK	07/2007 -				CB 110 RST (B01)
DAILY III Ribaltabile 60C15	05/2006 -				CB 110 RST (B01)
DAILY III Ribaltabile 60C17 K, 60C17 DK	07/2007 -				CB 110 RST (B01)
DAILY III Ribaltabile 60C18	05/2006 -				CB 110 RST (B01)
DAILY III Ribaltabile 65C14 K, 65C14 DK	07/2007 -				CB 110 RST (B01)
DAILY III Ribaltabile 65C17 K, 65C17 DK, 65C17KK	07/2007 -				CB 110 RST (B01)
DAILY III Ribaltabile 70C14 K, 70C14 DK, 70C14 KK	07/2007 -				CB 110 RST (B01)
DAILY III Ribaltabile 70C17 K, 70C17 DK, 70C17 KK	07/2007 -				CB 110 RST (B01)
DAILY V Cassone / Furgonato / Promiscuo 29L11 V, 35C11 V, 35S11 V, 40C11 V	09/2011 -				CB 110 RST (B01)
DAILY V Cassone / Furgonato / Promiscuo 29L13 V, 35C13 V, 35S13 V, 40C13 V, 40S13 V	09/2011 -				CB 110 RST (B01)
DAILY V Cassone / Furgonato / Promiscuo 29L15 V, 35C15L V, 40C15L V, 50C15L V	09/2011 -				CB 110 RST (B01)
DAILY V Cassone / Furgonato / Promiscuo 3.0 35 S 14	04/2012 -				CB 110 RST (B01)
DAILY V Cassone / Furgonato / Promiscuo 35C15 V, 40C15 V	09/2011 -				CB 110 RST (B01)
DAILY V Cassone / Furgonato / Promiscuo 35C17 SV	09/2011 -				CB 110 RST (B01)
DAILY V Cassone / Furgonato / Promiscuo 35C21 V, 35S21 V, 40C21 V, 45C21 V, 50C21 V	09/2011 -				CB 110 RST (B01)
DAILY V Pianale piatto/Telaio 26L11, 26L11D, 35C11D, 35S11, 40C11	09/2011 -				CB 110 RST (B01)
DAILY V Pianale piatto/Telaio 29L13, 29L13D, 35C13D, 40C13	09/2011 -				CB 110 RST (B01)
DAILY V Pianale piatto/Telaio 35C15, 35C15D, 35S15, 40C15, 45C15, 50C15, 60C15, 70C15	09/2011 -				CB 110 RST (B01)
DAILY V Pianale piatto/Telaio 35C17, 35C17D, 35S17, 40C17, 45C17, 50C17, 60C17, 70C17	09/2011 -				CB 110 RST (B01)
DAILY V Pianale piatto/Telaio 35C21, 35S21, 40C21, 45C21, 50C21, 60C21, 70C21	09/2011 -				CB 110 RST (B01)
DAILY V Ribaltabile 35C11K, 35S11DKP	09/2011 -				CB 110 RST (B01)
DAILY V Ribaltabile 35C13K, 35C13DKP	09/2011 -				CB 110 RST (B01)
DAILY V Ribaltabile 35C15K, 35S15DKP, 50C15K, 60C15K, 65C15DK, 70C15K	09/2011 -				CB 110 RST (B01)
DAILY V Ribaltabile 35C17K, 35S17DKP, 50C17K, 65C17DK 70C17K	09/2011 -				CB 110 RST (B01)
DAILY V Ribaltabile 35S21DKP	09/2011 -				CB 110 RST (B01)
EuroCargo 100 E 15	01/1991 -				CB 110 RST (B01)
EuroCargo 100 E 15 K	01/1991 -				CB 110 RST (B01)
EuroCargo 100 E 17 K tector	09/2000 -				CB 110 RST (B01)
EuroCargo 100 E 17 tector	09/2000 -				CB 110 RST (B01)
EuroCargo 100 E 18	01/1991 -				CB 110 RST (B01)
EuroCargo 100 E 18 K	01/1991 -				CB 110 RST (B01)
EuroCargo 100 E 18 K tector	09/2000 -				CB 110 RST (B01)
EuroCargo 100 E 18 K tector	09/2006 -				CB 110 RST (B01)
EuroCargo 100 E 18 tector	09/2000 -				CB 110 RST (B01)
EuroCargo 100 E 18 tector, 100 E 18 P tector, 100 E 18 FP tector	09/2006 -				CB 110 RST (B01)

MARCHIO E MODELLO - MAKE AND MODEL MARQUE ET MODÈLE - MARKE UND MODELL MARCA Y MODELO - МАРКА И МОДЕЛЬ	Periodo Period	powerCUBE		energyCUBE	
		APC	EHD	APC	RST
IVECO cont.					
EuroCargo 100 E 18 W tector	09/2000 -				CB 110 RST (B01)
EuroCargo 100 E 21	01/1991 -				CB 110 RST (B01)
EuroCargo 100 E 21 K tector	09/2000 -				CB 110 RST (B01)
EuroCargo 100 E 21 tector	09/2000 -				CB 110 RST (B01)
EuroCargo 100 E 21 W tector	09/2000 -				CB 110 RST (B01)
EuroCargo 100 E 22 K tector	09/2006 -				CB 110 RST (B01)
EuroCargo 100 E 22 W tector, 100 E 22 WS tector	09/2006 -				CB 110 RST (B01)
EuroCargo 110 E 18 tector, 110 E 18 P tector, 110 EL 18 P tector	09/2006 -				CB 110 RST (B01)
EuroCargo 110 E 22 tector, 110 E 22 P tector, 110 EL 22 P tector	09/2006 -				CB 110 RST (B01)
EuroCargo 110 E 22 W tector	05/2006 -				CB 110 RST (B01)
EuroCargo 110 E 22 WS tector	05/2006 -				CB 110 RST (B01)
EuroCargo 110 E 25 W tector	05/2006 -				CB 110 RST (B01)
EuroCargo 110 E 25 WS tector	05/2006 -				CB 110 RST (B01)
EuroCargo 120 E 15	01/1991 -				CB 110 RST (B01)
EuroCargo 120 E 15 K	01/1992 -				CB 110 RST (B01)
EuroCargo 120 E 18	01/1992 -				CB 110 RST (B01)
EuroCargo 120 E 18 K	01/1992 -				CB 110 RST (B01)
EuroCargo 120 E 18 K tector	09/2000 -				CB 110 RST (B01)
EuroCargo 120 E 18 K tector	09/2006 -				CB 110 RST (B01)
EuroCargo 120 E 18 tector	09/2000 -				CB 110 RST (B01)
EuroCargo 120 E 21 H	01/1992 -	A 135 APC	A 140 EHD		
EuroCargo 120 E 21 K tector	09/2000 -				CB 110 RST (B01)
EuroCargo 120 E 21 tector, 120 E 21 P tector, 120 E 21 FP tector	09/2000 -				CB 110 RST (B01)
EuroCargo 120 E 22 K tector	09/2006 -				CB 110 RST (B01)
EuroCargo 120 E 22 P tector, 120 E 22 FP tector	09/2006 -				CB 110 RST (B01)
EuroCargo 120 E 23	01/1992 -				CB 110 RST (B01)
EuroCargo 120 E 24 K tector	09/2000 -				CB 110 RST (B01)
EuroCargo 120 E 24 tector	09/2000 -				CB 110 RST (B01)
EuroCargo 120 E 25 K tector	09/2006 -				CB 110 RST (B01)
EuroCargo 120 E 28 tector	09/2000 -				CB 110 RST (B01)
EuroCargo 120 E28 K tector	09/2000 -				CB 110 RST (B01)
EuroCargo 120 EL 17 tector	09/2000 -				CB 110 RST (B01)
EuroCargo 120 EL 21 tector	09/2000 -				CB 110 RST (B01)
EuroCargo 130 E 15	01/1994 -				CB 110 RST (B01)
EuroCargo 130 E 15 K	01/1994 -				CB 110 RST (B01)
EuroCargo 130 E 18	01/1992 -				CB 110 RST (B01)
EuroCargo 130 E 18 D tector, 130 E 18 DP tector	09/2006 -				CB 110 RST (B01)
EuroCargo 130 E 18 K	01/1992 -				CB 110 RST (B01)
EuroCargo 130 E 18 K tector	09/2000 -				CB 110 RST (B01)
EuroCargo 130 E 18 tector	09/2000 -				CB 110 RST (B01)
EuroCargo 130 E 21 K tector	09/2000 -				CB 110 RST (B01)
EuroCargo 130 E 21 tector, 130 E21 P tector, 130 E 21 FP tector	09/2000 -				CB 110 RST (B01)
EuroCargo 130 E 23	01/1992 -				CB 110 RST (B01)
EuroCargo 130 E 24 K tector	09/2000 -				CB 110 RST (B01)
EuroCargo 130 E 24 tector	09/2000 -				CB 110 RST (B01)

MARCHIO E MODELLO - MAKE AND MODEL MARQUE ET MODÈLE - MARKE UND MODELL MARCA Y MODELO - МАРКА И МОДЕЛЬ	Periodo Period	powerCUBE		energyCUBE	
		APC	EHD	APC	RST
IVECO					
cont.					
EuroCargo 130 E 25 D tector, 130 E 25 DP tector	09/2006 -				CB 110 RST (B01)
EuroCargo 130 E 25 DK tector	09/2006 -				CB 110 RST (B01)
EuroCargo 130 E 28 K tector	09/2000 -				CB 110 RST (B01)
EuroCargo 130 E 28 tector	09/2000 -				CB 110 RST (B01)
EuroCargo 135 E 18 W	01/1997 -				CB 110 RST (B01)
EuroCargo 135 E 18 WR	01/1993 - 12/1996				CB 110 RST (B01)
EuroCargo 135 E 21 W	01/1991 -	A 135 APC	A 140 EHD		
EuroCargo 135 E 23 W	01/1997 -				CB 110 RST (B01)
EuroCargo 135 E 23 WR	01/1993 - 12/1996				CB 110 RST (B01)
EuroCargo 140 E 18 K	05/2005 -				CB 110 RST (B01)
EuroCargo 140 E 18 K tector, 140 E 18 DK tector	09/2006 -				CB 110 RST (B01)
EuroCargo 140 E 18 tector, 140 E 18 P tector, 140 E 18 FP tector	09/2006 -				CB 110 RST (B01)
EuroCargo 140 E 18 W tector	09/2000 -				CB 110 RST (B01)
EuroCargo 140 E 18, 140 E 18 P, 140 E 18 FP	05/2005 -				CB 110 RST (B01)
EuroCargo 140 E 21 K	05/2005 -				CB 110 RST (B01)
EuroCargo 140 E 21 P, 140 E 21 FP	05/2005 -				CB 110 RST (B01)
EuroCargo 140 E 21 W tector	09/2000 -				CB 110 RST (B01)
EuroCargo 140 E 22 K tector	09/2006 -				CB 110 RST (B01)
EuroCargo 140 E 22 tector, 140 E 22 P tector, 140 E 22 FP tector	09/2006 -				CB 110 RST (B01)
EuroCargo 140 E 24 K tector	09/2000 -				CB 110 RST (B01)
EuroCargo 140 E 24 tector, 140 E 24 P tector, 140 E 24 FP tector	09/2000 -				CB 110 RST (B01)
EuroCargo 140 E 25 K tector, 140 E 25 DK tector	09/2006 -				CB 110 RST (B01)
EuroCargo 140 E 25 tector, 140 E 25 P tector, 140 E 25 FP tector	09/2006 -				CB 110 RST (B01)
EuroCargo 140 E 25 W tector, 140 E 25 WS tector	09/2006 -				CB 110 RST (B01)
EuroCargo 140 E 28 E W tector, 140 E 28 WS tector	09/2006 -				CB 110 RST (B01)
EuroCargo 140 E 28 K tector	09/2006 -				CB 110 RST (B01)
EuroCargo 140 E 28 tector, 140 E 28 P tector, 140 E 28 FP tector	09/2006 -				CB 110 RST (B01)
EuroCargo 150 E 15	01/1992 - 12/1996				CB 110 RST (B01)
EuroCargo 150 E 15 K	01/1992 - 12/1996				CB 110 RST (B01)
EuroCargo 150 E 18	01/1992 -				CB 110 RST (B01)
EuroCargo 150 E 18 K	01/1992 -				CB 110 RST (B01)
EuroCargo 150 E 18 K tector	09/2000 -				CB 110 RST (B01)
EuroCargo 150 E 18 K tector	09/2006 -				CB 110 RST (B01)
EuroCargo 150 E 18 tector	09/2000 -				CB 110 RST (B01)
EuroCargo 150 E 18 tector, 150 E 18 P tector, 150 E 18 FP tector	09/2006 -				CB 110 RST (B01)
EuroCargo 150 E 21 K tector	09/2000 -				CB 110 RST (B01)
EuroCargo 150 E 21 tector, 150 E 21 P tector, 150 E 21 FP tector	09/2000 -				CB 110 RST (B01)
EuroCargo 150 E 22 K tector	09/2006 -				CB 110 RST (B01)
EuroCargo 150 E 22 tector, 150 E 22 P tector, 150 E 22 FP tector	09/2006 -				CB 110 RST (B01)
EuroCargo 150 E 23	01/1992 -				CB 110 RST (B01)
EuroCargo 150 E 24 K tector	09/2000 -				CB 110 RST (B01)
EuroCargo 150 E 24 tector	09/2000 -				CB 110 RST (B01)
EuroCargo 150 E 25 K tector	09/2006 -				CB 110 RST (B01)
EuroCargo 150 E 25 W tector	09/2006 -				CB 110 RST (B01)
EuroCargo 150 E 25 WS tector	09/2006 -	B 180 APC	B 180 EHD	B 185 APC	

MARCHIO E MODELLO - MAKE AND MODEL MARQUE ET MODÈLE - MARKE UND MODELL MARCA Y MODELO - МАРКА И МОДЕЛЬ	Periodo Period	powerCUBE		energyCUBE	
		APC	EHD	APC	RST
IVECO					
cont.					
EuroCargo 150 E 27 R	01/1992 -				CB 110 RST (B01)
EuroCargo 150 E 28 K tector	09/2000 -				CB 110 RST (B01)
EuroCargo 150 E 28 tector	09/2000 -				CB 110 RST (B01)
EuroCargo 150 E 28 W tector	09/2006 -				CB 110 RST (B01)
EuroCargo 150 E 28 WS tector	09/2006 -	B 180 APC	B 180 EHD	B 185 APC	
EuroCargo 150 E 30 K tector	09/2006 -				CB 110 RST (B01)
EuroCargo 150 E 30 tector, 150 E 30 P tector, 150 E 30 FP tector	09/2006 -				CB 110 RST (B01)
EuroCargo 160 E 18 K tector	09/2006 -				CB 110 RST (B01)
EuroCargo 160 E 18 tector, 160 E 18 P tector	09/2006 -				CB 110 RST (B01)
EuroCargo 160 E 21 P tector	09/2000 -				CB 110 RST (B01)
EuroCargo 160 E 22 K tector	09/2006 -				CB 110 RST (B01)
EuroCargo 160 E 22 tector, 160 E 22 P tector	09/2006 -				CB 110 RST (B01)
EuroCargo 160 E 24 tector, 160 E 24 P tector	09/2000 -				CB 110 RST (B01)
EuroCargo 160 E 25 K tector	09/2006 -				CB 110 RST (B01)
EuroCargo 160 E 25 tector, 160 E 25 P tector	09/2006 -				CB 110 RST (B01)
EuroCargo 160 E 28 K tector	09/2006 -				CB 110 RST (B01)
EuroCargo 160 E 28 tector, 160 E 28 P tector	09/2000 -				CB 110 RST (B01)
EuroCargo 160 E 30 K tector	09/2006 -				CB 110 RST (B01)
EuroCargo 160 E 30 tector, 160 E 30 P tector	09/2006 -				CB 110 RST (B01)
EuroCargo 170 E 15	12/1991 - 07/2000	A 135 APC	A 140 EHD		
EuroCargo 170 E 18 K,180 E 18 K	01/1994 -				CB 110 RST (B01)
EuroCargo 170 E 18,180 E 18	01/1994 -				CB 110 RST (B01)
EuroCargo 170 E 23 K,180 E 23 K	01/1994 -				CB 110 RST (B01)
EuroCargo 170 E 23,180 E 23	01/1994 -				CB 110 RST (B01)
EuroCargo 170 E 27,180 E 27	01/1994 -				CB 110 RST (B01)
EuroCargo 180 E 21 K tector	09/2000 -				CB 110 RST (B01)
EuroCargo 180 E 21 T	01/1991 -				CB 110 RST (B01)
EuroCargo 180 E 21 tector	09/2000 -				CB 110 RST (B01)
EuroCargo 180 E 22 tector, 160 E 22 P tector	09/2006 -				CB 110 RST (B01)
EuroCargo 180 E 24 K tector	09/2000 -				CB 110 RST (B01)
EuroCargo 180 E 24 tector	09/2000 -				CB 110 RST (B01)
EuroCargo 180 E 25 K tector	09/2006 -				CB 110 RST (B01)
EuroCargo 180 E 28 K tector	09/2000 -				CB 110 RST (B01)
EuroCargo 180 E 28 tector	09/2000 -				CB 110 RST (B01)
EuroCargo 180 E 30 K tector	09/2006 -				CB 110 RST (B01)
EuroCargo 180 E 30 tector, 180 E 30 P tector	08/2006 -				CB 110 RST (B01)
EuroCargo 190 E 25 tector, 190 E 25 P tector	05/2008 -				CB 110 RST (B01)
EuroCargo 190 E 28 tector, 190 E 28 P tector	05/2008 -				CB 110 RST (B01)
EuroCargo 190 E 30 tector, 190 E 30 P tector	05/2008 -				CB 110 RST (B01)
EuroCargo 225 E 28 tector	09/2006 -	B 180 APC	B 180 EHD / B 160 EHD	B 185 APC	
EuroCargo 230 E 25 tector	05/2009 -	B 180 APC	B 180 EHD / B 160 EHD	B 185 APC	
EuroCargo 230 E 28 tector	09/2006 -	B 180 APC	B 180 EHD / B 160 EHD	B 185 APC	
EuroCargo 230 E 30 tector	02/2008 -	B 180 APC	B 180 EHD / B 160 EHD	B 185 APC	
EuroCargo 260 E 23		B 180 APC	B 180 EHD / B 160 EHD	B 185 APC	
EuroCargo 260 E 23 KE		B 180 APC	B 180 EHD / B 160 EHD	B 185 APC	

MARCHIO E MODELLO - MAKE AND MODEL MARQUE ET MODÈLE - MARKE UND MODELL MARCA Y MODELO - МАРКА И МОДЕЛЬ	Periodo Period	powerCUBE		energyCUBE	
		APC	EHD	APC	RST
IVECO					
<i>cont.</i>					
EuroCargo 260 E 23 T	01/1992 -	B 180 APC	B 180 EHD / B 160 EHD	B 185 APC	
EuroCargo 260 E 27 KE		B 180 APC	B 180 EHD / B 160 EHD	B 185 APC	
EuroCargo 260 E 28 K tector, 260 E 28 KE tector		B 180 APC	B 180 EHD	B 185 APC	
EuroCargo 280 E 23		B 180 APC	B 180 EHD / B 160 EHD	B 185 APC	
EuroCargo 280 E 23 T	01/1992 -	B 180 APC	B 180 EHD / B 160 EHD	B 185 APC	
EuroCargo 320 E 27		B 180 APC	B 180 EHD / B 160 EHD	B 185 APC	
EuroCargo 320 E 27 T	01/1992 -	B 180 APC	B 180 EHD / B 160 EHD	B 185 APC	
EuroCargo 320 E 28 T tector		B 180 APC	B 180 EHD	B 185 APC	
EuroCargo 320 E 28 T tector	09/2000 -	B 180 APC	B 180 EHD / B 160 EHD	B 185 APC	
EuroCargo 320 E 28 tector		B 180 APC	B 180 EHD / B 160 EHD	B 185 APC	
EuroCargo 60 E 10	01/1991 - 08/1996				CB 110 RST (B01)
EuroCargo 60 E 12	01/1991 - 12/1996				CB 110 RST (B01)
EuroCargo 60 E 13 K tector	09/2000 -				CB 110 RST (B01)
EuroCargo 60 E 13 tector, 60 E 13 P tector	09/2000 -				CB 110 RST (B01)
EuroCargo 60 E 14	01/1991 - 12/1996				CB 110 RST (B01)
EuroCargo 60 E 14 K	01/1991 - 12/1996				CB 110 RST (B01)
EuroCargo 60 E 14 K tector	09/2006 -				CB 110 RST (B01)
EuroCargo 60 E 14 tector, 60 E 14 P tector	09/2006 -				CB 110 RST (B01)
EuroCargo 60 E 15 K tector	09/2000 -				CB 110 RST (B01)
EuroCargo 60 E 15 tector, 60 E 15 P tector	09/2000 -				CB 110 RST (B01)
EuroCargo 60 E 16 K tector	09/2006 -				CB 110 RST (B01)
EuroCargo 60 E 16 tector, 60 E 16 P tector	09/2006 -				CB 110 RST (B01)
EuroCargo 65 E 10	01/1991 - 12/1996				CB 110 RST (B01)
EuroCargo 65 E 10 K	01/1991 - 12/1996				CB 110 RST (B01)
EuroCargo 65 E 12	01/1991 - 12/2000				CB 110 RST (B01)
EuroCargo 65 E 12 K	01/1991 - 12/2000				CB 110 RST (B01)
EuroCargo 65 E 13 K tector	09/2000 -				CB 110 RST (B01)
EuroCargo 65 E 14	01/1991 - 12/2000				CB 110 RST (B01)
EuroCargo 65 E 14 K	01/1991 - 12/2000				CB 110 RST (B01)
EuroCargo 65 E 14 K tector	09/2006 -				CB 110 RST (B01)
EuroCargo 65 E 14 tector	09/2006 -				CB 110 RST (B01)
EuroCargo 65 E 15 tector	09/2000 -				CB 110 RST (B01)
EuroCargo 65 E 16 K tector	09/2006 -				CB 110 RST (B01)
EuroCargo 65 E 16 tector	09/2006 -				CB 110 RST (B01)
EuroCargo 65 E15	09/2000 -				CB 110 RST (B01)
EuroCargo 75 E 12	01/1991 - 12/2000				CB 110 RST (B01)
EuroCargo 75 E 12 K	01/1997 -				CB 110 RST (B01)
EuroCargo 75 E 13 K tector	09/2000 -				CB 110 RST (B01)
EuroCargo 75 E 13 tector	09/2000 -				CB 110 RST (B01)
EuroCargo 75 E 14	01/1991 -				CB 110 RST (B01)
EuroCargo 75 E 14 K	01/1997 -				CB 110 RST (B01)
EuroCargo 75 E 14 K tector	09/2006 -				CB 110 RST (B01)
EuroCargo 75 E 14 tector, 75 E 14 P tector	09/2006 -				CB 110 RST (B01)
EuroCargo 75 E 15 K	01/1991 - 09/2000				CB 110 RST (B01)
EuroCargo 75 E 15 K tector	09/2000 -				CB 110 RST (B01)

MARCHIO E MODELLO - MAKE AND MODEL MARQUE ET MODÈLE - MARKE UND MODELL MARCA Y MODELO - МАРКА И МОДЕЛЬ	Periodo Period	powerCUBE		energyCUBE	
		APC	EHD	APC	RST
IVECO cont.					
EuroCargo 75 E 15 tector	09/2000 -				CB 110 RST (B01)
EuroCargo 75 E 15,80 E 15	01/1991 - 09/2000				CB 110 RST (B01)
EuroCargo 75 E 16 K tector	09/2006 -				CB 110 RST (B01)
EuroCargo 75 E 16 tector	05/2006 -				CB 110 RST (B01)
EuroCargo 75 E 17 K tector	09/2000 -				CB 110 RST (B01)
EuroCargo 75 E 17 tector	09/2000 -				CB 110 RST (B01)
EuroCargo 75 E 18 K tector	09/2000 -				CB 110 RST (B01)
EuroCargo 75 E 18 tector	09/2000 -				CB 110 RST (B01)
EuroCargo 80 E 15	01/1991 -				CB 110 RST (B01)
EuroCargo 80 E 15 K	01/1991 -				CB 110 RST (B01)
EuroCargo 80 E 17 K	09/2000 -				CB 110 RST (B01)
EuroCargo 80 E 17 tector	09/2000 -				CB 110 RST (B01)
EuroCargo 80 E 18	01/1991 -				CB 110 RST (B01)
EuroCargo 80 E 18 K	01/1991 -				CB 110 RST (B01)
EuroCargo 80 E 18 K tector	09/2000 -				CB 110 RST (B01)
EuroCargo 80 E 18 K tector	09/2006 -				CB 110 RST (B01)
EuroCargo 80 E 18 tector	09/2000 -				CB 110 RST (B01)
EuroCargo 80 E 18 tector, 80 E 18 P tector, 80 E 18 FP tector	09/2006 -				CB 110 RST (B01)
EuroCargo 80 E 21	01/1991 -				CB 110 RST (B01)
EuroCargo 80 E 21 K tector	09/2000 -				CB 110 RST (B01)
EuroCargo 80 E 21 tector	09/2000 -				CB 110 RST (B01)
EuroCargo 80 EL 15 tector	09/2000 -				CB 110 RST (B01)
EuroCargo 80 EL 16 tector	05/2006 -				CB 110 RST (B01)
EuroCargo 80 EL 17 tector, 80 EL 17 P tector	09/2000 -				CB 110 RST (B01)
EuroCargo 80 EL 18 tector, 80 EL 18 P tector	09/2006 -				CB 110 RST (B01)
EuroCargo 90 E 17 K tector	09/2000 -				CB 110 RST (B01)
EuroCargo 90 E 17 tector	09/2000 -				CB 110 RST (B01)
EuroCargo 90 E 18 K tector	09/2000 -				CB 110 RST (B01)
EuroCargo 90 E 18 tector	09/2000 -				CB 110 RST (B01)
EuroCargo 90 E 21 K tector	09/2000 -				CB 110 RST (B01)
EuroCargo 90 E 21 tector	09/2000 -				CB 110 RST (B01)
EuroCargo 90 E 22 K tector	09/2006 -				CB 110 RST (B01)
EuroCargo 95 E 15 W	11/1993 -				CB 110 RST (B01)
EuroCargo 95 E 21 W	11/1993 -				CB 110 RST (B01)
EuroCargo tector 65 E 13	09/2000 -				CB 110 RST (B01)
EuroFire 100 E 21 tector	09/2000 -	A 135 APC	A 140 EHD		
EuroFire 100 E 25 W tector	05/2006 -	A 135 APC	A 140 EHD		
EuroFire 120 E 22 tector	09/2006 -	A 135 APC	A 140 EHD		
EuroFire 130 E 24	09/2006 -	A 135 APC	A 140 EHD		
EuroFire 130 E 24 tector	09/2000 -	A 135 APC	A 140 EHD		
EuroFire 135 E 22 W	09/2006 -	A 135 APC	A 140 EHD		
EuroFire 135 E 24 W	09/2006 -	A 135 APC	A 140 EHD		
EuroFire 140 E 24 tector	09/2000 -	A 135 APC	A 140 EHD		
EuroFire 140 E 25 tector	09/2006 -	A 135 APC	A 140 EHD		
EuroFire 140 E 28 tector	09/2006 -	A 135 APC	A 140 EHD		

MARCHIO E MODELLO - MAKE AND MODEL MARQUE ET MODÈLE - MARKE UND MODELL MARCA Y MODELO - МАРКА И МОДЕЛЬ	Periodo Period	powerCUBE		energyCUBE	
		APC	EHD	APC	RST
IVECO					
<small>cont.</small>					
EuroFire 140 E 30 W tector	09/2006 -	A 135 APC	A 140 EHD		
EuroFire 150 E 24 tector	09/2000 -	A 135 APC	A 140 EHD		
EuroFire 150 E 27		A 135 APC	A 140 EHD		
EuroFire 150 E 28 tector	09/2006 -	A 135 APC	A 140 EHD		
EuroFire 160 E 30 tector	09/2006 -	A 135 APC	A 140 EHD		
EuroFire 75 E 14	09/2006 -	A 135 APC	A 140 EHD		
EuroFire 75 E 15 tector	09/2000 -	A 135 APC	A 140 EHD		
EuroFire 80 E 18 tector	09/2006 -	A 135 APC	A 140 EHD		
EuroFire 95 E 18 W	09/2000 -	A 135 APC	A 140 EHD		
EuroStar LD 190 E 38 P	01/1993 - 02/2002	B 180 APC	B 180 EHD / B 160 EHD	B 185 APC	
EuroStar LD 190 E 39 P	11/1999 - 02/2002	B 180 APC	B 180 EHD / B 160 EHD	B 185 APC	
EuroStar LD 190 E 40	09/2000 - 02/2002	B 180 APC	B 180 EHD / B 160 EHD	B 185 APC	
EuroStar LD 190 E 42	01/1993 - 02/2002	B 180 APC	B 180 EHD / B 160 EHD	B 185 APC	
EuroStar LD 190 E 43 P	11/1999 - 02/2002	B 180 APC	B 180 EHD / B 160 EHD	B 185 APC	
EuroStar LD 190 E 47	01/1993 - 02/2002	B 180 APC	B 180 EHD / B 160 EHD	B 185 APC	
EuroStar LD 190 E 52	01/1993 - 02/2002	B 180 APC	B 180 EHD / B 160 EHD	B 185 APC	
EuroStar LD 240 E 38	01/1993 - 02/2002	B 180 APC	B 180 EHD / B 160 EHD	B 185 APC	
EuroStar LD 240 E 42	01/1993 - 02/2002	B 180 APC	B 180 EHD / B 160 EHD	B 185 APC	
EuroStar LD 240 E 47 P	01/1993 - 02/2002	B 180 APC	B 180 EHD / B 160 EHD	B 185 APC	
EuroStar LD 240 E 52 P	01/1993 - 02/2002	B 180 APC	B 180 EHD / B 160 EHD	B 185 APC	
EuroStar LD 260 E 38 P	01/1993 - 02/2002	B 180 APC	B 180 EHD / B 160 EHD	B 185 APC	
EuroStar LD 260 E 39 P	11/1999 - 02/2002	B 180 APC	B 180 EHD / B 160 EHD	B 185 APC	
EuroStar LD 260 E 40	09/2000 - 02/2002	B 180 APC	B 180 EHD / B 160 EHD	B 185 APC	
EuroStar LD 260 E 42 P	01/1993 - 02/2002	B 180 APC	B 180 EHD / B 160 EHD	B 185 APC	
EuroStar LD 260 E 43 Y/PS	01/1993 - 02/2002	B 180 APC	B 180 EHD / B 160 EHD	B 185 APC	
EuroStar LD 260 E 47	01/1993 - 02/2002	B 180 APC	B 180 EHD / B 160 EHD	B 185 APC	
EuroStar LD 260 E 48 Y/PS	01/1993 - 02/2002	B 180 APC	B 180 EHD / B 160 EHD	B 185 APC	
EuroStar LD 260 E 52	01/1993 - 02/2002	B 180 APC	B 180 EHD / B 160 EHD	B 185 APC	
EuroStar LD 400 E 38 TXP, LD 440 E 38 TXP	01/1993 - 02/2002	B 180 APC	B 180 EHD / B 160 EHD	B 185 APC	
EuroStar LD 400 E 42 TXP, LD 440 E 42 TXP	01/1993 - 02/2002	B 180 APC	B 180 EHD / B 160 EHD	B 185 APC	
EuroStar LD 440 E	01/2001 - 02/2002	B 180 APC	B 180 EHD / B 160 EHD	B 185 APC	
EuroStar LD 440 E 38 T	01/1993 - 02/2002	B 180 APC	B 180 EHD / B 160 EHD	B 185 APC	
EuroStar LD 440 E 38 TZ	01/1993 - 02/2002	B 180 APC	B 180 EHD / B 160 EHD	B 185 APC	
EuroStar LD 440 E 39 T	11/1999 - 02/2002	B 180 APC	B 180 EHD / B 160 EHD	B 185 APC	
EuroStar LD 440 E 39 TX, LD 440 E 39 TX/P	11/1999 -	B 180 APC	B 180 EHD / B 160 EHD	B 185 APC	
EuroStar LD 440 E 40 T	09/2000 - 02/2002	B 180 APC	B 180 EHD / B 160 EHD	B 185 APC	
EuroStar LD 440 E 42 T	01/1993 - 02/2002	B 180 APC	B 180 EHD / B 160 EHD	B 185 APC	
EuroStar LD 440 E 42 TZ	01/1993 - 02/2002	B 180 APC	B 180 EHD / B 160 EHD	B 185 APC	
EuroStar LD 440 E 43 TP	01/1993 - 02/2002	B 180 APC	B 180 EHD / B 160 EHD	B 185 APC	
EuroStar LD 440 E 43 TX/P	11/1999 - 02/2002	B 180 APC	B 180 EHD / B 160 EHD	B 185 APC	
EuroStar LD 440 E 47 T	01/1993 - 02/2002	B 180 APC	B 180 EHD / B 160 EHD	B 185 APC	
EuroStar LD 440 E 47 TZ	01/1993 - 02/2002	B 180 APC	B 180 EHD / B 160 EHD	B 185 APC	
EuroStar LD 440 E 48	01/2001 - 02/2002	B 180 APC	B 180 EHD / B 160 EHD	B 185 APC	
EuroStar LD 440 E 52 T	01/1993 - 02/2002	B 180 APC	B 180 EHD / B 160 EHD	B 185 APC	
EuroStar LD 440 E 52 TZ	01/1993 - 02/2002	B 180 APC	B 180 EHD / B 160 EHD	B 185 APC	

MARCHIO E MODELLO - MAKE AND MODEL MARQUE ET MODÈLE - MARKE UND MODELL MARCA Y MODELO - МАРКА И МОДЕЛЬ	Periodo Period	powerCUBE		energyCUBE	
		APC	EHD	APC	RST
IVECO cont.					
EuroTech MH 190 E 30, 190 E 30 /P	01/2000 -	B 180 APC	B 180 EHD / B 160 EHD	B 185 APC	
EuroTech MH 260 E 30 Y/PS	01/2000 -	B 180 APC	B 180 EHD / B 160 EHD	B 185 APC	
EuroTech MH 440 E 35 TX/P	02/2000 -	B 180 APC	B 180 EHD / B 160 EHD	B 185 APC	
EuroTech MH MH 190 E 24	09/1998 -	B 180 APC	B 180 EHD / B 160 EHD	B 185 APC	
EuroTech MH MH 190 E 24 K	09/1998 -	B 180 APC	B 180 EHD / B 160 EHD	B 185 APC	
EuroTech MH MH 190 E 27	09/1998 -	B 180 APC	B 180 EHD / B 160 EHD	B 185 APC	
EuroTech MH MH 190 E 27 K	09/1998 -	B 180 APC	B 180 EHD / B 160 EHD	B 185 APC	
EuroTech MH MH 190 E 31	09/1998 -	B 180 APC	B 180 EHD / B 160 EHD	B 185 APC	
EuroTech MH MH 190 E 31 K	09/1998 -	B 180 APC	B 180 EHD / B 160 EHD	B 185 APC	
EuroTech MH MH 190 E 35	09/1998 -	B 180 APC	B 180 EHD / B 160 EHD	B 185 APC	
EuroTech MH MH 260 E 24 Y/P	11/1999 -	B 180 APC	B 180 EHD / B 160 EHD	B 185 APC	
EuroTech MH MH 260 E 27 Y/P	11/1999 -	B 180 APC	B 180 EHD / B 160 EHD	B 185 APC	
EuroTech MH MH 260 E 31 Y/P	11/1999 -	B 180 APC	B 180 EHD / B 160 EHD	B 185 APC	
EuroTech MH MH 260 E 35 Y/P	11/1999 -	B 180 APC	B 180 EHD / B 160 EHD	B 185 APC	
EuroTech MH MH 400 E 31 TP,MH 440 E 31 TP	09/1998 -	B 180 APC	B 180 EHD / B 160 EHD	B 185 APC	
EuroTech MH MH 400 E 35 TP,MH 440 E 35 TP	09/1998 -	B 180 APC	B 180 EHD / B 160 EHD	B 185 APC	
EuroTech MP 190 E 40 /P	01/2001 -	B 180 APC	B 180 EHD / B 160 EHD	B 185 APC	
EuroTech MP 190 E 43	01/2001 -	B 180 APC	B 180 EHD / B 160 EHD	B 185 APC	
EuroTech MP 260 E 40 Y/P	01/2001 -	B 180 APC	B 180 EHD / B 160 EHD	B 185 APC	
EuroTech MP 440 E 40 T	09/2000 -	B 180 APC	B 180 EHD / B 160 EHD	B 185 APC	
EuroTech MP 440 E 40 TX/P	01/2001 -	B 180 APC	B 180 EHD / B 160 EHD	B 185 APC	
EuroTech MP 440 E 43 TX/P	11/1999 -	B 180 APC	B 180 EHD / B 160 EHD	B 185 APC	
EuroTech MP 4500	01/2002 -	B 180 APC	B 180 EHD	B 185 APC	
EuroTech MP MP 180 E 34	01/1992 - 12/1993	B 180 APC	B 180 EHD / B 160 EHD	B 185 APC	
EuroTech MP MP 180 E 38	01/1992 - 12/1993	B 180 APC	B 180 EHD / B 160 EHD	B 185 APC	
EuroTech MP MP 180 E 42	01/1992 - 12/1993	B 180 APC	B 180 EHD / B 160 EHD	B 185 APC	
EuroTech MP MP 190 E 34	01/1993 -	B 180 APC	B 180 EHD / B 160 EHD	B 185 APC	
EuroTech MP MP 190 E 38	01/1993 -	B 180 APC	B 180 EHD / B 160 EHD	B 185 APC	
EuroTech MP MP 190 E 39 FP-CT	11/1999 -	B 180 APC	B 180 EHD / B 160 EHD	B 185 APC	
EuroTech MP MP 190 E 42	01/1993 -	B 180 APC	B 180 EHD / B 160 EHD	B 185 APC	
EuroTech MP MP 240 E 30 PS	01/1997 -	B 180 APC	B 180 EHD / B 160 EHD	B 185 APC	
EuroTech MP MP 240 E 34	09/1995 - 12/1996	B 180 APC	B 180 EHD / B 160 EHD	B 185 APC	
EuroTech MP MP 240 E 38	01/1992 -	B 180 APC	B 180 EHD / B 160 EHD	B 185 APC	
EuroTech MP MP 240 E 42	01/1992 -	B 180 APC	B 180 EHD / B 160 EHD	B 185 APC	
EuroTech MP MP 260 E 38 P	01/1994 -	B 180 APC	B 180 EHD / B 160 EHD	B 185 APC	
EuroTech MP MP 260 E 39 Y/PS	11/1999 -	B 180 APC	B 180 EHD / B 160 EHD	B 185 APC	
EuroTech MP MP 260 E 42	01/1994 -	B 180 APC	B 180 EHD / B 160 EHD	B 185 APC	
EuroTech MP MP 260 E 43 Y/PS	11/1999 -	B 180 APC	B 180 EHD / B 160 EHD	B 185 APC	
EuroTech MP MP 400 E 34 T,MP 440 E 34 T	01/1992 -	B 180 APC	B 180 EHD / B 160 EHD	B 185 APC	
EuroTech MP MP 400 E 38 T,MP 440 E 38 T	01/1992 -	B 180 APC	B 180 EHD / B 160 EHD	B 185 APC	
EuroTech MP MP 400 E 38 TXP	11/1993 - 12/1996	B 180 APC	B 180 EHD / B 160 EHD	B 185 APC	
EuroTech MP MP 400 E 42 T,MP 440 E 42 T	01/1992 -	B 180 APC	B 180 EHD / B 160 EHD	B 185 APC	
EuroTech MP MP 440 E 38 TZ	01/1993 -	B 180 APC	B 180 EHD / B 160 EHD	B 185 APC	
EuroTech MP MP 440 E 39 TP	11/1999 -	B 180 APC	B 180 EHD / B 160 EHD	B 185 APC	
EuroTech MP MP 440 E 39 TX/P	11/1999 -	B 180 APC	B 180 EHD / B 160 EHD	B 185 APC	

MARCHIO E MODELLO - MAKE AND MODEL MARQUE ET MODÈLE - MARKE UND MODELL MARCA Y MODELO - МАРКА И МОДЕЛЬ	Periodo Period	powerCUBE		energyCUBE	
		APC	EHD	APC	RST
IVECO					
<i>cont.</i>					
EuroTech MP MP 440 E 42 TZ	01/1993 -	B 180 APC	B 180 EHD / B 160 EHD	B 185 APC	
EuroTech MP MP 440 E 43 TP	11/1999 -	B 180 APC	B 180 EHD / B 160 EHD	B 185 APC	
EuroTech MT MT 180 E 24	01/1992 - 12/1996	B 180 APC	B 180 EHD / B 160 EHD	B 185 APC	
EuroTech MT MT 180 E 24 K	01/1993 - 12/1996	B 180 APC	B 180 EHD / B 160 EHD	B 185 APC	
EuroTech MT MT 180 E 27	01/1992 - 12/1996	B 180 APC	B 180 EHD / B 160 EHD	B 185 APC	
EuroTech MT MT 180 E 27 K	01/1992 - 12/1996	B 180 APC	B 180 EHD / B 160 EHD	B 185 APC	
EuroTech MT MT 180 E 30 R	01/1992 - 12/1996	B 180 APC	B 180 EHD / B 160 EHD	B 185 APC	
EuroTech MT MT 180 E 34 R	01/1992 - 12/1993	B 180 APC	B 180 EHD / B 160 EHD	B 185 APC	
EuroTech MT MT 190 E 24	01/1997 - 08/1998	B 180 APC	B 180 EHD / B 160 EHD	B 185 APC	
EuroTech MT MT 190 E 24 K	01/1997 - 08/1998	B 180 APC	B 180 EHD / B 160 EHD	B 185 APC	
EuroTech MT MT 190 E 27	01/1997 - 08/1998	B 180 APC	B 180 EHD / B 160 EHD	B 185 APC	
EuroTech MT MT 190 E 27 K	01/1997 - 08/1998	B 180 APC	B 180 EHD / B 160 EHD	B 185 APC	
EuroTech MT MT 190 E 30	01/1997 - 08/1998	B 180 APC	B 180 EHD / B 160 EHD	B 185 APC	
EuroTech MT MT 190 E 30 K	01/1997 - 08/1998	B 180 APC	B 180 EHD / B 160 EHD	B 185 APC	
EuroTech MT MT 400 E 30 T	01/1992 - 08/1998	B 180 APC	B 180 EHD / B 160 EHD	B 185 APC	
EuroTech MT MT 400 E 34 T	01/1992 - 08/1998	B 180 APC	B 180 EHD / B 160 EHD	B 185 APC	
EuroTrakker MP 180 E 24 W Cursor	09/1999 - 11/2004	B 180 APC	B 180 EHD / B 160 EHD	B 185 APC	
EuroTrakker MP 180 E 25 W	05/1999 - 11/2004	B 180 APC	B 180 EHD	B 185 APC	
EuroTrakker MP 190	01/2001 - 11/2004	B 180 APC	B 180 EHD / B 160 EHD	B 185 APC	
EuroTrakker MP 190 E 24 H Cursor	09/1999 - 11/2004	B 180 APC	B 180 EHD / B 160 EHD	B 185 APC	
EuroTrakker MP 190 E 30 H	01/1993 - 11/2004	B 180 APC	B 180 EHD / B 160 EHD	B 185 APC	
EuroTrakker MP 190 E 30 W	01/1993 - 11/2004	B 180 APC	B 180 EHD / B 160 EHD	B 185 APC	
EuroTrakker MP 190 E 30 W	11/1999 - 11/2004	B 180 APC	B 180 EHD / B 160 EHD	B 185 APC	
EuroTrakker MP 190 E 31 H Cursor	09/1999 - 11/2004	B 180 APC	B 180 EHD / B 160 EHD	B 185 APC	
EuroTrakker MP 190 E 31 W Cursor	09/1999 - 11/2004	B 180 APC	B 180 EHD / B 160 EHD	B 185 APC	
EuroTrakker MP 190 E 34 H	01/1993 - 11/2004	B 180 APC	B 180 EHD / B 160 EHD	B 185 APC	
EuroTrakker MP 190 E 34 W	01/1993 - 11/2004	B 180 APC	B 180 EHD / B 160 EHD	B 185 APC	
EuroTrakker MP 190 E 34 W	11/1999 - 11/2004	B 180 APC	B 180 EHD / B 160 EHD	B 185 APC	
EuroTrakker MP 190 E 35 H Cursor	09/1999 - 11/2004	B 180 APC	B 180 EHD / B 160 EHD	B 185 APC	
EuroTrakker MP 190 E 35 W Cursor	09/1999 - 11/2004	B 180 APC	B 180 EHD / B 160 EHD	B 185 APC	
EuroTrakker MP 190 E 37 H	01/1993 - 11/2004	B 180 APC	B 180 EHD / B 160 EHD	B 185 APC	
EuroTrakker MP 190 E 37 H	01/2000 - 11/2004	B 180 APC	B 180 EHD / B 160 EHD	B 185 APC	
EuroTrakker MP 190 E 37 W	01/1993 - 11/2004	B 180 APC	B 180 EHD / B 160 EHD	B 185 APC	
EuroTrakker MP 190 E 37 W	11/1999 - 11/2004	B 180 APC	B 180 EHD / B 160 EHD	B 185 APC	
EuroTrakker MP 190 E 38 W	01/2001 - 11/2004	B 180 APC	B 180 EHD / B 160 EHD	B 185 APC	
EuroTrakker MP 190 E 42 H	01/1995 - 11/2004	B 180 APC	B 180 EHD / B 160 EHD	B 185 APC	
EuroTrakker MP 190 E 42 H	11/1999 - 11/2004	B 180 APC	B 180 EHD / B 160 EHD	B 185 APC	
EuroTrakker MP 190 E 42 W	01/1995 - 11/2004	B 180 APC	B 180 EHD / B 160 EHD	B 185 APC	
EuroTrakker MP 190 E 44 W Cursor	09/2000 - 11/2004	B 180 APC	B 180 EHD / B 160 EHD	B 185 APC	
EuroTrakker MP 190 E 47 W	11/1999 - 11/2004	B 180 APC	B 180 EHD / B 160 EHD	B 185 APC	
EuroTrakker MP 190 E 55 W Cursor	09/2000 - 11/2004	B 180 APC	B 180 EHD / B 160 EHD	B 185 APC	
EuroTrakker MP 260 E 27 H Cursor	11/1999 - 11/2004	B 180 APC	B 180 EHD	B 185 APC	
EuroTrakker MP 260 E 30 H	01/1993 - 11/2004	B 180 APC	B 180 EHD / B 160 EHD	B 185 APC	
EuroTrakker MP 260 E 30 W	11/1999 - 11/2004	B 180 APC	B 180 EHD / B 160 EHD	B 185 APC	
EuroTrakker MP 260 E 31 H Cursor	09/1999 - 11/2004	B 180 APC	B 180 EHD / B 160 EHD	B 185 APC	

MARCHIO E MODELLO - MAKE AND MODEL MARQUE ET MODÈLE - MARKE UND MODELL MARCA Y MODELO - МАРКА И МОДЕЛЬ	Periodo Period	powerCUBE		energyCUBE	
		APC	EHD	APC	RST
IVECO					
<i>cont.</i>					
EuroTrakker MP 260 E 31 HB Cursor	01/2001 - 11/2004	B 180 APC	B 180 EHD / B 160 EHD	B 185 APC	
EuroTrakker MP 260 E 34 H	01/1993 - 11/2004	B 180 APC	B 180 EHD / B 160 EHD	B 185 APC	
EuroTrakker MP 260 E 34 H	11/1999 - 11/2004	B 180 APC	B 180 EHD / B 160 EHD	B 185 APC	
EuroTrakker MP 260 E 34 W	01/1993 - 11/2004	B 180 APC	B 180 EHD / B 160 EHD	B 185 APC	
EuroTrakker MP 260 E 34 W	11/1999 - 11/2004	B 180 APC	B 180 EHD / B 160 EHD	B 185 APC	
EuroTrakker MP 260 E 35 H Cursor	01/2000 - 11/2004	B 180 APC	B 180 EHD / B 160 EHD	B 185 APC	
EuroTrakker MP 260 E 35 W Cursor	09/1999 - 11/2004	B 180 APC	B 180 EHD / B 160 EHD	B 185 APC	
EuroTrakker MP 260 E 37 H	01/1993 - 11/2004	B 180 APC	B 180 EHD / B 160 EHD	B 185 APC	
EuroTrakker MP 260 E 37 W	01/1993 - 11/2004	B 180 APC	B 180 EHD / B 160 EHD	B 185 APC	
EuroTrakker MP 260 E 37 W	11/1999 - 11/2004	B 180 APC	B 180 EHD / B 160 EHD	B 185 APC	
EuroTrakker MP 260 E 38 H Cursor	01/2001 - 11/2004	B 180 APC	B 180 EHD / B 160 EHD	B 185 APC	
EuroTrakker MP 260 E 38 W Cursor	01/2001 - 11/2004	B 180 APC	B 180 EHD / B 160 EHD	B 185 APC	
EuroTrakker MP 260 E 42 H	01/1993 - 11/2004	B 180 APC	B 180 EHD / B 160 EHD	B 185 APC	
EuroTrakker MP 260 E 42 H	11/1999 - 11/2004	B 180 APC	B 180 EHD / B 160 EHD	B 185 APC	
EuroTrakker MP 260 E 42 W	01/1993 - 11/2004	B 180 APC	B 180 EHD / B 160 EHD	B 185 APC	
EuroTrakker MP 260 E 44 H Cursor	01/2000 - 11/2004	B 180 APC	B 180 EHD / B 160 EHD	B 185 APC	
EuroTrakker MP 260 E 44 H Cursor	01/2001 - 11/2004	B 180 APC	B 180 EHD / B 160 EHD	B 185 APC	
EuroTrakker MP 260 E 44 W Cursor	01/2001 - 11/2004	B 180 APC	B 180 EHD / B 160 EHD	B 185 APC	
EuroTrakker MP 260 E 47 H	11/1999 - 11/2004	B 180 APC	B 180 EHD / B 160 EHD	B 185 APC	
EuroTrakker MP 260 E 47 W	11/1999 - 11/2004	B 180 APC	B 180 EHD / B 160 EHD	B 185 APC	
EuroTrakker MP 260 E35 H Cursor	01/2000 - 11/2004	B 180 APC	B 180 EHD / B 160 EHD	B 185 APC	
EuroTrakker MP 340 E 34 H	01/1994 - 11/2004	B 180 APC	B 180 EHD / B 160 EHD	B 185 APC	
EuroTrakker MP 340 E 34 H	11/1999 - 11/2004	B 180 APC	B 180 EHD / B 160 EHD	B 185 APC	
EuroTrakker MP 340 E 35 H Cursor	09/1999 - 11/2004	B 180 APC	B 180 EHD / B 160 EHD	B 185 APC	
EuroTrakker MP 340 E 35 HB Cursor	01/2001 - 11/2004	B 180 APC	B 180 EHD / B 160 EHD	B 185 APC	
EuroTrakker MP 340 E 37 H	01/1994 - 11/2004	B 180 APC	B 180 EHD / B 160 EHD	B 185 APC	
EuroTrakker MP 340 E 37 H	11/1999 - 11/2004	B 180 APC	B 180 EHD / B 160 EHD	B 185 APC	
EuroTrakker MP 340 E 38 H Cursor	01/2001 - 11/2004	B 180 APC	B 180 EHD / B 160 EHD	B 185 APC	
EuroTrakker MP 340 E 38 HB Cursor	01/2001 - 11/2004	B 180 APC	B 180 EHD / B 160 EHD	B 185 APC	
EuroTrakker MP 340 E 42 H	01/1995 - 11/2004	B 180 APC	B 180 EHD / B 160 EHD	B 185 APC	
EuroTrakker MP 340 E 42 H	11/1999 - 11/2004	B 180 APC	B 180 EHD / B 160 EHD	B 185 APC	
EuroTrakker MP 340 E 44 Cursor	01/2001 - 11/2004	B 180 APC	B 180 EHD / B 160 EHD	B 185 APC	
EuroTrakker MP 340 E 44 H Cursor	01/2001 - 11/2004	B 180 APC	B 180 EHD / B 160 EHD	B 185 APC	
EuroTrakker MP 340 E 44 HB Cursor	01/2001 - 11/2004	B 180 APC	B 180 EHD / B 160 EHD	B 185 APC	
EuroTrakker MP 380 E 34 H	01/1993 - 11/2004	B 180 APC	B 180 EHD / B 160 EHD	B 185 APC	
EuroTrakker MP 380 E 34 H	11/1999 - 11/2004	B 180 APC	B 180 EHD / B 160 EHD	B 185 APC	
EuroTrakker MP 380 E 34 W	11/1999 - 11/2004	B 180 APC	B 180 EHD / B 160 EHD	B 185 APC	
EuroTrakker MP 380 E 35 H Cursor	01/2000 - 11/2004	B 180 APC	B 180 EHD	B 185 APC	
EuroTrakker MP 380 E 35 W Cursor	01/2000 - 11/2004	B 180 APC	B 180 EHD	B 185 APC	
EuroTrakker MP 380 E 37 H	01/1994 - 11/2004	B 180 APC	B 180 EHD / B 160 EHD	B 185 APC	
EuroTrakker MP 380 E 37 H	11/1999 - 11/2004	B 180 APC	B 180 EHD / B 160 EHD	B 185 APC	
EuroTrakker MP 380 E 37 W	01/1993 - 11/2004	B 180 APC	B 180 EHD / B 160 EHD	B 185 APC	
EuroTrakker MP 380 E 37 W	11/1999 - 11/2004	B 180 APC	B 180 EHD / B 160 EHD	B 185 APC	
EuroTrakker MP 380 E 38 H Cursor	01/2001 - 11/2004	B 180 APC	B 180 EHD / B 160 EHD	B 185 APC	
EuroTrakker MP 380 E 38 HB Cursor	01/2001 - 11/2004	B 180 APC	B 180 EHD	B 185 APC	

MARCHIO E MODELLO - MAKE AND MODEL MARQUE ET MODÈLE - MARKE UND MODELL MARCA Y MODELO - МАРКА И МОДЕЛЬ	Periodo Period	powerCUBE		energyCUBE	
		APC	EHD	APC	RST
IVECO					
<i>cont.</i>					
EuroTrakker MP 380 E 38 W Cursor	01/2001 - 11/2004	B 180 APC	B 180 EHD / B 160 EHD	B 185 APC	
EuroTrakker MP 380 E 42 H	01/1993 - 11/2004	B 180 APC	B 180 EHD / B 160 EHD	B 185 APC	
EuroTrakker MP 380 E 42 W	01/1993 - 11/2004	B 180 APC	B 180 EHD / B 160 EHD	B 185 APC	
EuroTrakker MP 380 E 42 W	11/1999 - 11/2004	B 180 APC	B 180 EHD / B 160 EHD	B 185 APC	
EuroTrakker MP 380 E 44 H Cursor	01/2001 - 11/2004	B 180 APC	B 180 EHD / B 160 EHD	B 185 APC	
EuroTrakker MP 380 E 44 HB Cursor	01/2001 - 11/2004	B 180 APC	B 180 EHD	B 185 APC	
EuroTrakker MP 380 E 44 W	01/2001 - 11/2004	B 180 APC	B 180 EHD / B 160 EHD	B 185 APC	
EuroTrakker MP 380 E 44 W Cursor	01/2001 - 11/2004	B 180 APC	B 180 EHD / B 160 EHD	B 185 APC	
EuroTrakker MP 380 E 47 H	11/1999 - 11/2004	B 180 APC	B 180 EHD	B 185 APC	
EuroTrakker MP 380 E 47 W	11/1999 - 11/2004	B 180 APC	B 180 EHD / B 160 EHD	B 185 APC	
EuroTrakker MP 400 E 34 HT	01/1993 - 11/2004	B 180 APC	B 180 EHD / B 160 EHD	B 185 APC	
EuroTrakker MP 400 E 35 HT Cursor	01/2000 - 11/2004	B 180 APC	B 180 EHD	B 185 APC	
EuroTrakker MP 400 E 37 HT	01/1993 - 11/2004	B 180 APC	B 180 EHD / B 160 EHD	B 185 APC	
EuroTrakker MP 400 E 37 WT	01/1997 - 11/2004	B 180 APC	B 180 EHD / B 160 EHD	B 185 APC	
EuroTrakker MP 400 E 42 HT	01/1995 - 11/2004	B 180 APC	B 180 EHD / B 160 EHD	B 185 APC	
EuroTrakker MP 400 E 42 WT	01/1997 - 11/2004	B 180 APC	B 180 EHD / B 160 EHD	B 185 APC	
EuroTrakker MP 410 E 35 H Cursor	01/2000 - 11/2004	B 180 APC	B 180 EHD	B 185 APC	
EuroTrakker MP 410 E 37 H	01/1994 - 11/2004	B 180 APC	B 180 EHD / B 160 EHD	B 185 APC	
EuroTrakker MP 410 E 37 H	11/1999 - 11/2004	B 180 APC	B 180 EHD	B 185 APC	
EuroTrakker MP 410 E 37 W	11/1999 - 11/2004	B 180 APC	B 180 EHD	B 185 APC	
EuroTrakker MP 410 E 38 H Cursor	01/2001 - 11/2004	B 180 APC	B 180 EHD / B 160 EHD	B 185 APC	
EuroTrakker MP 410 E 38 HB Cursor	01/2001 - 11/2004	B 180 APC	B 180 EHD	B 185 APC	
EuroTrakker MP 410 E 42 H	01/1994 - 11/2004	B 180 APC	B 180 EHD / B 160 EHD	B 185 APC	
EuroTrakker MP 410 E 42 H	11/1999 - 11/2004	B 180 APC	B 180 EHD	B 185 APC	
EuroTrakker MP 410 E 42 W	01/1997 - 11/2004	B 180 APC	B 180 EHD / B 160 EHD	B 185 APC	
EuroTrakker MP 410 E 44 H Cursor	01/2001 - 11/2004	B 180 APC	B 180 EHD / B 160 EHD	B 185 APC	
EuroTrakker MP 410 E 44 HB Cursor	01/2001 - 11/2004	B 180 APC	B 180 EHD	B 185 APC	
EuroTrakker MP 410 E 47 H	11/1999 - 11/2004	B 180 APC	B 180 EHD	B 185 APC	
EuroTrakker MP 410 E 47 W	11/1999 - 11/2004	B 180 APC	B 180 EHD	B 185 APC	
EuroTrakker MP 440 E 34 HT	01/1994 - 11/2004	B 180 APC	B 180 EHD / B 160 EHD	B 185 APC	
EuroTrakker MP 440 E 37 HT	01/1993 - 11/2004	B 180 APC	B 180 EHD / B 160 EHD	B 185 APC	
EuroTrakker MP 440 E 38 HT Cursor	01/2001 - 11/2004	B 180 APC	B 180 EHD	B 185 APC	
EuroTrakker MP 440 E 42 HT	01/1997 - 11/2004	B 180 APC	B 180 EHD / B 160 EHD	B 185 APC	
EuroTrakker MP 440 E 44 HT Cursor	01/2001 - 11/2004	B 180 APC	B 180 EHD	B 185 APC	
EuroTrakker MP 440 E 47 HT	11/1999 - 11/2004	B 180 APC	B 180 EHD	B 185 APC	
EuroTrakker MP 720 E 37 HT	01/1994 - 11/2004	B 180 APC	B 180 EHD / B 160 EHD	B 185 APC	
EuroTrakker MP 720 E 37 WT	01/1997 - 11/2004	B 180 APC	B 180 EHD / B 160 EHD	B 185 APC	
EuroTrakker MP 720 E 38 HT Cursor	01/2001 - 11/2004	B 180 APC	B 180 EHD	B 185 APC	
EuroTrakker MP 720 E 42 HT	01/1994 - 11/2004	B 180 APC	B 180 EHD / B 160 EHD	B 185 APC	
EuroTrakker MP 720 E 42 WT	01/1997 - 11/2004	B 180 APC	B 180 EHD / B 160 EHD	B 185 APC	
EuroTrakker MP 720 E 44 HT Cursor	01/2001 - 11/2004	B 180 APC	B 180 EHD	B 185 APC	
EuroTrakker MP 720 E 47 HT	09/1998 - 11/2004	B 180 APC	B 180 EHD / B 160 EHD	B 185 APC	
EuroTrakker MP 720 E 48 HT Cursor	01/2001 - 11/2004	B 180 APC	B 180 EHD	B 185 APC	
EuroTrakker MPÜ 410 E 38 H Cursor	01/2001 - 11/2004	B 180 APC	B 180 EHD / B 160 EHD	B 185 APC	
M 115-17	01/1986 - 12/1991	B 180 APC	B 180 EHD / B 160 EHD	B 185 APC	

MARCHIO E MODELLO - MAKE AND MODEL MARQUE ET MODÈLE - MARKE UND MODELL MARCA Y MODELO - МАРКА И МОДЕЛЬ	Periodo Period	powerCUBE		energyCUBE	
		APC	EHD	APC	RST
IVECO <small>cont.</small>					
M 115-17	09/1983 - 12/1985	B 180 APC	B 180 EHD / B 160 EHD	B 185 APC	
M 115-17 H	01/1986 - 12/1991	B 180 APC	B 180 EHD / B 160 EHD	B 185 APC	
M 135-17	01/1986 - 12/1991	B 180 APC	B 180 EHD / B 160 EHD	B 185 APC	
M 135-17	09/1983 - 12/1985	B 180 APC	B 180 EHD / B 160 EHD	B 185 APC	
M 135-17 H	01/1986 - 12/1992	B 180 APC	B 180 EHD / B 160 EHD	B 185 APC	
M 135-17 T	01/1986 - 12/1991	B 180 APC	B 180 EHD / B 160 EHD	B 185 APC	
M 135-17 T	09/1983 - 12/1985	B 180 APC	B 180 EHD / B 160 EHD	B 185 APC	
M 145-17	02/1986 - 12/1991	B 180 APC	B 180 EHD / B 160 EHD	B 185 APC	
M 159-17	07/1982 - 09/1986	B 180 APC	B 180 EHD / B 160 EHD	B 185 APC	
M 165-24 R	01/1985 - 12/1985	B 180 APC	B 180 EHD / B 160 EHD	B 185 APC	
M 165-24 R	06/1982 - 09/1986	B 180 APC	B 180 EHD / B 160 EHD	B 185 APC	
M 165-24 T	06/1982 - 09/1986	B 180 APC	B 180 EHD / B 160 EHD	B 185 APC	
M 175-17	09/1986 - 12/1992	B 180 APC	B 180 EHD / B 160 EHD	B 185 APC	
M 175-24	09/1986 - 11/1992	B 180 APC	B 180 EHD / B 160 EHD	B 185 APC	
M 175-24 T	09/1986 - 11/1992	B 180 APC	B 180 EHD / B 160 EHD	B 185 APC	
MK 110-13 A	01/1983 - 12/1991		D14 148 EHD		
MK 110-13 AH	01/1983 - 12/1985		D14 148 EHD		
MK 110-16 A	01/1983 - 12/1991		D14 148 EHD		
MK 110-16 AH	01/1983 - 12/1991		D14 148 EHD		
MK 110-16 AT	01/1983 - 12/1985		D14 148 EHD		
MK 130-13 A	01/1983 - 12/1991		D14 148 EHD		
MK 130-13 AH	01/1983 - 12/1991		D14 148 EHD		
MK 130-16 A	01/1983 - 12/1991		D14 148 EHD		
MK 130-16 AH	01/1983 - 12/1991		D14 148 EHD		
MK 75-9 A	01/1983 - 05/1989		D11 110 EHD / D11 135 EHD		
MK 75-9 H	01/1983 - 08/1985		D11 110 EHD / D11 135 EHD		
MK 80-13 A	01/1983 - 12/1991		D11 110 EHD / D11 135 EHD		
MK 80-13 AH	01/1983 - 12/1991		D11 110 EHD / D11 135 EHD		
MK 80-13 AT	01/1983 - 12/1991		D11 110 EHD / D11 135 EHD		
MK 80-13 AW	01/1983 - 12/1989		D11 110 EHD / D11 135 EHD		
MK 80-13 AW	01/1983 - 12/1991		D11 110 EHD / D11 135 EHD		
MK 80-16 A	01/1983 - 12/1991		D11 110 EHD / D11 135 EHD		
MK 80-16 AW	01/1986 - 12/1989		D11 110 EHD / D11 135 EHD		
MK 80-9 A	01/1983 - 02/1986		D11 110 EHD / D11 135 EHD		

MARCHIO E MODELLO - MAKE AND MODEL MARQUE ET MODÈLE - MARKE UND MODELL MARCA Y MODELO - МАРКА И МОДЕЛЬ	Periodo Period	powerCUBE		energyCUBE	
		APC	EHD	APC	RST
IVECO					
cont.					
MK 80-9 AH	01/1983 - 02/1986		D11 110 EHD / D11 135 EHD		
MK 90-13 A	01/1983 - 12/1991		D11 110 EHD / D11 135 EHD		
MK 90-13 AH	01/1983 - 12/1991		D11 110 EHD / D11 135 EHD		
P/PA 159-17 H	07/1982 - 09/1986	B 180 APC	B 180 EHD / B 160 EHD	B 185 APC	
P/PA 160-23 AH	04/1984 - 05/1989	B 180 APC	B 180 EHD / B 160 EHD	B 185 APC	
P/PA 160-23 AHW	01/1985 - 12/1985	B 180 APC	B 180 EHD / B 160 EHD	B 185 APC	
P/PA 160-23 AHW	04/1984 - 05/1989	B 180 APC	B 180 EHD / B 160 EHD	B 185 APC	
P/PA 160-30 AH	06/1986 - 05/1989	B 180 APC	B 180 EHD / B 160 EHD	B 185 APC	
P/PA 160-30 AHW	06/1986 - 05/1989	B 180 APC	B 180 EHD / B 160 EHD	B 185 APC	
P/PA 170-23 AH	04/1988 - 12/1990	B 180 APC	B 180 EHD / B 160 EHD	B 185 APC	
P/PA 170-23 AH,180-23 AH	01/1991 - 12/1993	B 180 APC	B 180 EHD / B 160 EHD	B 185 APC	
P/PA 170-23 AHW	04/1988 - 12/1990	B 180 APC	B 180 EHD / B 160 EHD	B 185 APC	
P/PA 170-23 AHW,180-23 AHW	01/1991 - 12/1993	B 180 APC	B 180 EHD / B 160 EHD	B 185 APC	
P/PA 170-25 AH	03/1989 - 12/1990	B 180 APC	B 180 EHD / B 160 EHD	B 185 APC	
P/PA 170-25 AH,180-25 AH	01/1991 - 12/1993	B 180 APC	B 180 EHD / B 160 EHD	B 185 APC	
P/PA 170-25 AHW	03/1989 - 12/1990	B 180 APC	B 180 EHD / B 160 EHD	B 185 APC	
P/PA 170-25 AHW,180-25 AHW	01/1991 - 12/1993	B 180 APC	B 180 EHD / B 160 EHD	B 185 APC	
P/PA 170-34 AH	01/1991 - 12/1993	B 180 APC	B 180 EHD / B 160 EHD	B 185 APC	
P/PA 170-34 AH	04/1989 - 12/1990	B 180 APC	B 180 EHD / B 160 EHD	B 185 APC	
P/PA 170-34 AH,180-34 AH	01/1991 - 12/1993	B 180 APC	B 180 EHD / B 160 EHD	B 185 APC	
P/PA 170-34 AHW	04/1989 - 12/1990	B 180 APC	B 180 EHD / B 160 EHD	B 185 APC	
P/PA 170-34 AHW,180-34 AHW	01/1991 - 12/1993	B 180 APC	B 180 EHD / B 160 EHD	B 185 APC	
P/PA 190-25 AH	07/1983 - 06/1986	B 180 APC	B 180 EHD / B 160 EHD	B 185 APC	
P/PA 190-25 AHW	07/1983 - 06/1986	B 180 APC	B 180 EHD / B 160 EHD	B 185 APC	
P/PA 190-30 H	01/1991 - 12/1992	B 180 APC	B 180 EHD / B 160 EHD	B 185 APC	
P/PA 190-30 H	04/1987 - 12/1990	B 180 APC	B 180 EHD / B 160 EHD	B 185 APC	
P/PA 190-30 HT	01/1989 - 12/1990	B 180 APC	B 180 EHD / B 160 EHD	B 185 APC	
P/PA 190-30 HT	01/1990 - 12/1992	B 180 APC	B 180 EHD / B 160 EHD	B 185 APC	
P/PA 190-30 HW	01/1991 - 12/1992	B 180 APC	B 180 EHD / B 160 EHD	B 185 APC	
P/PA 190-30 HW	04/1987 - 12/1990	B 180 APC	B 180 EHD / B 160 EHD	B 185 APC	
P/PA 190-32 AH	01/1983 - 12/1985	B 180 APC	B 180 EHD / B 160 EHD	B 185 APC	
P/PA 190-32 AHW	01/1983 - 12/1985	B 180 APC	B 180 EHD / B 160 EHD	B 185 APC	
P/PA 260-25 AH	03/1984 - 06/1986	B 180 APC	B 180 EHD / B 160 EHD	B 185 APC	
P/PA 260-25 AH	04/1989 - 12/1992	B 180 APC	B 180 EHD / B 160 EHD	B 185 APC	
P/PA 260-25 AHB	03/1984 - 06/1986	B 180 APC	B 180 EHD / B 160 EHD	B 185 APC	
P/PA 260-25 AHB	12/1979 - 10/1985	B 180 APC	B 180 EHD / B 160 EHD	B 185 APC	
P/PA 260-25 AHW	03/1984 - 06/1986	B 180 APC	B 180 EHD / B 160 EHD	B 185 APC	
P/PA 260-30 AH	06/1986 - 05/1990	B 180 APC	B 180 EHD / B 160 EHD	B 185 APC	
P/PA 260-30 AHT	06/1986 - 05/1990	B 180 APC	B 180 EHD / B 160 EHD	B 185 APC	
P/PA 260-30 AHW	06/1986 - 05/1990	B 180 APC	B 180 EHD / B 160 EHD	B 185 APC	
P/PA 260-32 AH	01/1983 - 12/1985	B 180 APC	B 180 EHD / B 160 EHD	B 185 APC	
P/PA 260-32 AHT	01/1983 - 12/1985	B 180 APC	B 180 EHD / B 160 EHD	B 185 APC	

MARCHIO E MODELLO - MAKE AND MODEL MARQUE ET MODÈLE - MARKE UND MODELL MARCA Y MODELO - МАРКА И МОДЕЛЬ	Periodo Period	powerCUBE		energyCUBE	
		APC	EHD	APC	RST
IVECO	cont.				
P/PA 260-32 AHW	01/1983 - 12/1985	B 180 APC	B 180 EHD / B 160 EHD	B 185 APC	
P/PA 260-34 AH	01/1991 - 12/1992	B 180 APC	B 180 EHD / B 160 EHD	B 185 APC	
P/PA 260-34 AH	04/1989 - 12/1990	B 180 APC	B 180 EHD / B 160 EHD	B 185 APC	
P/PA 260-34 AHT	01/1991 - 12/1992	B 180 APC	B 180 EHD / B 160 EHD	B 185 APC	
P/PA 260-34 AHT	04/1989 - 12/1990	B 180 APC	B 180 EHD / B 160 EHD	B 185 APC	
P/PA 260-34 AHW	01/1991 - 12/1992	B 180 APC	B 180 EHD / B 160 EHD	B 185 APC	
P/PA 300-30 AH	04/1987 - 05/1989	B 180 APC	B 180 EHD / B 160 EHD	B 185 APC	
P/PA 300-30 AHB	04/1987 - 05/1989	B 180 APC	B 180 EHD / B 160 EHD	B 185 APC	
P/PA 330-30 H	01/1988 - 12/1990	B 180 APC	B 180 EHD / B 160 EHD	B 185 APC	
P/PA 330-30 H	01/1991 - 12/1992	B 180 APC	B 180 EHD / B 160 EHD	B 185 APC	
P/PA 330-30 H	06/1984 - 12/1990	B 180 APC	B 180 EHD / B 160 EHD	B 185 APC	
P/PA 330-30 H	06/1984 - 12/1992	B 180 APC	B 180 EHD / B 160 EHD	B 185 APC	
P/PA 330-30 HT	01/1988 - 12/1990	B 180 APC	B 180 EHD / B 160 EHD	B 185 APC	
P/PA 330-30 HT	01/1988 - 12/1992	B 180 APC	B 180 EHD / B 160 EHD	B 185 APC	
P/PA 330-30 HT	01/1991 - 12/1992	B 180 APC	B 180 EHD / B 160 EHD	B 185 APC	
P/PA 330-30 HW	01/1988 - 12/1990	B 180 APC	B 180 EHD / B 160 EHD	B 185 APC	
P/PA 330-30 HW	01/1988 - 12/1992	B 180 APC	B 180 EHD / B 160 EHD	B 185 APC	
P/PA 330-30 HW	01/1991 - 12/1992	B 180 APC	B 180 EHD / B 160 EHD	B 185 APC	
P/PA 330-36 H	01/1989 - 12/1990	B 180 APC	B 180 EHD / B 160 EHD	B 185 APC	
P/PA 330-36 H	01/1989 - 12/1992	B 180 APC	B 180 EHD / B 160 EHD	B 185 APC	
P/PA 330-36 H	01/1991 - 12/1992	B 180 APC	B 180 EHD / B 160 EHD	B 185 APC	
P/PA 330-36 HT	01/1989 - 12/1990	B 180 APC	B 180 EHD / B 160 EHD	B 185 APC	
P/PA 330-36 HT	01/1989 - 12/1992	B 180 APC	B 180 EHD / B 160 EHD	B 185 APC	
P/PA 330-36 HT	01/1991 - 12/1992	B 180 APC	B 180 EHD / B 160 EHD	B 185 APC	
P/PA 330-36 HW	01/1989 - 10/1990	B 180 APC	B 180 EHD / B 160 EHD	B 185 APC	
P/PA 330-36 HW	01/1989 - 12/1992	B 180 APC	B 180 EHD / B 160 EHD	B 185 APC	
P/PA 330-36 HW	01/1991 - 12/1992	B 180 APC	B 180 EHD / B 160 EHD	B 185 APC	
P/PA 340-34 AH	03/1989 - 12/1992	B 180 APC	B 180 EHD / B 160 EHD	B 185 APC	
P/PA Veicolo con cabina arretrata 120-13 ANW	01/1983 - 09/1990	B 180 APC	B 180 EHD / B 160 EHD	B 185 APC	
P/PA Veicolo con cabina arretrata 120-16 ANW, 120-17 ANW	01/1983 - 11/1989	B 180 APC	B 180 EHD / B 160 EHD	B 185 APC	
P/PA Veicolo con cabina arretrata 150-16 AN	01/1983 - 12/1991	B 180 APC	B 180 EHD / B 160 EHD	B 185 APC	
P/PA Veicolo con cabina arretrata 150-16 ANW	01/1983 - 12/1991	B 180 APC	B 180 EHD / B 160 EHD	B 185 APC	
P/PA Veicolo con cabina arretrata 160-17 AN	07/1989 - 12/1993	B 180 APC	B 180 EHD / B 160 EHD	B 185 APC	
P/PA Veicolo con cabina arretrata 160-17 ANW	07/1989 - 12/1993	B 180 APC	B 180 EHD / B 160 EHD	B 185 APC	
P/PA Veicolo con cabina arretrata 160-23 ANW	01/1986 - 05/1989	B 180 APC	B 180 EHD / B 160 EHD	B 185 APC	
P/PA Veicolo con cabina arretrata 160-23 ANW	01/1988 - 05/1989	B 180 APC	B 180 EHD / B 160 EHD	B 185 APC	
P/PA Veicolo con cabina arretrata 160-23 ANW	04/1984 - 12/1985	B 180 APC	B 180 EHD / B 160 EHD	B 185 APC	
P/PA Veicolo con cabina arretrata 160-23 ANW	04/1985 - 12/1985	B 180 APC	B 180 EHD / B 160 EHD	B 185 APC	
P/PA Veicolo con cabina arretrata 170-23 ANW	01/1990 - 12/1990	B 180 APC	B 180 EHD / B 160 EHD	B 185 APC	
P/PA Veicolo con cabina arretrata 170-23 ANW	01/1991 - 12/1993	B 180 APC	B 180 EHD / B 160 EHD	B 185 APC	
P/PA Veicolo con cabina arretrata 170-23 ANW	04/1988 - 12/1990	B 180 APC	B 180 EHD / B 160 EHD	B 185 APC	
P/PA Veicolo con cabina arretrata 190-25 AN	01/1986 - 09/1990	B 180 APC	B 180 EHD / B 160 EHD	B 185 APC	
P/PA Veicolo con cabina arretrata 190-25 AN	07/1983 - 12/1986	B 180 APC	B 180 EHD / B 160 EHD	B 185 APC	
P/PA Veicolo con cabina arretrata 190-25 AN	07/1983 - 12/1987	B 180 APC	B 180 EHD / B 160 EHD	B 185 APC	
P/PA Veicolo con cabina arretrata 190-25 ANT	07/1983 - 06/1986	B 180 APC	B 180 EHD / B 160 EHD	B 185 APC	

MARCHIO E MODELLO - MAKE AND MODEL MARQUE ET MODÈLE - MARKE UND MODELL MARCA Y MODELO - МАРКА И МОДЕЛЬ	Periodo Period	powerCUBE		energyCUBE	
		APC	EHD	APC	RST
IVECO					
cont.					
P/PA Veicolo con cabina arretrata 190-25 ANT	07/1986 - 12/1987	B 180 APC	B 180 EHD / B 160 EHD	B 185 APC	
P/PA Veicolo con cabina arretrata 190-25 ANW	01/1986 - 09/1990	B 180 APC	B 180 EHD / B 160 EHD	B 185 APC	
P/PA Veicolo con cabina arretrata 190-25 ANW	07/1983 - 12/1986	B 180 APC	B 180 EHD / B 160 EHD	B 185 APC	
P/PA Veicolo con cabina arretrata 190-25 ANW	07/1983 - 12/1987	B 180 APC	B 180 EHD / B 160 EHD	B 185 APC	
P/PA Veicolo con cabina arretrata 190-30 N	01/1991 - 12/1993	B 180 APC	B 180 EHD / B 160 EHD	B 185 APC	
P/PA Veicolo con cabina arretrata 190-30 N	04/1987 - 12/1990	B 180 APC	B 180 EHD / B 160 EHD	B 185 APC	
P/PA Veicolo con cabina arretrata 190-30 NT	01/1991 - 12/1993	B 180 APC	B 180 EHD / B 160 EHD	B 185 APC	
P/PA Veicolo con cabina arretrata 190-30 NT	04/1987 - 12/1990	B 180 APC	B 180 EHD / B 160 EHD	B 185 APC	
P/PA Veicolo con cabina arretrata 260-25 AN	07/1983 - 06/1986	B 180 APC	B 180 EHD / B 160 EHD	B 185 APC	
P/PA Veicolo con cabina arretrata 260-25 ANW	07/1983 - 06/1986	B 180 APC	B 180 EHD / B 160 EHD	B 185 APC	
P/PA Veicolo con cabina arretrata 330-30 AN	05/1986 - 09/1990	B 180 APC	B 180 EHD / B 160 EHD	B 185 APC	
P/PA Veicolo con cabina arretrata 330-30 ANW	05/1986 - 09/1990	B 180 APC	B 180 EHD / B 160 EHD	B 185 APC	
P/PA Veicolo con cabina arretrata 330-30 N	01/1991 - 12/1992	B 180 APC	B 180 EHD / B 160 EHD	B 185 APC	
P/PA Veicolo con cabina arretrata 330-30 N	10/1987 - 12/1990	B 180 APC	B 180 EHD / B 160 EHD	B 185 APC	
P/PA Veicolo con cabina arretrata 330-30 N	10/1987 - 12/1992	B 180 APC	B 180 EHD / B 160 EHD	B 185 APC	
P/PA Veicolo con cabina arretrata 330-30 NW	01/1991 - 12/1992	B 180 APC	B 180 EHD / B 160 EHD	B 185 APC	
P/PA Veicolo con cabina arretrata 330-30 NW	10/1987 - 12/1990	B 180 APC	B 180 EHD / B 160 EHD	B 185 APC	
P/PA Veicolo con cabina arretrata 330-30 NW	10/1987 - 12/1992	B 180 APC	B 180 EHD / B 160 EHD	B 185 APC	
Stralis AD 190S27, AT 190S27	04/2004 -	B 180 APC	B 180 EHD	B 185 APC	
Stralis AD 190S27, AT 190S27	05/2005 -	B 180 APC	B 180 EHD	B 185 APC	
Stralis AD 190S30	04/2004 -	B 180 APC	B 180 EHD	B 185 APC	
Stralis AD 190S31 (P, /FP D), AT 190S31 (P, /FP D)	06/2003 -	B 180 APC	B 180 EHD	B 185 APC	
Stralis AD 190S31, AT 190S31	04/2004 -	B 180 APC	B 180 EHD	B 185 APC	
Stralis AD 190S33, AT 190S33	05/2007 -	B 180 APC	B 180 EHD	B 185 APC	
Stralis AD 190S33, AT 190S33	12/2006 -	B 180 APC	B 180 EHD	B 185 APC	
Stralis AD 190S35	04/2004 -	B 180 APC	B 180 EHD	B 185 APC	
Stralis AD 190S35 (P, /FP D), AT 190S35 (P, /FP D)	06/2003 -	B 180 APC	B 180 EHD	B 185 APC	
Stralis AD 190S36, AT 190S36	05/2007 -	B 180 APC	B 180 EHD	B 185 APC	
Stralis AD 190S40 (P, /FP D), AT 190S40 (P, /FP D)	06/2003 -	B 180 APC	B 180 EHD	B 185 APC	
Stralis AD 190S42, AT 190S42	12/2006 -	B 180 APC	B 180 EHD	B 185 APC	
Stralis AD 190S43 (P, /FP D), AT 190S43 (P, /FP D)	06/2003 -	B 180 APC	B 180 EHD	B 185 APC	
Stralis AD 190S45, AT 190S45	12/2006 -	B 180 APC	B 180 EHD	B 185 APC	
Stralis AD 190S46, AT 190S46, AS 190S46	01/2013 -	CX 225 APC		CX 220 APC	
Stralis AD 260S27 CNG, AT 260S27	01/2008 -	B 180 APC		B 185 APC	
Stralis AD 260S27, AT 260S27	04/2004 -	B 180 APC	B 180 EHD	B 185 APC	
Stralis AD 260S30, AT 260S30	04/2004 -	B 180 APC	B 180 EHD	B 185 APC	
Stralis AD 260S30, AT 260S30	10/2005 -	B 180 APC		B 185 APC	
Stralis AD 260S31 (Y/P, Y/PS, Y/PT), AT 260S31 (Y/P, Y/PS, Y/PT)	06/2003 -	B 180 APC	B 180 EHD	B 185 APC	
Stralis AD 260S31, AT 260S31	04/2004 -	B 180 APC	B 180 EHD	B 185 APC	
Stralis AD 260S33, AT 260S33	06/2007 -	B 180 APC	B 180 EHD	B 185 APC	
Stralis AD 260S33, AT 260S33	12/2006 -	B 180 APC	B 180 EHD	B 185 APC	
Stralis AD 260S35	04/2004 -	B 180 APC	B 180 EHD	B 185 APC	
Stralis AD 260S35 (Y/P, Y/PS, Y/PT), AT 260S35 (Y/P, Y/PS, Y/PT)	06/2003 -	B 180 APC	B 180 EHD	B 185 APC	
Stralis AD 260S36, AT 260S36	07/2007 -	B 180 APC	B 180 EHD	B 185 APC	
Stralis AD 260S40 (Y/P, Y/PS, Y/PT), AT 260S40 (Y/P, Y/PS, Y/PT)	06/2003 -	B 180 APC	B 180 EHD	B 185 APC	

MARCHIO E MODELLO - MAKE AND MODEL MARQUE ET MODÈLE - MARKE UND MODELL MARCA Y MODELO - МАРКА И МОДЕЛЬ	Periodo Period	powerCUBE		energyCUBE	
		APC	EHD	APC	RST
IVECO cont.					
Stralis AD 260S42, AT 260S42	12/2006 -	B 180 APC	B 180 EHD	B 185 APC	
Stralis AD 260S42, AT 260S42, AS 260S42	05/2007 -	B 180 APC	B 180 EHD	B 185 APC	
Stralis AD 260S43 (Y/P, Y/PS, Y/PT), AT 260S43 (Y/P, Y/PS, Y/PT)	06/2003 -	B 180 APC	B 180 EHD	B 185 APC	
Stralis AD 260S45, AT 260S45	12/2006 -	B 180 APC	B 180 EHD	B 185 APC	
Stralis AD 260S45, AT 260S45, AS 260S45	05/2007 -	B 180 APC	B 180 EHD	B 185 APC	
Stralis AD 320S36	01/2013 -	CX 225 APC		CX 220 APC	
Stralis AD 320S36	05/2007 -	B 180 APC		B 185 APC	
Stralis AD 320S42, AT 320S42	05/2007 -	CX 225 APC		CX 220 APC	
Stralis AD 320S45, AT 320S45	05/2007 -	CX 225 APC		CX 220 APC	
Stralis AD 440S31	06/2003 -	B 180 APC		B 185 APC	
Stralis AD 440S33, AT 440S33	12/2006 -	B 180 APC		B 185 APC	
Stralis AD 440S35 (T/P, T/P HR), AT 440S35 (T/P, T/P HR)	06/2003 -	B 180 APC		B 185 APC	
Stralis AD 440S40 (T/P, T/P HR, LT), AT 440S40 (T/P, T/P HR, LT)	06/2003 -	CX 225 APC		CX 220 APC	
Stralis AD 440S40 TX/P, AT 440S40 TX/P	06/2003 -	CX 225 APC		CX 220 APC	
Stralis AD 440S42, AT 440S42	12/2006 -	CX 225 APC		CX 220 APC	
Stralis AD 440S43 (T/P, T/P HR, LT), AT 440S43 (T/P, T/P HR, LT)	06/2003 -	CX 225 APC		CX 220 APC	
Stralis AD 440S43 TX/P, AT 440S43 TX/P	06/2003 -	CX 225 APC		CX 220 APC	
Stralis AD 440S45, AT 440S45	12/2006 -	CX 225 APC		CX 220 APC	
Stralis AS 190S40 (P, /FP-CM, /FP GV)	02/2002 -	B 180 APC	B 180 EHD	B 185 APC	
Stralis AS 190S43 (P, /FP-CM, /FP GV)	02/2002 -	B 180 APC	B 180 EHD	B 185 APC	
Stralis AS 190S45	12/2006 -	B 180 APC	B 180 EHD	B 185 APC	
Stralis AS 190S48 (P, /FP CM, /FP GV)	02/2002 -	B 180 APC	B 180 EHD	B 185 APC	
Stralis AS 190S50	12/2006 -	B 180 APC	B 180 EHD	B 185 APC	
Stralis AS 260S40	05/2005 -	B 180 APC	B 180 EHD	B 185 APC	
Stralis AS 260S40/ (PS, FP-CM, FS-CM, FP-GV)	02/2002 -	B 180 APC	B 180 EHD	B 185 APC	
Stralis AS 260S43	05/2005 -	B 180 APC	B 180 EHD	B 185 APC	
Stralis AS 260S43/ (PS, FP-CM, FS-CM, FP-GV)	02/2002 -	B 180 APC	B 180 EHD	B 185 APC	
Stralis AS 260S48 Z/P	02/2002 -	B 180 APC	B 180 EHD	B 185 APC	
Stralis AS 260S48/PS	02/2002 -	B 180 APC	B 180 EHD	B 185 APC	
Stralis AS 260S50	07/2006 -	B 180 APC	B 180 EHD	B 185 APC	
Stralis AS 260S50	12/2006 -	B 180 APC	B 180 EHD	B 185 APC	
Stralis AS 260S54	02/2002 -	B 180 APC	B 180 EHD	B 185 APC	
Stralis AS 260S54/PS	02/2002 -	B 180 APC	B 180 EHD	B 185 APC	
Stralis AS 260S56	07/2006 -	B 180 APC	B 180 EHD	B 185 APC	
Stralis AS 260S56	12/2006 -	B 180 APC	B 180 EHD	B 185 APC	
Stralis AS 320S50	05/2007 -	CX 225 APC		CX 220 APC	
Stralis AS 440 S 40 T/P	02/2002 -	CX 225 APC		CX 220 APC	
Stralis AS 440S40	02/2002 -	CX 225 APC		CX 220 APC	
Stralis AS 440S40 (T/P, T/FP-LT)	02/2002 -	CX 225 APC		CX 220 APC	
Stralis AS 440S40 TX/P	02/2002 -	CX 225 APC		CX 220 APC	
Stralis AS 440S42	07/2006 -	CX 225 APC		CX 220 APC	
Stralis AS 440S42, AT 440S42	12/2006 -	CX 225 APC		CX 220 APC	
Stralis AS 440S43 (T/P, T/FP-LT)	02/2002 -	CX 225 APC		CX 220 APC	
Stralis AS 440S43 TX/P	02/2002 -	CX 225 APC		CX 220 APC	
Stralis AS 440S45	12/2006 -	CX 225 APC		CX 220 APC	

MARCHIO E MODELLO - MAKE AND MODEL MARQUE ET MODÈLE - MARKE UND MODELL MARCA Y MODELO - МАРКА И МОДЕЛЬ	Periodo Period	powerCUBE		energyCUBE	
		APC	EHD	APC	RST
IVECO					
<i>cont.</i>					
Stralis AS 440S45, AT 440S45	12/2006 -	CX 225 APC		CX 220 APC	
Stralis AS 440S48	02/2002 -	CX 225 APC		CX 220 APC	
Stralis AS 440S48 T/ZP	02/2002 -	CX 225 APC		CX 220 APC	
Stralis AS 440S48 TX/P	02/2002 -	CX 225 APC		CX 220 APC	
Stralis AS 440S50	07/2006 -	CX 225 APC		CX 220 APC	
Stralis AS 440S50	12/2006 -	CX 225 APC		CX 220 APC	
Stralis AS 440S50, AT 440S50	12/2006 -	CX 225 APC		CX 220 APC	
Stralis AS 440S54	02/2002 -	CX 225 APC		CX 220 APC	
Stralis AS 440S54 T/P, T/FP-LT	02/2002 -	CX 225 APC		CX 220 APC	
Stralis AS 440S54 T/ZP	02/2002 -	CX 225 APC		CX 220 APC	
Stralis AS 440S54 TX/P, ES 440S54 T/P	02/2002 -	CX 225 APC		CX 220 APC	
Stralis AS 440S56	07/2006 -	CX 225 APC		CX 220 APC	
Stralis AS 440S56	12/2006 -	CX 225 APC		CX 220 APC	
Stralis AS 440S56, AT 440S56	12/2006 -	CX 225 APC		CX 220 APC	
Stralis AT 440S40	06/2003 -	B 180 APC		B 185 APC	
Stralis AT 440S42	07/2006 -	CX 225 APC		CX 220 APC	
Stralis AT 440S43	06/2003 -	CX 225 APC		CX 220 APC	
Stralis AT 440S43 TX/P	06/2003 -	CX 225 APC		CX 220 APC	
Stralis AT 440S45	07/2006 -	CX 225 APC		CX 220 APC	
Stralis ES 440S48	10/2004 -	CX 225 APC		CX 220 APC	
Stralis ES 440S54	10/2004 -	CX 225 APC		CX 220 APC	
Strator ASN 440S42T	04/2010 -	CX 225 APC		CX 220 APC	
Strator ASN 440S42TX	04/2010 -	CX 225 APC		CX 220 APC	
Strator ASN 440S45T	04/2010 -	CX 225 APC		CX 220 APC	
Strator ASN 440S45TX	04/2010 -	CX 225 APC		CX 220 APC	
Strator ASN 440S50T	04/2010 -	CX 225 APC		CX 220 APC	
Strator ASN 440S50TX	04/2010 -	CX 225 APC		CX 220 APC	
Strator ASN 440S50TZ	04/2010 -	CX 225 APC		CX 220 APC	
Strator ASN 440S56T	04/2010 -	CX 225 APC		CX 220 APC	
Strator ASN 440S56TX	04/2010 -	CX 225 APC		CX 220 APC	
Strator ASN 440S56TZ	04/2010 -	CX 225 APC		CX 220 APC	
Trakker AD 180T27 W, AT 18027 W	06/2005 -	CX 225 APC	CX 200 EHD	CX 220 APC	
Trakker AD 190T27, AT 190T27	06/2005 -	B 180 APC	B 180 EHD	B 185 APC	
Trakker AD 190T31 , AT 190T31	10/2004 -	B 180 APC	B 180 EHD	B 185 APC	
Trakker AD 190T31 W, AT 190T31 W	06/2005 -	B 180 APC	B 180 EHD	B 185 APC	
Trakker AD 190T31 W, AT 190T31 W	10/2004 -	B 180 APC	B 180 EHD	B 185 APC	
Trakker AD 190T31, AT 190T31	10/2004 -	B 180 APC	B 180 EHD	B 185 APC	
Trakker AD 190T33 W, AT 190T33 W	03/2006 -	B 180 APC	B 180 EHD	B 185 APC	
Trakker AD 190T33, AT 190T33	03/2006 -	B 180 APC	B 180 EHD	B 185 APC	
Trakker AD 190T35 , AT 190T35	10/2004 -	B 180 APC	B 180 EHD	B 185 APC	
Trakker AD 190T35 W, AT 190T35 W	10/2004 -	B 180 APC	B 180 EHD	B 185 APC	
Trakker AD 190T35 W, AT 190T35 W, AD 190T36W AT 190T36W	06/2005 -	B 180 APC	B 180 EHD	B 185 APC	
Trakker AD 190T35, AT 190T35, AD 190T36 AT 190T36	06/2005 -	B 180 APC	B 180 EHD	B 185 APC	
Trakker AD 190T38 , AT 190T38	10/2004 -	B 180 APC	B 180 EHD	B 185 APC	
Trakker AD 190T38 W , AT 190T38 W	10/2004 -	B 180 APC	B 180 EHD	B 185 APC	

MARCHIO E MODELLO - MAKE AND MODEL MARQUE ET MODÈLE - MARKE UND MODELL MARCA Y MODELO - МАРКА И МОДЕЛЬ	Periodo Period	powerCUBE		energyCUBE	
		APC	EHD	APC	RST
IVECO					
<i>cont.</i>					
Trakker AD 190T38 W, AT 190T38 W	06/2005 -	B 180 APC	B 180 EHD	B 185 APC	
Trakker AD 190T38, AT 190T38	10/2004 -	B 180 APC	B 180 EHD	B 185 APC	
Trakker AD 190T41 W, AT 190T41 W	03/2006 -	B 180 APC	B 180 EHD	B 185 APC	
Trakker AD 190T41, AT 190T41	03/2006 -	B 180 APC	B 180 EHD	B 185 APC	
Trakker AD 190T44 , AT 190T44	10/2004 -	B 180 APC	B 180 EHD	B 185 APC	
Trakker AD 190T44 W, AT 190T44 W	10/2004 -	B 180 APC	B 180 EHD	B 185 APC	
Trakker AD 190T44 W, AT 190T44 W, AD 190T45W, AT 190T45W	06/2005 -	B 180 APC	B 180 EHD	B 185 APC	
Trakker AD 190T44, AT 190T44 AD 19T45, AT 190T45	06/2005 -	B 180 APC	B 180 EHD	B 185 APC	
Trakker AD 260T31 , AT 260T31	10/2004 -	B 180 APC	B 180 EHD	B 185 APC	
Trakker AD 260T31 B	06/2005 -	B 180 APC	B 180 EHD	B 185 APC	
Trakker AD 260T31, AT 260T31	10/2004 -	B 180 APC	B 180 EHD	B 185 APC	
Trakker AD 260T33 B	07/2007 -	B 180 APC	B 180 EHD	B 185 APC	
Trakker AD 260T33, AD 380T33, AT 260T33, AT 380T33	03/2006 -	B 180 APC	B 180 EHD	B 185 APC	
Trakker AD 260T35 , AT 260T35	10/2004 -	B 180 APC	B 180 EHD	B 185 APC	
Trakker AD 260T35 B	06/2005 -	B 180 APC	B 180 EHD	B 185 APC	
Trakker AD 260T35 W, AT 260T35 W	06/2005 -	B 180 APC	B 180 EHD	B 185 APC	
Trakker AD 260T35, AT 260T35	10/2004 -	B 180 APC	B 180 EHD	B 185 APC	
Trakker AD 260T36 B	07/2007 -	B 180 APC	B 180 EHD	B 185 APC	
Trakker AD 260T36 W, AD 380T36 W, AT 260T36 W, AT 380T36 W	10/2004 -	B 180 APC	B 180 EHD	B 185 APC	
Trakker AD 260T36, AT 260T36	07/2007 -	B 180 APC	B 180 EHD	B 185 APC	
Trakker AD 260T38 , AT 260T38	10/2004 -	B 180 APC	B 180 EHD	B 185 APC	
Trakker AD 260T38 B	06/2005 -	B 180 APC	B 180 EHD	B 185 APC	
Trakker AD 260T38 W, AT 260T38 W	06/2005 -	B 180 APC	B 180 EHD	B 185 APC	
Trakker AD 260T38, AT 260T38		B 180 APC	B 180 EHD	B 185 APC	
Trakker AD 260T41 W, AD 380T41 W, AT 260T41 W, AT 380T41 W	03/2006 -	B 180 APC	B 180 EHD	B 185 APC	
Trakker AD 260T41, AD 380T41, AT 260T41, AT 380T41	03/2006 -	B 180 APC	B 180 EHD	B 185 APC	
Trakker AD 260T44 W, AT 260T44 W	06/2005 -	B 180 APC	B 180 EHD	B 185 APC	
Trakker AD 260T44, AT 260T44	06/2005 -	B 180 APC	B 180 EHD	B 185 APC	
Trakker AD 260T45 W, AD 380T45 W, AT 260T45 W, AT 380T45 W	03/2006 -	B 180 APC	B 180 EHD	B 185 APC	
Trakker AD 260T45, AD 380T45, AT 260T45, AT 380T45	03/2006 -	B 180 APC	B 180 EHD	B 185 APC	
Trakker AD 260T48, AT 260T48	06/2005 -	B 180 APC	B 180 EHD	B 185 APC	
Trakker AD 260T50, AD 380T50, AT 260T50, AT 380T50	03/2006 -	B 180 APC	B 180 EHD	B 185 APC	
Trakker AD 340T35 B, AT 340T35 B	06/2005 -	B 180 APC	B 180 EHD	B 185 APC	
Trakker AD 340T35, AT 340T35	06/2005 -	B 180 APC		B 185 APC	
Trakker AD 340T36 B	06/2006 -	B 180 APC	B 180 EHD	B 185 APC	
Trakker AD 340T36, AT 340T36	03/2006 -	B 180 APC	B 180 EHD	B 185 APC	
Trakker AD 340T36, AT 340T36	07/2007 -	B 180 APC	B 180 EHD	B 185 APC	
Trakker AD 340T38 B, AT 34T38 B	06/2005 -	B 180 APC	B 180 EHD	B 185 APC	
Trakker AD 340T41 B	06/2006 -	B 180 APC	B 180 EHD	B 185 APC	
Trakker AD 340T41, AT 340T41	03/2006 -	B 180 APC	B 180 EHD	B 185 APC	
Trakker AD 340T41, AT 340T41	06/2006 -	B 180 APC	B 180 EHD	B 185 APC	
Trakker AD 340T44 B, AT 340T44 B	06/2005 -	B 180 APC	B 180 EHD	B 185 APC	
Trakker AD 340T44, AT 340T44	06/2005 -	B 180 APC		B 185 APC	
Trakker AD 340T45 B	06/2006 -	B 180 APC	B 180 EHD	B 185 APC	
Trakker AD 340T45, AT 340T45	03/2006 -	B 180 APC	B 180 EHD	B 185 APC	

MARCHIO E MODELLO - MAKE AND MODEL MARQUE ET MODÈLE - MARKE UND MODELL MARCA Y MODELO - МАРКА И МОДЕЛЬ	Periodo Period	powerCUBE		energyCUBE	
		APC	EHD	APC	RST
IVECO					
<i>cont.</i>					
Trakker AD 340T45, AT 340T45	06/2006 -	B 180 APC	B 180 EHD	B 185 APC	
Trakker AD 340T50, AT 340T50	03/2006 -	B 180 APC	B 180 EHD	B 185 APC	
Trakker AD 380T35	01/2005 -	B 180 APC		B 185 APC	
Trakker AD 380T36 W	04/2006 -	B 180 APC		B 185 APC	
Trakker AD 380T38 B	06/2005 -	B 180 APC	B 180 EHD	B 185 APC	
Trakker AD 380T38, AT 380T38	06/2005 -	B 180 APC	B 180 EHD	B 185 APC	
Trakker AD 380T41 W, AT 380T41 W	09/2006 -	B 180 APC		B 185 APC	
Trakker AD 380T41, AT 380T41	09/2006 -	B 180 APC		B 185 APC	
Trakker AD 380T42 W	01/2005 -	B 180 APC		B 185 APC	
Trakker AD 380T44 B	06/2005 -	B 180 APC	B 180 EHD	B 185 APC	
Trakker AD 380T44 W, AT 380T44 W	06/2005 -	B 180 APC	B 180 EHD	B 185 APC	
Trakker AD 380T44, AT 380T44	06/2005 -	B 180 APC	B 180 EHD	B 185 APC	
Trakker AD 380T45 W, AT 380T45 W	09/2006 -	B 180 APC		B 185 APC	
Trakker AD 380T48, AD 380T48	06/2005 -	B 180 APC	B 180 EHD	B 185 APC	
Trakker AD 380T50	03/2007 -	B 180 APC	B 180 EHD	B 185 APC	
Trakker AD 400T35 T, AT 400T35 T	06/2005 -	B 180 APC	B 180 EHD	B 185 APC	
Trakker AD 400T36 T, AT 400T36 T	10/2004 -	B 180 APC	B 180 EHD	B 185 APC	
Trakker AD 400T38 T, AT 400T38 T	06/2005 -	B 180 APC	B 180 EHD	B 185 APC	
Trakker AD 400T38 WT, AT 400T38 WT	06/2005 -	B 180 APC	B 180 EHD	B 185 APC	
Trakker AD 400T41 T, AT 400T41 T	03/2006 -	B 180 APC	B 180 EHD	B 185 APC	
Trakker AD 400T41 WT, AT 400T41 WT	03/2006 -	B 180 APC	B 180 EHD	B 185 APC	
Trakker AD 400T44 T, AT 400T44 T	06/2005 -	B 180 APC	B 180 EHD	B 185 APC	
Trakker AD 400T44 WT, AT 400T44 WT	06/2005 -	B 180 APC	B 180 EHD	B 185 APC	
Trakker AD 400T45 T, AT 400T45 T	03/2006 -	B 180 APC	B 180 EHD	B 185 APC	
Trakker AD 400T45 WT, AT 400T45 WT	03/2006 -	B 180 APC	B 180 EHD	B 185 APC	
Trakker AD 400T50 T, AT 400T50 T	03/2006 -	B 180 APC	B 180 EHD	B 185 APC	
Trakker AD 410T35	02/2005 -	B 180 APC		B 185 APC	
Trakker AD 410T36, AT 410T36	03/2006 -	B 180 APC	B 180 EHD	B 185 APC	
Trakker AD 410T38	02/2005 -	B 180 APC		B 185 APC	
Trakker AD 410T38 B, AT 410T38 B	06/2005 -	B 180 APC	B 180 EHD	B 185 APC	
Trakker AD 410T38 H	04/2005 -	B 180 APC		B 185 APC	
Trakker AD 410T41, AT 410T41	03/2006 -	B 180 APC	B 180 EHD	B 185 APC	
Trakker AD 410T41, AT 410T41	06/2006 -	B 180 APC	B 180 EHD	B 185 APC	
Trakker AD 410T44 B, AT 410T44 B	06/2005 -	B 180 APC	B 180 EHD	B 185 APC	
Trakker AD 410T44 W, AT 410T44 W	06/2005 -	B 180 APC		B 185 APC	
Trakker AD 410T44, AT 410T44	02/2005 -	B 180 APC		B 185 APC	
Trakker AD 410T45 W	03/2006 -	B 180 APC	B 180 EHD	B 185 APC	
Trakker AD 410T45 W	07/2007 -	B 180 APC	B 180 EHD	B 185 APC	
Trakker AD 410T45, AT 410T45	03/2006 -	B 180 APC	B 180 EHD	B 185 APC	
Trakker AD 410T45, AT 410T45	06/2006 -	B 180 APC	B 180 EHD	B 185 APC	
Trakker AD 410T48 B, AT 410T48 B	06/2005 -	B 180 APC	B 180 EHD	B 185 APC	
Trakker AD 410T50, AT 410T50	03/2006 -	B 180 APC	B 180 EHD	B 185 APC	
Trakker AD 410T50, AT 410T50	06/2006 -	B 180 APC	B 180 EHD	B 185 APC	
Trakker AD 440T38 T, AT 440T38 T	06/2005 -	B 180 APC	B 180 EHD	B 185 APC	
Trakker AD 440T41 T, AT 440T41 T	03/2006 -	B 180 APC	B 180 EHD	B 185 APC	

MARCHIO E MODELLO - MAKE AND MODEL MARQUE ET MODÈLE - MARKE UND MODELL MARCA Y MODELO - МАРКА И МОДЕЛЬ	Periodo Period	powerCUBE		energyCUBE	
		APC	EHD	APC	RST
IVECO cont.					
Trakker AD 440T44 B	06/2005 -	B 180 APC	B 180 EHD	B 185 APC	
Trakker AD 440T44 T	06/2005 -	B 180 APC	B 180 EHD	B 185 APC	
Trakker AD 440T45 T, AT 440T45 T	03/2006 -	B 180 APC	B 180 EHD	B 185 APC	
Trakker AD 440T50 T, AT 440T50 T	03/2006 -	B 180 APC	B 180 EHD	B 185 APC	
Trakker AD 720T38 T, AT 720T38 T	06/2005 -	CX 225 APC	CX 200 EHD	CX 220 APC	
Trakker AD 720T38 WT, AT 720T38 WT	06/2005 -	CX 225 APC	CX 200 EHD	CX 220 APC	
Trakker AD 720T41 T, AT 720T41 T	03/2006 -	CX 225 APC	CX 200 EHD	CX 220 APC	
Trakker AD 720T41 WT, AT 720T41 WT	03/2006 -	CX 225 APC	CX 200 EHD	CX 220 APC	
Trakker AD 720T44 T, AT 720T44 T	06/2005 -	CX 225 APC	CX 200 EHD	CX 220 APC	
Trakker AD 720T44 W, AT 720T44 W	06/2005 -	CX 225 APC	CX 200 EHD	CX 220 APC	
Trakker AD 720T45 T, AT 720T45 T	03/2006 -	CX 225 APC	CX 200 EHD	CX 220 APC	
Trakker AD 720T45 WT, AT 720T45 WT	03/2006 -	CX 225 APC	CX 200 EHD	CX 220 APC	
Trakker AD 720T48 T, AT 720T48 T	06/2005 -	CX 225 APC	CX 200 EHD	CX 220 APC	
Trakker AD 720T50 T, AT 720T50 T	03/2006 -	CX 225 APC	CX 200 EHD	CX 220 APC	
Trakker AT 340T38	06/2005 -	B 180 APC		B 185 APC	
Trakker AT 340T38 W	09/2005 -	B 180 APC		B 185 APC	
Trakker AT 380T38 W	06/2005 -	B 180 APC		B 185 APC	
Trakker AT 400T42 TH	06/2005 -	B 180 APC		B 185 APC	
Trakker AT 410T48	06/2005 -	B 180 APC		B 185 APC	
Trakker AT 410T54		B 180 APC	B 180 EHD	B 185 APC	
Trakker AT 720T42 T	04/2005 -	B 180 APC		B 185 APC	
Trakker AT 720T42 WT	06/2005 -	B 180 APC		B 185 APC	
TurboStar 190-33	07/1984 - 09/1986	B 180 APC	B 180 EHD / B 160 EHD	B 185 APC	
TurboStar 190-33	10/1986 - 05/1987	B 180 APC	B 180 EHD / B 160 EHD	B 185 APC	
TurboStar 190-33 P	01/1986 - 12/1987	B 180 APC	B 180 EHD / B 160 EHD	B 185 APC	
TurboStar 190-33 T	07/1984 - 09/1986	B 180 APC	B 180 EHD / B 160 EHD	B 185 APC	
TurboStar 190-33 T	10/1986 - 05/1987	B 180 APC	B 180 EHD / B 160 EHD	B 185 APC	
TurboStar 190-36	07/1987 - 06/1990	B 180 APC	B 180 EHD / B 160 EHD	B 185 APC	
TurboStar 190-36	07/1990 - 12/1993	B 180 APC	B 180 EHD / B 160 EHD	B 185 APC	
TurboStar 190-36 P	07/1987 - 06/1990	B 180 APC	B 180 EHD / B 160 EHD	B 185 APC	
TurboStar 190-36 P	07/1990 - 12/1993	B 180 APC	B 180 EHD / B 160 EHD	B 185 APC	
TurboStar 190-36 T	07/1987 - 06/1990	B 180 APC	B 180 EHD / B 160 EHD	B 185 APC	
TurboStar 190-36 T	07/1990 - 12/1993	B 180 APC	B 180 EHD / B 160 EHD	B 185 APC	
TurboStar 190-42	07/1984 - 09/1986	B 180 APC	B 180 EHD / B 160 EHD	B 185 APC	
TurboStar 190-42	10/1986 - 12/1990	B 180 APC	B 180 EHD / B 160 EHD	B 185 APC	
TurboStar 190-42 T	07/1984 - 09/1986	B 180 APC	B 180 EHD / B 160 EHD	B 185 APC	
TurboStar 190-42 T	10/1986 - 12/1990	B 180 APC	B 180 EHD / B 160 EHD	B 185 APC	
TurboStar 190-48	03/1989 - 03/1991	B 180 APC	B 180 EHD / B 160 EHD	B 185 APC	
TurboStar 190-48	04/1991 - 12/1993	B 180 APC	B 180 EHD / B 160 EHD	B 185 APC	
TurboStar 190-48 T	03/1989 - 03/1991	B 180 APC	B 180 EHD / B 160 EHD	B 185 APC	
TurboStar 190-48 T	04/1991 - 12/1993	B 180 APC	B 180 EHD / B 160 EHD	B 185 APC	
TurboTech 190-26	01/1990 - 12/1992	B 180 APC	B 180 EHD / B 160 EHD	B 185 APC	
TurboTech 190-26 T	01/1990 - 12/1992	B 180 APC	B 180 EHD / B 160 EHD	B 185 APC	
TurboTech 190-32	01/1990 - 12/1992	B 180 APC	B 180 EHD / B 160 EHD	B 185 APC	
TurboTech 190-32 T	01/1990 - 12/1992	B 180 APC	B 180 EHD / B 160 EHD	B 185 APC	

MARCHIO E MODELLO - MAKE AND MODEL MARQUE ET MODÈLE - MARKE UND MODELL MARCA Y MODELO - МАРКА И МОДЕЛЬ	Periodo Period	powerCUBE		energyCUBE	
		APC	EHD	APC	RST
IVECO					
<i>cont.</i>					
TurboTech 190-36	01/1990 - 12/1992	B 180 APC	B 180 EHD / B 160 EHD	B 185 APC	
TurboTech 190-36 T	01/1990 - 12/1992	B 180 APC	B 180 EHD / B 160 EHD	B 185 APC	
TurboTech 220-36 PT	01/1990 - 12/1992	B 180 APC	B 180 EHD / B 160 EHD	B 185 APC	
TurboTech 240-36 P	01/1990 - 12/1992	B 180 APC	B 180 EHD / B 160 EHD	B 185 APC	
Zeta 109-14	06/1983 - 12/1985		D11 110 EHD / D11 135 EHD		
Zeta 109-14	11/1985 - 03/1991		D11 110 EHD / D11 135 EHD		
Zeta 109-14 H	06/1983 - 12/1985		D11 110 EHD / D11 135 EHD		
Zeta 109-14 H	11/1985 - 03/1991		D11 110 EHD / D11 135 EHD		
Zeta 79-10	01/1983 - 01/1987		D11 110 EHD / D11 135 EHD		
Zeta 79-10 H	01/1983 - 01/1987		D11 110 EHD / D11 135 EHD		
Zeta 79-10 V	01/1983 - 01/1987		D11 110 EHD / D11 135 EHD		
Zeta 79-12	01/1987 - 03/1991		D11 110 EHD / D11 135 EHD		
Zeta 79-12 H	01/1987 - 03/1991		D11 110 EHD / D11 135 EHD		
Zeta 79-12 V	01/1987 - 03/1991		D11 110 EHD / D11 135 EHD		
Zeta 79-13	11/1979 - 12/1983		D11 110 EHD / D11 135 EHD		
Zeta 79-14	01/1983 - 11/1985		D11 110 EHD / D11 135 EHD		
Zeta 79-14	12/1985 - 03/1991		D11 110 EHD / D11 135 EHD		
Zeta 79-14 H	01/1983 - 11/1985		D11 110 EHD / D11 135 EHD		
Zeta 79-14 H	12/1985 - 03/1991		D11 110 EHD / D11 135 EHD		
Zeta 79-14 V	01/1983 - 11/1985		D11 110 EHD / D11 135 EHD		
Zeta 79-14 V	12/1985 - 03/1991		D11 110 EHD / D11 135 EHD		
Zeta 95-14	07/1983 - 10/1985		D11 110 EHD / D11 135 EHD		
Zeta 95-14	11/1985 - 03/1991		D11 110 EHD / D11 135 EHD		
Zeta 95-14 H	07/1983 - 10/1985		D11 110 EHD / D11 135 EHD		
Zeta 95-14 H	11/1985 - 03/1991		D11 110 EHD / D11 135 EHD		
KIA					
PREGIO (TB) 2.5 TCI	09/2002 -				CB 110 RST
PREGIO (TB) 2.7 D	10/1997 -				CB 110 RST
LAND ROVER					
88/109 2.3 D (LR 88 DL, LR 109 DL)	09/1963 - 12/1986				CB 110 RST
DEFENDER (LD) 2.5 Td5 4WD	06/1998 -				CB 110 RST
DEFENDER Pick-up 2.5 Td5 4WD	06/1998 -				CB 110 RST
DEFENDER Station Wagon (LD) 2.5 Td5 4WD	06/1998 -				CB 110 RST
DISCOVERY II (LJ, LT) 2.5 Td5	01/1999 - 06/2004				CB 110 RST
RANGE ROVER II (LP) 2.5 D	07/1994 - 03/2002				CB 110 RST
RANGE ROVER II (LP) 2.5 D	08/1994 - 03/2002				CB 110 RST

MARCHIO E MODELLO - MAKE AND MODEL MARQUE ET MODÈLE - MARKE UND MODELL MARCA Y MODELO - МАРКА И МОДЕЛЬ	Periodo Period	powerCUBE		energyCUBE	
		APC	EHD	APC	RST
LAND ROVER <small>cont.</small>					
MAN					
CLA 15.220 FRC	01/2006 -	B 180 APC	B 180 EHD	B 185 APC	
CLA 16.220 FC	01/2006 -	B 180 APC	B 180 EHD	B 185 APC	
CLA 16.220 FK	01/2006 -	B 180 APC	B 180 EHD	B 185 APC	
CLA 18.280 FRC	01/2006 -	B 180 APC	B 180 EHD	B 185 APC	
CLA 18.280 FS	01/2006 -	B 180 APC	B 180 EHD	B 185 APC	
CLA 25.280 FDC	01/2006 -	B 180 APC	B 180 EHD	B 185 APC	
CLA 25.280 FDRS	01/2006 -	B 180 APC	B 180 EHD	B 185 APC	
CLA 26.280 FDC, FDRC	01/2006 -	B 180 APC	B 180 EHD	B 185 APC	
CLA 26.280 FDK, FDRK	01/2006 -	B 180 APC	B 180 EHD	B 185 APC	
CLA 26.280 FDS, FDRS	01/2006 -	B 180 APC	B 180 EHD	B 185 APC	
CLA 26.280 FD-TM, FDR-TM	01/2006 -	B 180 APC	B 180 EHD	B 185 APC	
E 2000 19.310 FALK	05/2000 -	B 180 APC	B 180 EHD / B 160 EHD	B 185 APC	
E 2000 19.310 FALS	05/2000 -	B 180 APC	B 180 EHD / B 160 EHD	B 185 APC	
E 2000 19.310 FLK	05/2000 -	B 180 APC	B 180 EHD / B 160 EHD	B 185 APC	
E 2000 19.310 FLS	05/2000 -	B 180 APC	B 180 EHD / B 160 EHD	B 185 APC	
E 2000 19.360 FALK	05/2000 -	B 180 APC	B 180 EHD / B 160 EHD	B 185 APC	
E 2000 19.360 FALS	05/2000 -	B 180 APC	B 180 EHD / B 160 EHD	B 185 APC	
E 2000 19.360 FLK	05/2000 -	B 180 APC	B 180 EHD / B 160 EHD	B 185 APC	
E 2000 19.360 FLS	05/2000 -	B 180 APC	B 180 EHD / B 160 EHD	B 185 APC	
E 2000 19.410 FALK	05/2000 -	B 180 APC	B 180 EHD / B 160 EHD	B 185 APC	
E 2000 19.410 FALS	05/2000 -	B 180 APC	B 180 EHD / B 160 EHD	B 185 APC	
E 2000 19.410 FLK	05/2000 -	B 180 APC	B 180 EHD / B 160 EHD	B 185 APC	
E 2000 19.410 FLS	05/2000 -	B 180 APC	B 180 EHD / B 160 EHD	B 185 APC	
E 2000 19.460 FALK	05/2000 -	B 180 APC	B 180 EHD / B 160 EHD	B 185 APC	
E 2000 19.460 FALS	05/2000 -	B 180 APC	B 180 EHD / B 160 EHD	B 185 APC	
E 2000 19.460 FLK	05/2000 -	B 180 APC	B 180 EHD / B 160 EHD	B 185 APC	
E 2000 19.460 FLS	05/2000 -	B 180 APC	B 180 EHD / B 160 EHD	B 185 APC	
E 2000 26.310 FAVLC	05/2000 -	B 180 APC	B 180 EHD / B 160 EHD	B 185 APC	
E 2000 26.310 FAVLK	05/2000 -	B 180 APC	B 180 EHD / B 160 EHD	B 185 APC	
E 2000 26.360 FAVLC	05/2000 -	B 180 APC	B 180 EHD / B 160 EHD	B 185 APC	
E 2000 26.360 FAVLK	05/2000 -	B 180 APC	B 180 EHD / B 160 EHD	B 185 APC	
E 2000 26.410 DFARC	05/2000 -	B 180 APC	B 180 EHD / B 160 EHD	B 185 APC	
E 2000 26.410 DFRC, FAVLC	05/2000 -	B 180 APC	B 180 EHD / B 160 EHD	B 185 APC	
E 2000 26.410 FAVLK	05/2000 -	B 180 APC	B 180 EHD / B 160 EHD	B 185 APC	
E 2000 26.460 DFARC	05/2000 -	B 180 APC	B 180 EHD / B 160 EHD	B 185 APC	
E 2000 26.460 DFLRS	05/2000 -	B 180 APC	B 180 EHD / B 160 EHD	B 185 APC	
E 2000 26.460 FAVLC	05/2000 -	B 180 APC	B 180 EHD / B 160 EHD	B 185 APC	
E 2000 26.460 FAVLK	05/2000 -	B 180 APC	B 180 EHD / B 160 EHD	B 185 APC	
E 2000 28.230 FNLC	05/2000 -	B 180 APC	B 180 EHD / B 160 EHD	B 185 APC	
E 2000 28.310 FNLC	05/2000 -	B 180 APC	B 180 EHD / B 160 EHD	B 185 APC	
E 2000 28.360 FANLC	05/2000 -	B 180 APC	B 180 EHD / B 160 EHD	B 185 APC	

MARCHIO E MODELLO - MAKE AND MODEL MARQUE ET MODÈLE - MARKE UND MODELL MARCA Y MODELO - МАРКА И МОДЕЛЬ	Periodo Period	powerCUBE		energyCUBE	
		APC	EHD	APC	RST
MAN <small>cont.</small>					
E 2000 28.360 FANLK	05/2000 -	B 180 APC	B 180 EHD / B 160 EHD	B 185 APC	
E 2000 28.360 FNALC	05/2000 -	B 180 APC	B 180 EHD / B 160 EHD	B 185 APC	
E 2000 28.360 FNLC	05/2000 -	B 180 APC	B 180 EHD / B 160 EHD	B 185 APC	
E 2000 28.410 FANLC	05/2000 -	B 180 APC	B 180 EHD / B 160 EHD	B 185 APC	
E 2000 28.410 FANLK	05/2000 -	B 180 APC	B 180 EHD / B 160 EHD	B 185 APC	
E 2000 28.410 FNLC	05/2000 -	B 180 APC	B 180 EHD / B 160 EHD	B 185 APC	
E 2000 28.460 FANLC	05/2000 -	B 180 APC	B 180 EHD / B 160 EHD	B 185 APC	
E 2000 28.460 FANLK	05/2000 -	B 180 APC	B 180 EHD / B 160 EHD	B 185 APC	
E 2000 28.460 FNLC	05/2000 -	B 180 APC	B 180 EHD / B 160 EHD	B 185 APC	
E 2000 29.460 FVAS	05/2000 -	B 180 APC	B 180 EHD / B 160 EHD	B 185 APC	
E 2000 30.310 FNLC	05/2000 -	B 180 APC	B 180 EHD / B 160 EHD	B 185 APC	
E 2000 30.360 FANLC	05/2000 -	B 180 APC	B 180 EHD / B 160 EHD	B 185 APC	
E 2000 30.360 FANLK	05/2000 -	B 180 APC	B 180 EHD / B 160 EHD	B 185 APC	
E 2000 30.360 FNLC	05/2000 -	B 180 APC	B 180 EHD / B 160 EHD	B 185 APC	
E 2000 30.410 FANLC	05/2000 -	B 180 APC	B 180 EHD / B 160 EHD	B 185 APC	
E 2000 30.410 FANLK	05/2000 -	B 180 APC	B 180 EHD / B 160 EHD	B 185 APC	
E 2000 30.410 FNLC	05/2000 -	B 180 APC	B 180 EHD / B 160 EHD	B 185 APC	
E 2000 30.460 FANLC	05/2000 -	B 180 APC	B 180 EHD / B 160 EHD	B 185 APC	
E 2000 30.460 FANLK	05/2000 -	B 180 APC	B 180 EHD / B 160 EHD	B 185 APC	
E 2000 30.460 FNLC	05/2000 -	B 180 APC	B 180 EHD / B 160 EHD	B 185 APC	
E 2000 32.310 VFLC	05/2000 -	B 180 APC	B 180 EHD / B 160 EHD	B 185 APC	
E 2000 32.310 VFNLC	05/2000 -	B 180 APC	B 180 EHD / B 160 EHD	B 185 APC	
E 2000 32.360 VFLC	05/2000 -	B 180 APC	B 180 EHD / B 160 EHD	B 185 APC	
E 2000 32.360 VFNLC	05/2000 -	B 180 APC	B 180 EHD / B 160 EHD	B 185 APC	
E 2000 32.410 VFARK	05/2000 -	B 180 APC	B 180 EHD / B 160 EHD	B 185 APC	
E 2000 32.410 VFLC,VFRC, VFLRC	05/2000 -	B 180 APC	B 180 EHD / B 160 EHD	B 185 APC	
E 2000 32.410 VFNLC	05/2000 -	B 180 APC	B 180 EHD / B 160 EHD	B 185 APC	
E 2000 32.460 VFLC, VFLRC	05/2000 -	B 180 APC	B 180 EHD / B 160 EHD	B 185 APC	
E 2000 32.460 VFNLC	05/2000 -	B 180 APC	B 180 EHD / B 160 EHD	B 185 APC	
E 2000 33.360 DFAK, DFALK	05/2000 -	B 180 APC	B 180 EHD / B 160 EHD	B 185 APC	
E 2000 33.360 DFALC	05/2000 -	B 180 APC	B 180 EHD / B 160 EHD	B 185 APC	
E 2000 33.360 DFALS	04/2001 -	B 180 APC	B 180 EHD / B 160 EHD	B 185 APC	
E 2000 33.360 DFCLC	05/2000 -	B 180 APC	B 180 EHD / B 160 EHD	B 185 APC	
E 2000 33.360 DFCLK	05/2000 -	B 180 APC	B 180 EHD / B 160 EHD	B 185 APC	
E 2000 33.360 DFCLS	05/2000 -	B 180 APC	B 180 EHD / B 160 EHD	B 185 APC	
E 2000 33.410 DFAK, DFALK	05/2000 -	B 180 APC	B 180 EHD / B 160 EHD	B 185 APC	
E 2000 33.410 DFALC	05/2000 -	B 180 APC	B 180 EHD / B 160 EHD	B 185 APC	
E 2000 33.410 DFALS	04/2001 -	B 180 APC	B 180 EHD / B 160 EHD	B 185 APC	
E 2000 33.410 DFCLC	05/2000 -	B 180 APC	B 180 EHD / B 160 EHD	B 185 APC	
E 2000 33.410 DFCLK	05/2000 -	B 180 APC	B 180 EHD / B 160 EHD	B 185 APC	
E 2000 33.410 DFCLS	05/2000 -	B 180 APC	B 180 EHD / B 160 EHD	B 185 APC	
E 2000 33.460 DFAK, DFALK	05/2000 -	B 180 APC	B 180 EHD / B 160 EHD	B 185 APC	
E 2000 33.460 DFALC	05/2000 -	B 180 APC	B 180 EHD / B 160 EHD	B 185 APC	
E 2000 33.460 DFALS	04/2001 -	B 180 APC	B 180 EHD / B 160 EHD	B 185 APC	
E 2000 33.460 DFCLC	05/2000 -	B 180 APC	B 180 EHD / B 160 EHD	B 185 APC	

MARCHIO E MODELLO - MAKE AND MODEL MARQUE ET MODÈLE - MARKE UND MODELL MARCA Y MODELO - МАРКА И МОДЕЛЬ	Periodo Period	powerCUBE		energyCUBE	
		APC	EHD	APC	RST
MAN					
<i>cont.</i>					
E 2000 33.460 DFLK	05/2000 -	B 180 APC	B 180 EHD / B 160 EHD	B 185 APC	
E 2000 33.460 DFLS	05/2000 -	B 180 APC	B 180 EHD / B 160 EHD	B 185 APC	
E 2000 33.600 DFALS, DFAS	06/2000 -	B 180 APC	B 180 EHD / B 160 EHD	B 185 APC	
E 2000 33.600 DFLS	06/2000 -	B 180 APC	B 180 EHD / B 160 EHD	B 185 APC	
E 2000 35.360 VFAK	05/2000 -	B 180 APC	B 180 EHD / B 160 EHD	B 185 APC	
E 2000 35.410 FVNLC	05/2000 -	B 180 APC	B 180 EHD / B 160 EHD	B 185 APC	
E 2000 35.410 VFAK	05/2000 -	B 180 APC	B 180 EHD / B 160 EHD	B 185 APC	
E 2000 35.460 FVNLC	05/2000 -	B 180 APC	B 180 EHD / B 160 EHD	B 185 APC	
E 2000 35.460 VFAK	05/2000 -	B 180 APC	B 180 EHD / B 160 EHD	B 185 APC	
E 2000 40.600 DFAS	06/2000 -	B 180 APC	B 180 EHD / B 160 EHD	B 185 APC	
E 2000 41.360 VFAK	05/2000 -	B 180 APC	B 180 EHD / B 160 EHD	B 185 APC	
E 2000 41.410 VFAK	05/2000 -	B 180 APC	B 180 EHD / B 160 EHD	B 185 APC	
E 2000 41.460 DFVS, DFVLS	06/2000 -	B 180 APC	B 180 EHD / B 160 EHD	B 185 APC	
E 2000 41.460 VFAK	05/2000 -	B 180 APC	B 180 EHD / B 160 EHD	B 185 APC	
E 2000 41.600 DFVS, DFVLS	06/2000 -	B 180 APC	B 180 EHD / B 160 EHD	B 185 APC	
E 2000 50.410 VFAK	05/2000 -	B 180 APC	B 180 EHD / B 160 EHD	B 185 APC	
E 2000 50.410 VFAVK	03/2001 -	B 180 APC	B 180 EHD / B 160 EHD	B 185 APC	
E 2000 50.410 VFK	05/2000 -	B 180 APC	B 180 EHD / B 160 EHD	B 185 APC	
E 2000 50.410 VFVK	10/2000 -	B 180 APC	B 180 EHD / B 160 EHD	B 185 APC	
E 2000 50.460 VFAK	05/2000 -	B 180 APC	B 180 EHD / B 160 EHD	B 185 APC	
E 2000 50.460 VFAVK	03/2001 -	B 180 APC	B 180 EHD / B 160 EHD	B 185 APC	
E 2000 50.460 VFK	05/2000 -	B 180 APC	B 180 EHD / B 160 EHD	B 185 APC	
E 2000 50.460 VFVK	10/2000 -	B 180 APC	B 180 EHD / B 160 EHD	B 185 APC	
E 2000 50.600 VFAS	05/2000 -	B 180 APC	B 180 EHD / B 160 EHD	B 185 APC	
EL EL 202,EL 222	01/1993 - 06/1997	CX 225 APC	CX 200 EHD	CX 220 APC	
EL EL 202,EL 262	04/1994 - 06/1997	CX 225 APC	CX 200 EHD	CX 220 APC	
EL EL 262	07/1998 -	CX 225 APC	CX 200 EHD	CX 220 APC	
EM EM 192	10/1993 - 06/1997	B 180 APC	B 180 EHD / B 160 EHD	B 185 APC	
EM EM 222,EM 223	02/1996 -	B 180 APC	B 180 EHD / B 160 EHD	B 185 APC	
EM EM 223	08/1987 -	B 180 APC	B 180 EHD / B 160 EHD	B 185 APC	
F 2000 18.273 F, FL, FLL	06/1994 -	B 180 APC	B 180 EHD	B 185 APC	
F 2000 19.233 FCNG	09/1996 -	B 180 APC	B 180 EHD / B 160 EHD	B 185 APC	
F 2000 19.233 FKNG	03/2000 -	B 180 APC	B 180 EHD / B 160 EHD	B 185 APC	
F 2000 19.273 F,19.273 FL,19.273 FLL	01/1994 - 12/1995	B 180 APC	B 180 EHD / B 160 EHD	B 185 APC	
F 2000 19.273 FA	01/1994 - 12/1995	B 180 APC	B 180 EHD / B 160 EHD	B 185 APC	
F 2000 19.273 FAK	01/1994 - 12/1995	B 180 APC	B 180 EHD / B 160 EHD	B 185 APC	
F 2000 19.273 FK	01/1994 - 12/1995	B 180 APC	B 180 EHD / B 160 EHD	B 185 APC	
F 2000 19.273 FS,19.273 FLS	01/1994 - 12/1995	B 180 APC	B 180 EHD / B 160 EHD	B 185 APC	
F 2000 19.293 FAC	01/1994 -	B 180 APC	B 180 EHD / B 160 EHD	B 185 APC	
F 2000 19.293 FAK	01/1994 -	B 180 APC	B 180 EHD / B 160 EHD	B 185 APC	
F 2000 19.293 FAS	01/1994 -	B 180 APC	B 180 EHD / B 160 EHD	B 185 APC	
F 2000 19.293 FC,19.293 FLC,19.293 FLLC	01/1994 -	B 180 APC	B 180 EHD / B 160 EHD	B 185 APC	
F 2000 19.293 FK,19.293 FLK	01/1994 -	B 180 APC	B 180 EHD / B 160 EHD	B 185 APC	
F 2000 19.293 FS,19.293 FLS,19.293 FLLS	01/1994 -	B 180 APC	B 180 EHD / B 160 EHD	B 185 APC	
F 2000 19.314 FAC	05/2001 -	B 180 APC	B 180 EHD / B 160 EHD	B 185 APC	

MARCHIO E MODELLO - MAKE AND MODEL MARQUE ET MODÈLE - MARKE UND MODELL MARCA Y MODELO - МАРКА И МОДЕЛЬ	Periodo Period	powerCUBE		energyCUBE	
		APC	EHD	APC	RST
MAN					
<i>cont.</i>					
F 2000 19.314 FAK, FA-KI	05/2001 -	B 180 APC	B 180 EHD / B 160 EHD	B 185 APC	
F 2000 19.314 FAS	06/1998 -	B 180 APC	B 180 EHD / B 160 EHD	B 185 APC	
F 2000 19.314 FC,19.314 FLC,19.314 FLLC	06/1998 -	B 180 APC	B 180 EHD / B 160 EHD	B 185 APC	
F 2000 19.314 FK,19.314 FLK	06/1998 -	B 180 APC	B 180 EHD / B 160 EHD	B 185 APC	
F 2000 19.314 FS,19.314 FLS,19.314 FLLS	06/1998 -	B 180 APC	B 180 EHD / B 160 EHD	B 185 APC	
F 2000 19.323 FAC	01/1994 - 12/1995	B 180 APC	B 180 EHD / B 160 EHD	B 185 APC	
F 2000 19.323 FAK	01/1994 - 12/1995	B 180 APC	B 180 EHD / B 160 EHD	B 185 APC	
F 2000 19.323 FAS	01/1994 - 12/1995	B 180 APC	B 180 EHD / B 160 EHD	B 185 APC	
F 2000 19.323 FC,19.323 FLC,19.323 FLLC	01/1994 - 12/1995	B 180 APC	B 180 EHD / B 160 EHD	B 185 APC	
F 2000 19.323 FK,19.323 FLK	01/1994 - 12/1995	B 180 APC	B 180 EHD / B 160 EHD	B 185 APC	
F 2000 19.323 FS,19.323 FLS,19.323 FLLS	01/1994 - 12/1995	B 180 APC	B 180 EHD / B 160 EHD	B 185 APC	
F 2000 19.343 FAC	01/1994 -	B 180 APC	B 180 EHD / B 160 EHD	B 185 APC	
F 2000 19.343 FAK	01/1994 -	B 180 APC	B 180 EHD / B 160 EHD	B 185 APC	
F 2000 19.343 FAS	01/1994 -	B 180 APC	B 180 EHD / B 160 EHD	B 185 APC	
F 2000 19.343 FC,19.343 FLC,19.343 FLLC	01/1994 -	B 180 APC	B 180 EHD / B 160 EHD	B 185 APC	
F 2000 19.343 FK,19.343 FLK	01/1994 -	B 180 APC	B 180 EHD / B 160 EHD	B 185 APC	
F 2000 19.343 FS,19.343 FLS,19.343 FLLS	01/1994 -	B 180 APC	B 180 EHD / B 160 EHD	B 185 APC	
F 2000 19.364 FAC	06/1998 -	B 180 APC	B 180 EHD / B 160 EHD	B 185 APC	
F 2000 19.364 FAK	06/1998 -	B 180 APC	B 180 EHD / B 160 EHD	B 185 APC	
F 2000 19.364 FAS	06/1998 -	B 180 APC	B 180 EHD / B 160 EHD	B 185 APC	
F 2000 19.364 FC,19.364 FLC,19.364 FLLC	06/1998 -	B 180 APC	B 180 EHD / B 160 EHD	B 185 APC	
F 2000 19.364 FK,19.364 FLK	06/1998 -	B 180 APC	B 180 EHD / B 160 EHD	B 185 APC	
F 2000 19.364 FS,19.364 FLS,19.364 FLLS	06/1998 -	B 180 APC	B 180 EHD / B 160 EHD	B 185 APC	
F 2000 19.373 FAC	01/1994 - 12/1995	B 180 APC	B 180 EHD / B 160 EHD	B 185 APC	
F 2000 19.373 FAK	01/1994 - 12/1995	B 180 APC	B 180 EHD / B 160 EHD	B 185 APC	
F 2000 19.373 FAS	01/1994 - 12/1995	B 180 APC	B 180 EHD / B 160 EHD	B 185 APC	
F 2000 19.373 FC,19.373 FLC,19.373 FLLC	01/1994 - 12/1995	B 180 APC	B 180 EHD / B 160 EHD	B 185 APC	
F 2000 19.373 FK,19.373 FLK	01/1994 - 12/1995	B 180 APC	B 180 EHD / B 160 EHD	B 185 APC	
F 2000 19.373 FS,19.373 FLS,19.373 FLLS	01/1994 - 12/1995	B 180 APC	B 180 EHD / B 160 EHD	B 185 APC	
F 2000 19.403 FAC	01/1994 -	B 180 APC	B 180 EHD / B 160 EHD	B 185 APC	
F 2000 19.403 FAK	01/1994 -	B 180 APC	B 180 EHD / B 160 EHD	B 185 APC	
F 2000 19.403 FAS	01/1994 -	B 180 APC	B 180 EHD / B 160 EHD	B 185 APC	
F 2000 19.403 FC,19.403 FLC,19.403 FLLC	01/1994 -	B 180 APC	B 180 EHD / B 160 EHD	B 185 APC	
F 2000 19.403 FK,19.403 FLK	01/1994 -	B 180 APC	B 180 EHD / B 160 EHD	B 185 APC	
F 2000 19.403 FS,19.403 FLS,19.403 FLLS	01/1994 -	B 180 APC	B 180 EHD / B 160 EHD	B 185 APC	
F 2000 19.414 FAC	06/1998 -	B 180 APC	B 180 EHD / B 160 EHD	B 185 APC	
F 2000 19.414 FAK	06/1998 -	B 180 APC	B 180 EHD / B 160 EHD	B 185 APC	
F 2000 19.414 FAS	06/1998 -	B 180 APC	B 180 EHD / B 160 EHD	B 185 APC	
F 2000 19.414 FC,19.414 FLC,19.414 FLLC	06/1998 -	B 180 APC	B 180 EHD / B 160 EHD	B 185 APC	
F 2000 19.414 FK,19.414 FLK	06/1998 -	B 180 APC	B 180 EHD / B 160 EHD	B 185 APC	
F 2000 19.414 FS,19.414 FLS,19.414 FLLS	06/1998 -	B 180 APC	B 180 EHD / B 160 EHD	B 185 APC	
F 2000 19.423 FAC	01/1994 - 12/1995	B 180 APC	B 180 EHD / B 160 EHD	B 185 APC	
F 2000 19.423 FAK	01/1994 - 12/1995	B 180 APC	B 180 EHD / B 160 EHD	B 185 APC	
F 2000 19.423 FAS	01/1994 - 12/1995	B 180 APC	B 180 EHD / B 160 EHD	B 185 APC	
F 2000 19.423 FC,19.423 FLC,19.423 FLLC	01/1994 - 12/1995	B 180 APC	B 180 EHD / B 160 EHD	B 185 APC	

MARCHIO E MODELLO - MAKE AND MODEL MARQUE ET MODÈLE - MARKE UND MODELL MARCA Y MODELO - МАРКА И МОДЕЛЬ	Periodo Period	powerCUBE		energyCUBE	
		APC	EHD	APC	RST
MAN					
cont.					
F 2000 19.423 FK,19.423 FLK	01/1994 - 12/1995	B 180 APC	B 180 EHD / B 160 EHD	B 185 APC	
F 2000 19.423 FS,19.423 FLS,19.423 FLLS	01/1994 - 12/1995	B 180 APC	B 180 EHD / B 160 EHD	B 185 APC	
F 2000 19.463 FAC	01/1994 -	B 180 APC	B 180 EHD / B 160 EHD	B 185 APC	
F 2000 19.463 FAK	01/1994 -	B 180 APC	B 180 EHD / B 160 EHD	B 185 APC	
F 2000 19.463 FAS	01/1994 -	B 180 APC	B 180 EHD / B 160 EHD	B 185 APC	
F 2000 19.463 FC,19.463 FLC,19.463 FLLC	01/1994 -	B 180 APC	B 180 EHD / B 160 EHD	B 185 APC	
F 2000 19.463 FK,19.463 FLK	01/1994 -	B 180 APC	B 180 EHD / B 160 EHD	B 185 APC	
F 2000 19.463 FS,19.463 FLS,19.463 FLLS	01/1994 -	B 180 APC	B 180 EHD / B 160 EHD	B 185 APC	
F 2000 19.464 FAC	06/1998 -	B 180 APC	B 180 EHD / B 160 EHD	B 185 APC	
F 2000 19.464 FAK	06/1998 -	B 180 APC	B 180 EHD / B 160 EHD	B 185 APC	
F 2000 19.464 FAS	06/1998 -	B 180 APC	B 180 EHD / B 160 EHD	B 185 APC	
F 2000 19.464 FC,19.464 FLC,19.464 FLLC	06/1998 -	B 180 APC	B 180 EHD / B 160 EHD	B 185 APC	
F 2000 19.464 FK,19.464 FLK	06/1998 -	B 180 APC	B 180 EHD / B 160 EHD	B 185 APC	
F 2000 19.464 FS,19.464 FLS,19.464 FLLS	06/1998 -	B 180 APC	B 180 EHD / B 160 EHD	B 185 APC	
F 2000 19.603 FLS	04/1996 -	B 180 APC	B 180 EHD / B 160 EHD	B 185 APC	
F 2000 23.293 FNLLC	01/1994 -	B 180 APC	B 180 EHD / B 160 EHD	B 185 APC	
F 2000 23.314 FNLLC	05/2001 -	B 180 APC	B 180 EHD / B 160 EHD	B 185 APC	
F 2000 23.343 FNLLC	01/1994 -	B 180 APC	B 180 EHD / B 160 EHD	B 185 APC	
F 2000 23.364 FNLLC	05/2001 -	B 180 APC	B 180 EHD / B 160 EHD	B 185 APC	
F 2000 23.403 FNLLC	01/1994 -	B 180 APC	B 180 EHD / B 160 EHD	B 185 APC	
F 2000 23.414 FNLLC	05/2001 -	B 180 APC	B 180 EHD / B 160 EHD	B 185 APC	
F 2000 23.463 FNLLC	01/1994 -	B 180 APC	B 180 EHD / B 160 EHD	B 185 APC	
F 2000 23.464 FNLLC	05/2001 -	B 180 APC	B 180 EHD / B 160 EHD	B 185 APC	
F 2000 24.273 FNLLC	01/1994 - 12/1995	B 180 APC	B 180 EHD / B 160 EHD	B 185 APC	
F 2000 24.293 FNLLC	01/1994 -	B 180 APC	B 180 EHD / B 160 EHD	B 185 APC	
F 2000 24.314 FNLLRC	05/2001 -	B 180 APC	B 180 EHD / B 160 EHD	B 185 APC	
F 2000 24.323 FNLLC	01/1994 - 12/1995	B 180 APC	B 180 EHD / B 160 EHD	B 185 APC	
F 2000 24.343 FNLLC	01/1994 -	B 180 APC	B 180 EHD / B 160 EHD	B 185 APC	
F 2000 24.364 FNLLRC	05/2001 -	B 180 APC	B 180 EHD / B 160 EHD	B 185 APC	
F 2000 24.373 FNLLC	01/1994 - 12/1995	B 180 APC	B 180 EHD / B 160 EHD	B 185 APC	
F 2000 24.403 FNLLC	01/1994 -	B 180 APC	B 180 EHD / B 160 EHD	B 185 APC	
F 2000 24.414 FNLLRC	05/2001 -	B 180 APC	B 180 EHD / B 160 EHD	B 185 APC	
F 2000 24.423 FNLLC	01/1994 - 12/1995	B 180 APC	B 180 EHD / B 160 EHD	B 185 APC	
F 2000 24.463 FNLLC	01/1994 -	B 180 APC	B 180 EHD / B 160 EHD	B 185 APC	
F 2000 24.464 FNLLRC	05/2001 -	B 180 APC	B 180 EHD / B 160 EHD	B 185 APC	
F 2000 26.233 FVLCNG	09/1996 -	B 180 APC	B 180 EHD / B 160 EHD	B 185 APC	
F 2000 26.233 FVL-KO	03/2000 -	B 180 APC	B 180 EHD / B 160 EHD	B 185 APC	
F 2000 26.273 DFC,26.273 DFLC	01/1994 - 12/1995	B 180 APC	B 180 EHD / B 160 EHD	B 185 APC	
F 2000 26.273 DFK,26.273 DFLK	01/1994 - 12/1995	B 180 APC	B 180 EHD / B 160 EHD	B 185 APC	
F 2000 26.273 DFS,26.273 DFLS	01/1994 - 12/1995	B 180 APC	B 180 EHD / B 160 EHD	B 185 APC	
F 2000 26.273 FNLC,26.273 FNLLC,26.273 FVLC	01/1994 - 12/1995	B 180 APC	B 180 EHD / B 160 EHD	B 185 APC	
F 2000 26.273 FNLS,26.273 FVLS	01/1994 - 12/1995	B 180 APC	B 180 EHD / B 160 EHD	B 185 APC	
F 2000 26.293 DFC,26.293 DFLC	01/1994 -	B 180 APC	B 180 EHD / B 160 EHD	B 185 APC	
F 2000 26.293 DFK,26.293 DFLK	01/1994 -	B 180 APC	B 180 EHD / B 160 EHD	B 185 APC	
F 2000 26.293 DFS,26.293 DFLS	01/1994 -	B 180 APC	B 180 EHD / B 160 EHD	B 185 APC	

MARCHIO E MODELLO - MAKE AND MODEL MARQUE ET MODÈLE - MARKE UND MODELL MARCA Y MODELO - МАРКА И МОДЕЛЬ	Periodo Period	powerCUBE		energyCUBE	
		APC	EHD	APC	RST
MAN					
<i>cont.</i>					
F 2000 26.293 FNLC,26.293 FNLLC,26.293 FVLC	01/1994 -	B 180 APC	B 180 EHD / B 160 EHD	B 185 APC	
F 2000 26.293 FNLS,26.293 FVLS	01/1994 -	B 180 APC	B 180 EHD / B 160 EHD	B 185 APC	
F 2000 26.314 DFC, DFLC	05/2001 -	B 180 APC	B 180 EHD / B 160 EHD	B 185 APC	
F 2000 26.314 DFK, DFLK	05/2001 -	B 180 APC	B 180 EHD / B 160 EHD	B 185 APC	
F 2000 26.314 DFS, DFLS	05/2001 -	B 180 APC	B 180 EHD / B 160 EHD	B 185 APC	
F 2000 26.314 DF-TM	05/2001 -	B 180 APC	B 180 EHD / B 160 EHD	B 185 APC	
F 2000 26.314 FNLC, FNLLC, FNLLRC, FNLLW, FVLC	05/2001 -	B 180 APC	B 180 EHD / B 160 EHD	B 185 APC	
F 2000 26.314 FNLS	05/2001 -	B 180 APC	B 180 EHD / B 160 EHD	B 185 APC	
F 2000 26.314 FVL-KO	05/2001 -	B 180 APC	B 180 EHD / B 160 EHD	B 185 APC	
F 2000 26.314 FVLS, FVLSRS	05/2001 -	B 180 APC	B 180 EHD / B 160 EHD	B 185 APC	
F 2000 26.323 DFC,26.323 DFLC	01/1994 - 12/1995	B 180 APC	B 180 EHD / B 160 EHD	B 185 APC	
F 2000 26.323 DFK,26.323 DFLK	01/1994 - 12/1995	B 180 APC	B 180 EHD / B 160 EHD	B 185 APC	
F 2000 26.323 DFS,26.323 DFLS	01/1994 - 12/1995	B 180 APC	B 180 EHD / B 160 EHD	B 185 APC	
F 2000 26.323 FNLC,26.323 FNLLC,26.323 FVLC	01/1994 - 12/1995	B 180 APC	B 180 EHD / B 160 EHD	B 185 APC	
F 2000 26.323 FNLS,26.323 FVLS	01/1994 - 12/1995	B 180 APC	B 180 EHD / B 160 EHD	B 185 APC	
F 2000 26.343 DFC,26.343 DFLC	01/1994 -	B 180 APC	B 180 EHD / B 160 EHD	B 185 APC	
F 2000 26.343 DFK,26.343 DFLK	01/1994 -	B 180 APC	B 180 EHD / B 160 EHD	B 185 APC	
F 2000 26.343 DFS,26.343 DFLS	01/1994 -	B 180 APC	B 180 EHD / B 160 EHD	B 185 APC	
F 2000 26.343 FNLC,26.343 FNLLC,26.343 FVLC	01/1994 -	B 180 APC	B 180 EHD / B 160 EHD	B 185 APC	
F 2000 26.343 FNLS,26.343 FVLS	01/1994 -	B 180 APC	B 180 EHD / B 160 EHD	B 185 APC	
F 2000 26.364 DFC, DFLC	05/2001 -	B 180 APC	B 180 EHD / B 160 EHD	B 185 APC	
F 2000 26.364 DFK, DFLK	05/2001 -	B 180 APC	B 180 EHD / B 160 EHD	B 185 APC	
F 2000 26.364 DFS, DFLS	05/2001 -	B 180 APC	B 180 EHD / B 160 EHD	B 185 APC	
F 2000 26.364 DF-TM	05/2001 -	B 180 APC	B 180 EHD / B 160 EHD	B 185 APC	
F 2000 26.364 FNLC, FNLLC, FNLLRC, FNLLW, FVLC	05/2001 -	B 180 APC	B 180 EHD / B 160 EHD	B 185 APC	
F 2000 26.364 FNLS	05/2001 -	B 180 APC	B 180 EHD / B 160 EHD	B 185 APC	
F 2000 26.364 FVL-KO	05/2001 -	B 180 APC	B 180 EHD / B 160 EHD	B 185 APC	
F 2000 26.364 FVLS, FVLSRS	05/2001 -	B 180 APC	B 180 EHD / B 160 EHD	B 185 APC	
F 2000 26.373 DFC,26.373 DFLC	01/1994 - 12/1995	B 180 APC	B 180 EHD / B 160 EHD	B 185 APC	
F 2000 26.373 DFK,26.373 DFLK	01/1994 - 12/1995	B 180 APC	B 180 EHD / B 160 EHD	B 185 APC	
F 2000 26.373 DFS,26.373 DFLS	01/1994 - 12/1995	B 180 APC	B 180 EHD / B 160 EHD	B 185 APC	
F 2000 26.373 FNLC,26.373 FNLLC,26.373 FVLC	01/1994 - 12/1995	B 180 APC	B 180 EHD / B 160 EHD	B 185 APC	
F 2000 26.373 FNLS,26.373 FVLS	01/1994 - 12/1995	B 180 APC	B 180 EHD / B 160 EHD	B 185 APC	
F 2000 26.403 DFC,26.403 DFLC	01/1994 -	B 180 APC	B 180 EHD / B 160 EHD	B 185 APC	
F 2000 26.403 DFK,26.403 DFLK	01/1994 -	B 180 APC	B 180 EHD / B 160 EHD	B 185 APC	
F 2000 26.403 DFS,26.403 DFLS	01/1994 -	B 180 APC	B 180 EHD / B 160 EHD	B 185 APC	
F 2000 26.403 FNLC,26.403 FNLLC,26.403 FVLC	01/1994 -	B 180 APC	B 180 EHD / B 160 EHD	B 185 APC	
F 2000 26.403 FNLS,26.403 FVLS	01/1994 -	B 180 APC	B 180 EHD / B 160 EHD	B 185 APC	
F 2000 26.414 DFC, DFLC	05/2001 -	B 180 APC	B 180 EHD / B 160 EHD	B 185 APC	
F 2000 26.414 DFK, DFLK	05/2001 -	B 180 APC	B 180 EHD / B 160 EHD	B 185 APC	
F 2000 26.414 DFS, DFLS	05/2001 -	B 180 APC	B 180 EHD / B 160 EHD	B 185 APC	
F 2000 26.414 DF-TM	05/2001 -	B 180 APC	B 180 EHD / B 160 EHD	B 185 APC	
F 2000 26.414 FNLC, FNLLC, FNLLRC, FNLLW, FVLC	05/2001 -	B 180 APC	B 180 EHD / B 160 EHD	B 185 APC	
F 2000 26.414 FNLS	05/2001 -	B 180 APC	B 180 EHD / B 160 EHD	B 185 APC	
F 2000 26.414 FVL-KO	05/2001 -	B 180 APC	B 180 EHD / B 160 EHD	B 185 APC	

MARCHIO E MODELLO - MAKE AND MODEL MARQUE ET MODÈLE - MARKE UND MODELL MARCA Y MODELO - МАРКА И МОДЕЛЬ	Periodo Period	powerCUBE		energyCUBE	
		APC	EHD	APC	RST
MAN cont.					
F 2000 26.414 FVLS, FVLRS	05/2001 -	B 180 APC	B 180 EHD / B 160 EHD	B 185 APC	
F 2000 26.423 DFC,26.423 DFCLC	01/1994 - 12/1995	B 180 APC	B 180 EHD / B 160 EHD	B 185 APC	
F 2000 26.423 DFK,26.423 DFLK	01/1994 - 12/1995	B 180 APC	B 180 EHD / B 160 EHD	B 185 APC	
F 2000 26.423 DFS,26.423 DFSL	01/1994 - 12/1995	B 180 APC	B 180 EHD / B 160 EHD	B 185 APC	
F 2000 26.423 FNLC,26.423 FNLLC,26.423 FVLC	01/1994 - 12/1995	B 180 APC	B 180 EHD / B 160 EHD	B 185 APC	
F 2000 26.423 FNLS,26.423 FVLS	01/1994 - 12/1995	B 180 APC	B 180 EHD / B 160 EHD	B 185 APC	
F 2000 26.463 DFC,26.463 DFCLC	01/1994 -	B 180 APC	B 180 EHD / B 160 EHD	B 185 APC	
F 2000 26.463 DFK,26.463 DFLK	01/1994 -	B 180 APC	B 180 EHD / B 160 EHD	B 185 APC	
F 2000 26.463 DFS,26.463 DFSL	01/1994 -	B 180 APC	B 180 EHD / B 160 EHD	B 185 APC	
F 2000 26.463 FNLC,26.463 FNLLC,26.463 FVLC	01/1994 -	B 180 APC	B 180 EHD / B 160 EHD	B 185 APC	
F 2000 26.463 FNLS,26.463 FVLS	01/1994 -	B 180 APC	B 180 EHD / B 160 EHD	B 185 APC	
F 2000 26.464 DFC, DFCLC	05/2001 -	B 180 APC	B 180 EHD / B 160 EHD	B 185 APC	
F 2000 26.464 DFK, DFLK	05/2001 -	B 180 APC	B 180 EHD / B 160 EHD	B 185 APC	
F 2000 26.464 DFS, DFSL	05/2001 -	B 180 APC	B 180 EHD / B 160 EHD	B 185 APC	
F 2000 26.464 DF-TM	05/2001 -	B 180 APC	B 180 EHD / B 160 EHD	B 185 APC	
F 2000 26.464 FNLC, FNLLC, FNLLW, FVLC	05/2001 -	B 180 APC	B 180 EHD / B 160 EHD	B 185 APC	
F 2000 26.464 FNLS	05/2001 -	B 180 APC	B 180 EHD / B 160 EHD	B 185 APC	
F 2000 26.464 FVL-KO	05/2001 -	B 180 APC	B 180 EHD / B 160 EHD	B 185 APC	
F 2000 26.464 FVLS, FVLRS	05/2001 -	B 180 APC	B 180 EHD / B 160 EHD	B 185 APC	
F 2000 26.603 DFC,26.603 DFCLC	06/1996 -	B 180 APC	B 180 EHD / B 160 EHD	B 185 APC	
F 2000 26.603 DFK,26.603 DFLK	06/1996 -	B 180 APC	B 180 EHD / B 160 EHD	B 185 APC	
F 2000 26.603 DFS,26.603 DFSL	06/1996 -	B 180 APC	B 180 EHD / B 160 EHD	B 185 APC	
F 2000 26.604 DFSL	04/2000 -	B 180 APC	B 180 EHD / B 160 EHD	B 185 APC	
F 2000 27.273 DFAC	01/1994 - 12/1995	B 180 APC	B 180 EHD / B 160 EHD	B 185 APC	
F 2000 27.273 DFAK	01/1994 - 12/1995	B 180 APC	B 180 EHD / B 160 EHD	B 185 APC	
F 2000 27.273 DFAS	01/1994 - 12/1995	B 180 APC	B 180 EHD / B 160 EHD	B 185 APC	
F 2000 27.273 DFC	01/1994 - 12/1995	B 180 APC	B 180 EHD / B 160 EHD	B 185 APC	
F 2000 27.273 DFK	01/1994 - 12/1995	B 180 APC	B 180 EHD / B 160 EHD	B 185 APC	
F 2000 27.273 DFS	01/1994 - 12/1995	B 180 APC	B 180 EHD / B 160 EHD	B 185 APC	
F 2000 27.293 DFAC	01/1994 -	B 180 APC	B 180 EHD / B 160 EHD	B 185 APC	
F 2000 27.293 DFAK	01/1994 -	B 180 APC	B 180 EHD / B 160 EHD	B 185 APC	
F 2000 27.293 DFAS	01/1994 -	B 180 APC	B 180 EHD / B 160 EHD	B 185 APC	
F 2000 27.293 DFC	01/1994 -	B 180 APC	B 180 EHD / B 160 EHD	B 185 APC	
F 2000 27.293 DFK	01/1994 -	B 180 APC	B 180 EHD / B 160 EHD	B 185 APC	
F 2000 27.293 DFS	01/1994 -	B 180 APC	B 180 EHD / B 160 EHD	B 185 APC	
F 2000 27.314 DFAC	05/2001 -	B 180 APC	B 180 EHD / B 160 EHD	B 185 APC	
F 2000 27.314 DFAK, DFA-KI	05/2001 -	B 180 APC	B 180 EHD / B 160 EHD	B 185 APC	
F 2000 27.314 DFAS	05/2001 -	B 180 APC	B 180 EHD / B 160 EHD	B 185 APC	
F 2000 27.314 DFC	05/2001 -	B 180 APC	B 180 EHD / B 160 EHD	B 185 APC	
F 2000 27.314 DFK, DF-KI	05/2001 -	B 180 APC	B 180 EHD / B 160 EHD	B 185 APC	
F 2000 27.314 DFS	05/2001 -	B 180 APC	B 180 EHD / B 160 EHD	B 185 APC	
F 2000 27.314 DF-TM	05/2001 -	B 180 APC	B 180 EHD / B 160 EHD	B 185 APC	
F 2000 27.314 FVL	06/1998 -	B 180 APC	B 180 EHD / B 160 EHD	B 185 APC	
F 2000 27.323 DFAC	01/1994 - 12/1995	B 180 APC	B 180 EHD / B 160 EHD	B 185 APC	
F 2000 27.323 DFAK	01/1994 - 12/1995	B 180 APC	B 180 EHD / B 160 EHD	B 185 APC	

MARCHIO E MODELLO - MAKE AND MODEL MARQUE ET MODÈLE - MARKE UND MODELL MARCA Y MODELO - МАРКА И МОДЕЛЬ	Periodo Period	powerCUBE		energyCUBE	
		APC	EHD	APC	RST
MAN					
	cont.				
F 2000 27.323 DFAS	01/1994 - 12/1995	B 180 APC	B 180 EHD / B 160 EHD	B 185 APC	
F 2000 27.323 DFC	01/1994 - 12/1995	B 180 APC	B 180 EHD / B 160 EHD	B 185 APC	
F 2000 27.323 DFK	01/1994 - 12/1995	B 180 APC	B 180 EHD / B 160 EHD	B 185 APC	
F 2000 27.323 DFS	01/1994 - 12/1995	B 180 APC	B 180 EHD / B 160 EHD	B 185 APC	
F 2000 27.343 DFAC	01/1994 -	B 180 APC	B 180 EHD / B 160 EHD	B 185 APC	
F 2000 27.343 DFAK	01/1994 -	B 180 APC	B 180 EHD / B 160 EHD	B 185 APC	
F 2000 27.343 DFAS	01/1994 -	B 180 APC	B 180 EHD / B 160 EHD	B 185 APC	
F 2000 27.343 DFC	01/1994 -	B 180 APC	B 180 EHD / B 160 EHD	B 185 APC	
F 2000 27.343 DFK	01/1994 -	B 180 APC	B 180 EHD / B 160 EHD	B 185 APC	
F 2000 27.343 DFS	01/1994 -	B 180 APC	B 180 EHD / B 160 EHD	B 185 APC	
F 2000 27.364 DFAC	05/2001 -	B 180 APC	B 180 EHD / B 160 EHD	B 185 APC	
F 2000 27.364 DFAK, DFA-KI	05/2001 -	B 180 APC	B 180 EHD / B 160 EHD	B 185 APC	
F 2000 27.364 DFAS	05/2001 -	B 180 APC	B 180 EHD / B 160 EHD	B 185 APC	
F 2000 27.364 DFC	05/2001 -	B 180 APC	B 180 EHD / B 160 EHD	B 185 APC	
F 2000 27.364 DFK, DF-KI	05/2001 -	B 180 APC	B 180 EHD / B 160 EHD	B 185 APC	
F 2000 27.364 DFS	05/2001 -	B 180 APC	B 180 EHD / B 160 EHD	B 185 APC	
F 2000 27.364 DF-TM	05/2001 -	B 180 APC	B 180 EHD / B 160 EHD	B 185 APC	
F 2000 27.364 FVL	06/1998 -	B 180 APC	B 180 EHD / B 160 EHD	B 185 APC	
F 2000 27.373 DFAC	01/1994 - 12/1995	B 180 APC	B 180 EHD / B 160 EHD	B 185 APC	
F 2000 27.373 DFAK	01/1994 - 12/1995	B 180 APC	B 180 EHD / B 160 EHD	B 185 APC	
F 2000 27.373 DFAS	01/1994 - 12/1995	B 180 APC	B 180 EHD / B 160 EHD	B 185 APC	
F 2000 27.373 DFC	01/1994 - 12/1995	B 180 APC	B 180 EHD / B 160 EHD	B 185 APC	
F 2000 27.373 DFK	01/1994 - 12/1995	B 180 APC	B 180 EHD / B 160 EHD	B 185 APC	
F 2000 27.373 DFS	01/1994 - 12/1995	B 180 APC	B 180 EHD / B 160 EHD	B 185 APC	
F 2000 27.373 DF-TM	07/2000 -	B 180 APC	B 180 EHD / B 160 EHD	B 185 APC	
F 2000 27.403 DFAC	01/1994 -	B 180 APC	B 180 EHD / B 160 EHD	B 185 APC	
F 2000 27.403 DFAK	01/1994 -	B 180 APC	B 180 EHD / B 160 EHD	B 185 APC	
F 2000 27.403 DFAS	01/1994 -	B 180 APC	B 180 EHD / B 160 EHD	B 185 APC	
F 2000 27.403 DFC	01/1994 -	B 180 APC	B 180 EHD / B 160 EHD	B 185 APC	
F 2000 27.403 DFK	01/1994 -	B 180 APC	B 180 EHD / B 160 EHD	B 185 APC	
F 2000 27.403 DFS	01/1994 -	B 180 APC	B 180 EHD / B 160 EHD	B 185 APC	
F 2000 27.403 DF-TM	07/2000 -	B 180 APC	B 180 EHD / B 160 EHD	B 185 APC	
F 2000 27.414 DFAC	05/2001 -	B 180 APC	B 180 EHD / B 160 EHD	B 185 APC	
F 2000 27.414 DFAK, DFA-KI	05/2001 -	B 180 APC	B 180 EHD / B 160 EHD	B 185 APC	
F 2000 27.414 DFAS	05/2001 -	B 180 APC	B 180 EHD / B 160 EHD	B 185 APC	
F 2000 27.414 DFC	05/2001 -	B 180 APC	B 180 EHD / B 160 EHD	B 185 APC	
F 2000 27.414 DFK, DF-KI	05/2001 -	B 180 APC	B 180 EHD / B 160 EHD	B 185 APC	
F 2000 27.414 DFS	05/2001 -	B 180 APC	B 180 EHD / B 160 EHD	B 185 APC	
F 2000 27.414 DF-TM	05/2001 -	B 180 APC	B 180 EHD / B 160 EHD	B 185 APC	
F 2000 27.414 FVL	06/1998 -	B 180 APC	B 180 EHD / B 160 EHD	B 185 APC	
F 2000 27.423 DFAC	01/1994 - 12/1995	B 180 APC	B 180 EHD / B 160 EHD	B 185 APC	
F 2000 27.423 DFAK	01/1994 - 12/1995	B 180 APC	B 180 EHD / B 160 EHD	B 185 APC	
F 2000 27.423 DFAS	01/1994 - 12/1995	B 180 APC	B 180 EHD / B 160 EHD	B 185 APC	
F 2000 27.423 DFC	01/1994 - 12/1995	B 180 APC	B 180 EHD / B 160 EHD	B 185 APC	
F 2000 27.423 DFK	01/1994 - 12/1995	B 180 APC	B 180 EHD / B 160 EHD	B 185 APC	

MARCHIO E MODELLO - MAKE AND MODEL MARQUE ET MODÈLE - MARKE UND MODELL MARCA Y MODELO - МАРКА И МОДЕЛЬ	Periodo Period	powerCUBE		energyCUBE	
		APC	EHD	APC	RST
MAN					
<i>cont.</i>					
F 2000 27.423 DFS	01/1994 - 12/1995	B 180 APC	B 180 EHD / B 160 EHD	B 185 APC	
F 2000 27.423 DF-TM	07/2000 -	B 180 APC	B 180 EHD / B 160 EHD	B 185 APC	
F 2000 27.463 DFAC	01/1994 -	B 180 APC	B 180 EHD / B 160 EHD	B 185 APC	
F 2000 27.463 DFAK	01/1994 -	B 180 APC	B 180 EHD / B 160 EHD	B 185 APC	
F 2000 27.463 DFAS	01/1994 -	B 180 APC	B 180 EHD / B 160 EHD	B 185 APC	
F 2000 27.463 DFC	01/1994 -	B 180 APC	B 180 EHD / B 160 EHD	B 185 APC	
F 2000 27.463 DFK	01/1994 -	B 180 APC	B 180 EHD / B 160 EHD	B 185 APC	
F 2000 27.463 DFS	01/1994 -	B 180 APC	B 180 EHD / B 160 EHD	B 185 APC	
F 2000 27.463 DF-TM	07/2000 -	B 180 APC	B 180 EHD / B 160 EHD	B 185 APC	
F 2000 27.464 DFAC	05/2001 -	B 180 APC	B 180 EHD / B 160 EHD	B 185 APC	
F 2000 27.464 DFAK, DFA-KI	05/2001 -	B 180 APC	B 180 EHD / B 160 EHD	B 185 APC	
F 2000 27.464 DFAS	05/2001 -	B 180 APC	B 180 EHD / B 160 EHD	B 185 APC	
F 2000 27.464 DFC	01/1994 -	B 180 APC	B 180 EHD / B 160 EHD	B 185 APC	
F 2000 27.464 DFK, DF-KI	05/2001 -	B 180 APC	B 180 EHD / B 160 EHD	B 185 APC	
F 2000 27.464 DFS	01/1994 -	B 180 APC	B 180 EHD / B 160 EHD	B 185 APC	
F 2000 27.464 DF-TM	05/2001 -	B 180 APC	B 180 EHD / B 160 EHD	B 185 APC	
F 2000 27.464 FVL	06/1998 -	B 180 APC	B 180 EHD / B 160 EHD	B 185 APC	
F 2000 27.603 DFAS	01/1996 -	B 180 APC	B 180 EHD / B 160 EHD	B 185 APC	
F 2000 27.603 DFS	01/1996 -	B 180 APC	B 180 EHD / B 160 EHD	B 185 APC	
F 2000 32.293 VFC	08/1995 -	B 180 APC	B 180 EHD / B 160 EHD	B 185 APC	
F 2000 32.314 VF, VFC	05/2001 -	B 180 APC	B 180 EHD / B 160 EHD	B 185 APC	
F 2000 32.314 VFK, VF-HK	05/2001 -	B 180 APC	B 180 EHD / B 160 EHD	B 185 APC	
F 2000 32.314 VF-TM	05/2001 -	B 180 APC	B 180 EHD / B 160 EHD	B 185 APC	
F 2000 32.343 VFC	08/1995 -	B 180 APC	B 180 EHD / B 160 EHD	B 185 APC	
F 2000 32.343 VFK	08/1995 -	B 180 APC	B 180 EHD / B 160 EHD	B 185 APC	
F 2000 32.364 VF, VFC	05/2001 -	B 180 APC	B 180 EHD / B 160 EHD	B 185 APC	
F 2000 32.364 VFK, VF-HK	05/2001 -	B 180 APC	B 180 EHD / B 160 EHD	B 185 APC	
F 2000 32.364 VF-TM	05/2001 -	B 180 APC	B 180 EHD / B 160 EHD	B 185 APC	
F 2000 32.403 VFC	08/1995 -	B 180 APC	B 180 EHD / B 160 EHD	B 185 APC	
F 2000 32.403 VFK	08/1995 -	B 180 APC	B 180 EHD / B 160 EHD	B 185 APC	
F 2000 32.414 VF, VFC	05/2001 -	B 180 APC	B 180 EHD / B 160 EHD	B 185 APC	
F 2000 32.414 VFK, VF-HK	05/2001 -	B 180 APC	B 180 EHD / B 160 EHD	B 185 APC	
F 2000 32.414 VF-TM	05/2001 -	B 180 APC	B 180 EHD / B 160 EHD	B 185 APC	
F 2000 32.463 VFC	08/1995 -	B 180 APC	B 180 EHD / B 160 EHD	B 185 APC	
F 2000 32.463 VFK	08/1995 -	B 180 APC	B 180 EHD / B 160 EHD	B 185 APC	
F 2000 32.464 VF, VFC	05/2001 -	B 180 APC	B 180 EHD / B 160 EHD	B 185 APC	
F 2000 32.464 VFK, VF-HK	05/2001 -	B 180 APC	B 180 EHD / B 160 EHD	B 185 APC	
F 2000 32.464 VF-TM	05/2001 -	B 180 APC	B 180 EHD / B 160 EHD	B 185 APC	
F 2000 33.323 DFAC	01/1994 - 12/1995	B 180 APC	B 180 EHD / B 160 EHD	B 185 APC	
F 2000 33.323 DFAK	01/1994 - 12/1995	B 180 APC	B 180 EHD / B 160 EHD	B 185 APC	
F 2000 33.323 DFAS	01/1994 - 12/1995	B 180 APC	B 180 EHD / B 160 EHD	B 185 APC	
F 2000 33.323 DFC	01/1994 - 12/1995	B 180 APC	B 180 EHD / B 160 EHD	B 185 APC	
F 2000 33.323 DFK	01/1994 - 12/1995	B 180 APC	B 180 EHD / B 160 EHD	B 185 APC	
F 2000 33.323 DFS	01/1994 - 12/1995	B 180 APC	B 180 EHD / B 160 EHD	B 185 APC	
F 2000 33.343 DFAC	01/1994 -	B 180 APC	B 180 EHD / B 160 EHD	B 185 APC	

MARCHIO E MODELLO - MAKE AND MODEL MARQUE ET MODÈLE - MARKE UND MODELL MARCA Y MODELO - МАРКА И МОДЕЛЬ	Periodo Period	powerCUBE		energyCUBE	
		APC	EHD	APC	RST
MAN					
<i>cont.</i>					
F 2000 33.343 DFAK	01/1994 -	B 180 APC	B 180 EHD / B 160 EHD	B 185 APC	
F 2000 33.343 DFAS	01/1994 -	B 180 APC	B 180 EHD / B 160 EHD	B 185 APC	
F 2000 33.343 DFC	01/1994 -	B 180 APC	B 180 EHD / B 160 EHD	B 185 APC	
F 2000 33.343 DFK	01/1994 -	B 180 APC	B 180 EHD / B 160 EHD	B 185 APC	
F 2000 33.343 DFS	01/1994 -	B 180 APC	B 180 EHD / B 160 EHD	B 185 APC	
F 2000 33.364 DFAC	05/2001 -	B 180 APC	B 180 EHD / B 160 EHD	B 185 APC	
F 2000 33.364 DFAK, DFA-KI	05/2001 -	B 180 APC	B 180 EHD / B 160 EHD	B 185 APC	
F 2000 33.364 DFAS	05/2001 -	B 180 APC	B 180 EHD / B 160 EHD	B 185 APC	
F 2000 33.364 DFC	05/2001 -	B 180 APC	B 180 EHD / B 160 EHD	B 185 APC	
F 2000 33.364 DFK, DF-KI	05/2001 -	B 180 APC	B 180 EHD / B 160 EHD	B 185 APC	
F 2000 33.364 DFS, DFRS	05/2001 -	B 180 APC	B 180 EHD / B 160 EHD	B 185 APC	
F 2000 33.373 DFAC	01/1994 - 12/1995	B 180 APC	B 180 EHD / B 160 EHD	B 185 APC	
F 2000 33.373 DFAK	01/1994 - 12/1995	B 180 APC	B 180 EHD / B 160 EHD	B 185 APC	
F 2000 33.373 DFAS	01/1994 - 12/1995	B 180 APC	B 180 EHD / B 160 EHD	B 185 APC	
F 2000 33.373 DFC	01/1994 - 12/1995	B 180 APC	B 180 EHD / B 160 EHD	B 185 APC	
F 2000 33.373 DFK	01/1994 - 12/1995	B 180 APC	B 180 EHD / B 160 EHD	B 185 APC	
F 2000 33.373 DFS	01/1994 - 12/1995	B 180 APC	B 180 EHD / B 160 EHD	B 185 APC	
F 2000 33.403 DFAC	01/1994 -	B 180 APC	B 180 EHD / B 160 EHD	B 185 APC	
F 2000 33.403 DFAK	01/1994 -	B 180 APC	B 180 EHD / B 160 EHD	B 185 APC	
F 2000 33.403 DFAS	01/1994 -	B 180 APC	B 180 EHD / B 160 EHD	B 185 APC	
F 2000 33.403 DFC	01/1994 -	B 180 APC	B 180 EHD / B 160 EHD	B 185 APC	
F 2000 33.403 DFK	01/1994 -	B 180 APC	B 180 EHD / B 160 EHD	B 185 APC	
F 2000 33.403 DFS	01/1994 -	B 180 APC	B 180 EHD / B 160 EHD	B 185 APC	
F 2000 33.414 DFAC	05/2001 -	B 180 APC	B 180 EHD / B 160 EHD	B 185 APC	
F 2000 33.414 DFAK, DFA-KI	05/2001 -	B 180 APC	B 180 EHD / B 160 EHD	B 185 APC	
F 2000 33.414 DFAS	05/2001 -	B 180 APC	B 180 EHD / B 160 EHD	B 185 APC	
F 2000 33.414 DFC	05/2001 -	B 180 APC	B 180 EHD / B 160 EHD	B 185 APC	
F 2000 33.414 DFK, DF-KI	05/2001 -	B 180 APC	B 180 EHD / B 160 EHD	B 185 APC	
F 2000 33.414 DFS, DFRS	05/2001 -	B 180 APC	B 180 EHD / B 160 EHD	B 185 APC	
F 2000 33.423 DFAC	01/1994 - 12/1995	B 180 APC	B 180 EHD / B 160 EHD	B 185 APC	
F 2000 33.423 DFAK	01/1994 - 12/1995	B 180 APC	B 180 EHD / B 160 EHD	B 185 APC	
F 2000 33.423 DFAS	01/1994 - 12/1995	B 180 APC	B 180 EHD / B 160 EHD	B 185 APC	
F 2000 33.423 DFC	01/1994 - 12/1995	B 180 APC	B 180 EHD / B 160 EHD	B 185 APC	
F 2000 33.423 DFK	01/1994 - 12/1995	B 180 APC	B 180 EHD / B 160 EHD	B 185 APC	
F 2000 33.423 DFS	01/1994 - 12/1995	B 180 APC	B 180 EHD / B 160 EHD	B 185 APC	
F 2000 33.463 DFAC	01/1994 -	B 180 APC	B 180 EHD / B 160 EHD	B 185 APC	
F 2000 33.463 DFAK	01/1994 -	B 180 APC	B 180 EHD / B 160 EHD	B 185 APC	
F 2000 33.463 DFAS	01/1994 -	B 180 APC	B 180 EHD / B 160 EHD	B 185 APC	
F 2000 33.463 DFC	01/1994 -	B 180 APC	B 180 EHD / B 160 EHD	B 185 APC	
F 2000 33.463 DFK	01/1994 -	B 180 APC	B 180 EHD / B 160 EHD	B 185 APC	
F 2000 33.463 DFS	01/1994 -	B 180 APC	B 180 EHD / B 160 EHD	B 185 APC	
F 2000 33.464 DFAC	05/2001 -	B 180 APC	B 180 EHD / B 160 EHD	B 185 APC	
F 2000 33.464 DFAK, DFA-KI	05/2001 -	B 180 APC	B 180 EHD / B 160 EHD	B 185 APC	
F 2000 33.464 DFAS	05/2001 -	B 180 APC	B 180 EHD / B 160 EHD	B 185 APC	
F 2000 33.464 DFC	05/2001 -	B 180 APC	B 180 EHD / B 160 EHD	B 185 APC	

MARCHIO E MODELLO - MAKE AND MODEL MARQUE ET MODÈLE - MARKE UND MODELL MARCA Y MODELO - МАРКА И МОДЕЛЬ	Periodo Period	powerCUBE		energyCUBE	
		APC	EHD	APC	RST
MAN					
cont.					
F 2000 33.464 DFK, DF-KI	05/2001 -	B 180 APC	B 180 EHD / B 160 EHD	B 185 APC	
F 2000 33.464 DFS, DFRS	05/2001 -	B 180 APC	B 180 EHD / B 160 EHD	B 185 APC	
F 2000 33.603 DFAC	06/1996 -	B 180 APC	B 180 EHD / B 160 EHD	B 185 APC	
F 2000 33.603 DFAS	06/1996 -	B 180 APC	B 180 EHD / B 160 EHD	B 185 APC	
F 2000 33.603 DFC	06/1996 -	B 180 APC	B 180 EHD / B 160 EHD	B 185 APC	
F 2000 33.603 DFS	06/1996 -	B 180 APC	B 180 EHD / B 160 EHD	B 185 APC	
F 2000 35.314 VF-TM	03/2002 -	B 180 APC	B 180 EHD / B 160 EHD	B 185 APC	
F 2000 35.343 VFC	08/1995 -	B 180 APC	B 180 EHD / B 160 EHD	B 185 APC	
F 2000 35.343 VFK	08/1995 -	B 180 APC	B 180 EHD / B 160 EHD	B 185 APC	
F 2000 35.364 VF, VFC, VFRC	05/2001 -	B 180 APC	B 180 EHD / B 160 EHD	B 185 APC	
F 2000 35.364 VFK, VF-HK, VF-KI	03/2002 -	B 180 APC	B 180 EHD / B 160 EHD	B 185 APC	
F 2000 35.364 VF-TM	03/2002 -	B 180 APC	B 180 EHD / B 160 EHD	B 185 APC	
F 2000 35.373 VF, VFC, VFRC	05/2001 -	B 180 APC	B 180 EHD / B 160 EHD	B 185 APC	
F 2000 35.373 VFK, VF-HK, VF-KI	03/2002 -	B 180 APC	B 180 EHD / B 160 EHD	B 185 APC	
F 2000 35.403 VFC	08/1995 -	B 180 APC	B 180 EHD / B 160 EHD	B 185 APC	
F 2000 35.403 VFK	08/1995 -	B 180 APC	B 180 EHD / B 160 EHD	B 185 APC	
F 2000 35.414 VF, VFC, VFRC	05/2001 -	B 180 APC	B 180 EHD / B 160 EHD	B 185 APC	
F 2000 35.414 VFK, VF-HK, VF-KI	03/2002 -	B 180 APC	B 180 EHD / B 160 EHD	B 185 APC	
F 2000 35.414 VF-TM	03/2002 -	B 180 APC	B 180 EHD / B 160 EHD	B 185 APC	
F 2000 35.423 VF, VFC	05/2001 -	B 180 APC	B 180 EHD / B 160 EHD	B 185 APC	
F 2000 35.423 VFK, VF-HK, VF-KI	03/2002 -	B 180 APC	B 180 EHD / B 160 EHD	B 185 APC	
F 2000 35.463 VFC	08/1995 -	B 180 APC	B 180 EHD / B 160 EHD	B 185 APC	
F 2000 35.463 VFK	08/1995 -	B 180 APC	B 180 EHD / B 160 EHD	B 185 APC	
F 2000 35.464 VF, VFC, VFRC	05/2001 -	B 180 APC	B 180 EHD / B 160 EHD	B 185 APC	
F 2000 35.464 VFK, VF-HK, VF-KI	03/2002 -	B 180 APC	B 180 EHD / B 160 EHD	B 185 APC	
F 2000 35.464 VF-TM	03/2002 -	B 180 APC	B 180 EHD / B 160 EHD	B 185 APC	
F 2000 37.414 VFA	06/1998 -	B 180 APC	B 180 EHD / B 160 EHD	B 185 APC	
F 2000 37.464 VFA	06/1998 -	B 180 APC	B 180 EHD / B 160 EHD	B 185 APC	
F 2000 40.273 DFAK	01/1994 -	B 180 APC	B 180 EHD / B 160 EHD	B 185 APC	
F 2000 40.273 DFK	01/1994 - 12/1995	B 180 APC	B 180 EHD / B 160 EHD	B 185 APC	
F 2000 40.373 DFAK	05/2001 -	B 180 APC	B 180 EHD / B 160 EHD	B 185 APC	
F 2000 40.373 DFK	05/2001 -	B 180 APC	B 180 EHD / B 160 EHD	B 185 APC	
F 2000 40.403 DFAK	01/1994 -	B 180 APC	B 180 EHD / B 160 EHD	B 185 APC	
F 2000 40.403 DFAS	01/1994 -	B 180 APC	B 180 EHD / B 160 EHD	B 185 APC	
F 2000 40.403 DFK	01/1994 -	B 180 APC	B 180 EHD / B 160 EHD	B 185 APC	
F 2000 40.403 DFS	01/1994 -	B 180 APC	B 180 EHD / B 160 EHD	B 185 APC	
F 2000 40.414 DFAK	05/2001 -	B 180 APC	B 180 EHD / B 160 EHD	B 185 APC	
F 2000 40.414 DFK	05/2001 -	B 180 APC	B 180 EHD / B 160 EHD	B 185 APC	
F 2000 40.423 DFAK	05/2001 -	B 180 APC	B 180 EHD / B 160 EHD	B 185 APC	
F 2000 40.423 DFK	05/2001 -	B 180 APC	B 180 EHD / B 160 EHD	B 185 APC	
F 2000 40.463 DFAK	01/1994 -	B 180 APC	B 180 EHD / B 160 EHD	B 185 APC	
F 2000 40.463 DFAS	01/1994 -	B 180 APC	B 180 EHD / B 160 EHD	B 185 APC	
F 2000 40.463 DFK	01/1994 -	B 180 APC	B 180 EHD / B 160 EHD	B 185 APC	
F 2000 40.463 DFS	01/1994 -	B 180 APC	B 180 EHD / B 160 EHD	B 185 APC	
F 2000 41.343 VFC	08/1995 -	B 180 APC	B 180 EHD / B 160 EHD	B 185 APC	

MARCHIO E MODELLO - MAKE AND MODEL MARQUE ET MODÈLE - MARKE UND MODELL MARCA Y MODELO - МАРКА И МОДЕЛЬ	Periodo Period	powerCUBE		energyCUBE	
		APC	EHD	APC	RST
MAN					
cont.					
F 2000 41.343 VFK	08/1995 -	B 180 APC	B 180 EHD / B 160 EHD	B 185 APC	
F 2000 41.364 VF, VFC, VFRC	05/2001 -	B 180 APC	B 180 EHD / B 160 EHD	B 185 APC	
F 2000 41.364 VFK, VF-HK, VF-KI	03/2002 -	B 180 APC	B 180 EHD / B 160 EHD	B 185 APC	
F 2000 41.373 VF, VFC, VFRC	05/2001 -	B 180 APC	B 180 EHD / B 160 EHD	B 185 APC	
F 2000 41.373 VFK, VF-HK, VF-KI	03/2002 -	B 180 APC	B 180 EHD / B 160 EHD	B 185 APC	
F 2000 41.403 VFC	08/1995 -	B 180 APC	B 180 EHD / B 160 EHD	B 185 APC	
F 2000 41.403 VFK	08/1995 -	B 180 APC	B 180 EHD / B 160 EHD	B 185 APC	
F 2000 41.414 VF, VFC, VFRC	05/2001 -	B 180 APC	B 180 EHD / B 160 EHD	B 185 APC	
F 2000 41.414 VFK, VF-HK, VF-KI	03/2002 -	B 180 APC	B 180 EHD / B 160 EHD	B 185 APC	
F 2000 41.423 VF, VFC, VFRC	05/2001 -	B 180 APC	B 180 EHD / B 160 EHD	B 185 APC	
F 2000 41.423 VFK, VF-HK, VF-KI	03/2002 -	B 180 APC	B 180 EHD / B 160 EHD	B 185 APC	
F 2000 41.463 VFC	08/1995 -	B 180 APC	B 180 EHD / B 160 EHD	B 185 APC	
F 2000 41.463 VFK	08/1995 -	B 180 APC	B 180 EHD / B 160 EHD	B 185 APC	
F 2000 41.464 VF, VFC, VFRC	08/1995 -	B 180 APC	B 180 EHD / B 160 EHD	B 185 APC	
F 2000 41.464 VFK, VF-HK, VF-KI	03/2002 -	B 180 APC	B 180 EHD / B 160 EHD	B 185 APC	
F 9 15.192 F, 15.192 FL	01/1983 - 12/1986	A 135 APC	A 140 EHD		
F 9 15.192 FS	01/1983 - 12/1986	A 135 APC	A 140 EHD		
F 90 15.192 FL		B 180 APC		B 185 APC	
F 90 19.242 F,19.242 FL,19.242 FLL	01/1988 - 01/1989	A 135 APC	A 140 EHD		
F 90 19.242 FK	01/1988 - 02/1989	A 135 APC	A 140 EHD		
F 90 19.242 FS,19.242 FLS,19.242 FLLS	01/1988 - 01/1989	A 135 APC	A 140 EHD		
F 90 19.262 F,19.262 FL,19.262 FLL	01/1988 - 02/1990	A 135 APC	A 140 EHD		
F 90 19.262 FA	02/1989 - 02/1990	A 135 APC	A 140 EHD		
F 90 19.262 FAK	02/1989 - 02/1990	A 135 APC	A 140 EHD		
F 90 19.262 FAS	02/1989 - 02/1990	A 135 APC	A 140 EHD		
F 90 19.262 FK	01/1988 - 02/1990	A 135 APC	A 140 EHD		
F 90 19.262 FS,19.262 FLS,19.262 FLLS	01/1988 - 02/1990	A 135 APC	A 140 EHD		
F 90 19.272 F,19.272 FL,19.272 FLL	02/1990 - 05/1995	A 135 APC	A 140 EHD		
F 90 19.272 FA	02/1990 - 05/1995	A 135 APC	A 140 EHD		
F 90 19.272 FAK	02/1990 - 05/1995	A 135 APC	A 140 EHD		
F 90 19.272 FAS	02/1990 - 05/1995	A 135 APC	A 140 EHD		
F 90 19.272 FK	02/1990 - 05/1995	A 135 APC	A 140 EHD		
F 90 19.272 FS,19.272 FLS,19.272 FLLS	02/1990 - 05/1995	A 135 APC	A 140 EHD		
F 90 19.292 F,19.292 FL,19.292 FLL	07/1986 - 02/1990	A 135 APC	A 140 EHD		
F 90 19.292 FA	05/1988 - 02/1990	A 135 APC	A 140 EHD		
F 90 19.292 FAK	05/1988 - 02/1990	A 135 APC	A 140 EHD		
F 90 19.292 FAS	05/1988 - 02/1990	A 135 APC	A 140 EHD		
F 90 19.292 FK	07/1986 - 02/1990	A 135 APC	A 140 EHD		
F 90 19.292 FS,19.292 FLS,19.292 FLLS	07/1986 - 02/1990	A 135 APC	A 140 EHD		
F 90 19.322 F,19.322 FL,19.322 FLL	02/1990 - 05/1995	A 135 APC	A 140 EHD		
F 90 19.322 FA	02/1990 - 06/1996	A 135 APC	A 140 EHD		
F 90 19.322 FAK	02/1990 - 06/1996	A 135 APC	A 140 EHD		
F 90 19.322 FAS	02/1990 - 06/1996	A 135 APC	A 140 EHD		
F 90 19.322 FK	02/1990 - 05/1995	A 135 APC	A 140 EHD		
F 90 19.322 FS,19.322 FLS,19.322 FLLS	02/1990 - 05/1995	A 135 APC	A 140 EHD		

MARCHIO E MODELLO - MAKE AND MODEL MARQUE ET MODÈLE - MARKE UND MODELL MARCA Y MODELO - МАРКА И МОДЕЛЬ	Periodo Period	powerCUBE		energyCUBE	
		APC	EHD	APC	RST
MAN cont.					
F 90 19.332 F,19.332 FL,19.332 FLL	07/1986 - 02/1990	A 135 APC	A 140 EHD		
F 90 19.332 FA	05/1988 - 02/1990	A 135 APC	A 140 EHD		
F 90 19.332 FAK	05/1988 - 02/1990	A 135 APC	A 140 EHD		
F 90 19.332 FAS	05/1988 - 02/1990	A 135 APC	A 140 EHD		
F 90 19.332 FK	07/1986 - 02/1990	A 135 APC	A 140 EHD		
F 90 19.332 FS,19.332 FLS,19.332 FLLS	07/1986 - 02/1990	A 135 APC	A 140 EHD		
F 90 19.342 F,19.342 FL,19.342 FLL	05/1994 - 05/1995	A 135 APC	A 140 EHD		
F 90 19.342 FA	05/1994 - 06/1996	A 135 APC	A 140 EHD		
F 90 19.342 FAK	05/1994 - 06/1996	A 135 APC	A 140 EHD		
F 90 19.342 FAS	05/1994 - 06/1996	A 135 APC	A 140 EHD		
F 90 19.342 FK	05/1994 - 05/1995	A 135 APC	A 140 EHD		
F 90 19.342 FS,19.342 FLS,19.342 FLLS	05/1994 - 05/1995	A 135 APC	A 140 EHD		
F 90 19.362 F,19.362 FL,19.362 FLL	07/1986 - 02/1990	A 135 APC	A 140 EHD		
F 90 19.362 FA	05/1988 - 02/1990	A 135 APC	A 140 EHD		
F 90 19.362 FAK	05/1988 - 02/1990	A 135 APC	A 140 EHD		
F 90 19.362 FAS	05/1988 - 02/1990	A 135 APC	A 140 EHD		
F 90 19.362 FK	07/1986 - 02/1990	A 135 APC	A 140 EHD		
F 90 19.362 FS,19.362 FLS,19.362 FLLS	07/1986 - 02/1990	A 135 APC	A 140 EHD		
F 90 19.372 F,19.372 FL,19.372 FLL	02/1990 - 05/1995	A 135 APC	A 140 EHD		
F 90 19.372 F,19.372 FL,19.372 FLL	05/1990 - 04/1995	A 135 APC	A 140 EHD		
F 90 19.372 FA	02/1990 - 06/1996	A 135 APC	A 140 EHD		
F 90 19.372 FAK	02/1990 - 06/1996	A 135 APC	A 140 EHD		
F 90 19.372 FAS	02/1990 - 06/1996	A 135 APC	A 140 EHD		
F 90 19.372 FK	02/1990 - 05/1995	A 135 APC	A 140 EHD		
F 90 19.372 FK	05/1990 - 04/1995	A 135 APC	A 140 EHD		
F 90 19.372 FS,19.372 FLS,19.372 FLLS	02/1990 - 05/1995	A 135 APC	A 140 EHD		
F 90 19.372 FS,19.372 FLS,19.372 FLLS	05/1990 - 04/1995	A 135 APC	A 140 EHD		
F 90 19.402 F,19.402 FL,19.402 FLL	05/1994 - 05/1995	A 135 APC	A 140 EHD		
F 90 19.402 FA	05/1994 - 06/1996	A 135 APC	A 140 EHD		
F 90 19.402 FAK	05/1994 - 06/1996	A 135 APC	A 140 EHD		
F 90 19.402 FAS	05/1994 - 06/1996	A 135 APC	A 140 EHD		
F 90 19.402 FK	05/1994 - 05/1995	A 135 APC	A 140 EHD		
F 90 19.402 FS,19.402 FLS,19.402 FLLS	05/1994 - 05/1995	A 135 APC	A 140 EHD		
F 90 19.422 F,19.422 FL,19.422 FLL	02/1990 - 05/1995	A 135 APC	A 140 EHD		
F 90 19.422 FA	02/1990 - 06/1996	A 135 APC	A 140 EHD		
F 90 19.422 FAK	02/1990 - 06/1996	A 135 APC	A 140 EHD		
F 90 19.422 FAS	02/1990 - 06/1996	A 135 APC	A 140 EHD		
F 90 19.422 FK	02/1990 - 05/1995	A 135 APC	A 140 EHD		
F 90 19.422 FS,19.422 FLS,19.422 FLLS	02/1990 - 05/1995	A 135 APC	A 140 EHD		
F 90 19.462 F,19.462 FL	05/1987 - 02/1990	A 135 APC	A 140 EHD		
F 90 19.462 FK	05/1987 - 02/1990	A 135 APC	A 140 EHD		
F 90 19.462 FS,19.462 FLS	05/1987 - 02/1990	A 135 APC	A 140 EHD		
F 90 19.502 F,19.502 FL,19.502 FLL	02/1990 - 06/1996	A 135 APC	A 140 EHD		
F 90 19.502 FS,19.502 FLS,19.502 FLLS	02/1990 - 06/1996	A 135 APC	A 140 EHD		
F 90 24.242 DF	01/1988 - 07/1989	B 180 APC	B 180 EHD	B 185 APC	

MARCHIO E MODELLO - MAKE AND MODEL MARQUE ET MODÈLE - MARKE UND MODELL MARCA Y MODELO - МАРКА И МОДЕЛЬ	Periodo Period	powerCUBE		energyCUBE	
		APC	EHD	APC	RST
MAN					
cont.					
F 90 24.242 DFK	01/1988 - 07/1989	B 180 APC	B 180 EHD	B 185 APC	
F 90 24.242 DFS	01/1988 - 07/1989	B 180 APC	B 180 EHD	B 185 APC	
F 90 24.242 FNL,24.242 FNLL,24.242 FVL	01/1988 - 02/1990	B 180 APC	B 180 EHD	B 185 APC	
F 90 24.262 DF	01/1988 - 02/1990	B 180 APC	B 180 EHD	B 185 APC	
F 90 24.262 DFK	01/1988 - 02/1990	B 180 APC	B 180 EHD	B 185 APC	
F 90 24.262 DFS,24.262 DFSL	01/1988 - 02/1990	B 180 APC	B 180 EHD	B 185 APC	
F 90 24.262 FNL,24.262 FNLL,24.262 FVL	01/1988 - 02/1990	B 180 APC	B 180 EHD	B 185 APC	
F 90 24.272 DF	02/1990 - 12/1990	B 180 APC	B 180 EHD	B 185 APC	
F 90 24.272 DFK	02/1990 - 12/1990	B 180 APC	B 180 EHD	B 185 APC	
F 90 24.272 DFS,24.272 DFSL	02/1990 - 04/1995	B 180 APC	B 180 EHD	B 185 APC	
F 90 24.272 FNL,24.272 FNLL,24.272 FVL	02/1990 - 05/1995	B 180 APC	B 180 EHD	B 185 APC	
F 90 24.272 FNLS,24.272 FVLS	02/1990 - 05/1995	B 180 APC	B 180 EHD	B 185 APC	
F 90 24.292 DF	04/1987 - 02/1990	B 180 APC	B 180 EHD	B 185 APC	
F 90 24.292 DFK	04/1987 - 02/1990	B 180 APC	B 180 EHD	B 185 APC	
F 90 24.292 DFS,24.292 DFSL	04/1987 - 02/1990	B 180 APC	B 180 EHD	B 185 APC	
F 90 24.292 FNL,24.292 FNLL,24.292 FVL	10/1986 - 02/1990	B 180 APC	B 180 EHD	B 185 APC	
F 90 24.292 FNLS,24.292 FVLS	10/1986 - 02/1990	B 180 APC	B 180 EHD	B 185 APC	
F 90 24.302 DF	05/1990 - 12/1990	B 180 APC	B 180 EHD	B 185 APC	
F 90 24.302 DFK	05/1990 - 12/1990	B 180 APC	B 180 EHD	B 185 APC	
F 90 24.302 DFS,24.302 DFSL	05/1990 - 04/1995	B 180 APC	B 180 EHD	B 185 APC	
F 90 24.302 FNL,24.302 FNLL,24.302 FVL	05/1990 - 10/1990	B 180 APC	B 180 EHD	B 185 APC	
F 90 24.322 DF	02/1990 - 12/1990	B 180 APC	B 180 EHD	B 185 APC	
F 90 24.322 DFK	02/1990 - 12/1990	B 180 APC	B 180 EHD	B 185 APC	
F 90 24.322 DFS,24.322 DFSL	02/1990 - 12/1990	B 180 APC	B 180 EHD	B 185 APC	
F 90 24.322 FNL,24.322 FNLL,24.322 FVL	02/1990 - 05/1995	B 180 APC	B 180 EHD	B 185 APC	
F 90 24.322 FNLS,24.322 FVLS	02/1990 - 05/1995	B 180 APC	B 180 EHD	B 185 APC	
F 90 24.332 DF	04/1987 - 02/1990	B 180 APC	B 180 EHD	B 185 APC	
F 90 24.332 DFK	04/1987 - 02/1990	B 180 APC	B 180 EHD	B 185 APC	
F 90 24.332 DFS,24.332 DFSL	04/1987 - 02/1990	B 180 APC	B 180 EHD	B 185 APC	
F 90 24.332 FNL,24.332 FNLL,24.332 FVL	10/1986 - 02/1990	B 180 APC	B 180 EHD	B 185 APC	
F 90 24.332 FNLS,24.332 FVLS	10/1986 - 02/1990	B 180 APC	B 180 EHD	B 185 APC	
F 90 24.342 FNL,24.342 FNLL	05/1994 - 05/1995	B 180 APC	B 180 EHD	B 185 APC	
F 90 24.362 DF	04/1987 - 02/1990	B 180 APC	B 180 EHD	B 185 APC	
F 90 24.362 DFK	04/1987 - 02/1990	B 180 APC	B 180 EHD	B 185 APC	
F 90 24.362 DFS,24.362 DFSL	04/1987 - 02/1990	B 180 APC	B 180 EHD	B 185 APC	
F 90 24.362 FNL,24.362 FNLL,24.362 FVL	10/1986 - 02/1990	B 180 APC	B 180 EHD	B 185 APC	
F 90 24.362 FNLS,24.362 FVLS	10/1986 - 02/1990	B 180 APC	B 180 EHD	B 185 APC	
F 90 24.372 DF	02/1990 - 12/1990	B 180 APC	B 180 EHD	B 185 APC	
F 90 24.372 DF	05/1990 - 12/1990	B 180 APC	B 180 EHD	B 185 APC	
F 90 24.372 DFK	02/1990 - 12/1990	B 180 APC	B 180 EHD	B 185 APC	
F 90 24.372 DFK	05/1990 - 12/1990	B 180 APC	B 180 EHD	B 185 APC	
F 90 24.372 DFS	05/1990 - 12/1990	B 180 APC	B 180 EHD	B 185 APC	
F 90 24.372 DFS,24.372 DFSL	02/1990 - 04/1995	B 180 APC	B 180 EHD	B 185 APC	
F 90 24.372 FNL,24.372 FNLL,24.372 FVL	02/1990 - 05/1995	B 180 APC	B 180 EHD	B 185 APC	
F 90 24.372 FNLS,24.372 FVLS	02/1990 - 05/1995	B 180 APC	B 180 EHD	B 185 APC	

MARCHIO E MODELLO - MAKE AND MODEL MARQUE ET MODÈLE - MARKE UND MODELL MARCA Y MODELO - МАРКА И МОДЕЛЬ	Periodo Period	powerCUBE		energyCUBE	
		APC	EHD	APC	RST
MAN					
cont.					
F 90 24.372 FVL	05/1990 - 12/1990	B 180 APC	B 180 EHD	B 185 APC	
F 90 24.372 FVLS	05/1990 - 12/1990	B 180 APC	B 180 EHD	B 185 APC	
F 90 24.402 FNL,24.402 FNLL	05/1994 - 05/1995	B 180 APC	B 180 EHD	B 185 APC	
F 90 24.422 DF	02/1990 - 12/1990	B 180 APC	B 180 EHD	B 185 APC	
F 90 24.422 DFK	02/1990 - 12/1990	B 180 APC	B 180 EHD	B 185 APC	
F 90 24.422 DFS,24.422 DFLS	02/1990 - 12/1990	B 180 APC	B 180 EHD	B 185 APC	
F 90 24.422 FNL,24.422 FNLL,24.422 FVL	02/1990 - 05/1995	B 180 APC	B 180 EHD	B 185 APC	
F 90 24.462 DF	02/1989 - 02/1990	B 180 APC	B 180 EHD	B 185 APC	
F 90 24.462 DFS	02/1989 - 02/1990	B 180 APC	B 180 EHD	B 185 APC	
F 90 24.462 FNL	04/1989 - 02/1990	B 180 APC	B 180 EHD	B 185 APC	
F 90 24.462 FVLS	05/1987 - 07/1987	B 180 APC	B 180 EHD	B 185 APC	
F 90 24.502 DF	02/1990 - 12/1990	B 180 APC	B 180 EHD	B 185 APC	
F 90 24.502 DFK	02/1990 - 12/1990	B 180 APC	B 180 EHD	B 185 APC	
F 90 24.502 DFS	02/1990 - 12/1990	B 180 APC	B 180 EHD	B 185 APC	
F 90 24.502 FNL	02/1990 - 12/1990	B 180 APC	B 180 EHD	B 185 APC	
F 90 25.272 DF	09/1990 - 12/1992	B 180 APC	B 180 EHD	B 185 APC	
F 90 25.272 DFK	09/1990 - 12/1992	B 180 APC	B 180 EHD	B 185 APC	
F 90 25.272 DFS,25.272 DFLS	09/1990 - 12/1992	B 180 APC	B 180 EHD	B 185 APC	
F 90 25.272 FNL,25.272 FNLL,25.272 FVL	09/1990 - 10/1993	B 180 APC	B 180 EHD	B 185 APC	
F 90 25.302 DF	09/1990 - 12/1991	B 180 APC	B 180 EHD	B 185 APC	
F 90 25.302 DFK	09/1990 - 12/1991	B 180 APC	B 180 EHD	B 185 APC	
F 90 25.302 DFS,25.302 DFLS	09/1990 - 12/1991	B 180 APC	B 180 EHD	B 185 APC	
F 90 25.302 FNL,25.302 FNLL	09/1990 - 12/1991	B 180 APC	B 180 EHD	B 185 APC	
F 90 25.302 FNLS,25.302 FVLS	09/1990 - 12/1991	B 180 APC	B 180 EHD	B 185 APC	
F 90 25.322 DF	09/1990 - 12/1992	B 180 APC	B 180 EHD	B 185 APC	
F 90 25.322 DFK	09/1990 - 12/1992	B 180 APC	B 180 EHD	B 185 APC	
F 90 25.322 DFS,25.322 DFLS	09/1990 - 12/1992	B 180 APC	B 180 EHD	B 185 APC	
F 90 25.322 FNL,25.322 FNLL	09/1990 - 12/1992	B 180 APC	B 180 EHD	B 185 APC	
F 90 25.322 FNLS,25.322 FVLS	09/1990 - 12/1992	B 180 APC	B 180 EHD	B 185 APC	
F 90 25.372 DF	09/1990 - 12/1992	B 180 APC	B 180 EHD	B 185 APC	
F 90 25.372 DFK	09/1990 - 12/1992	B 180 APC	B 180 EHD	B 185 APC	
F 90 25.372 DFS	09/1990 - 12/1992	B 180 APC	B 180 EHD	B 185 APC	
F 90 25.372 DFS,25.372 DFLS	09/1990 - 12/1992	B 180 APC	B 180 EHD	B 185 APC	
F 90 25.372 FNL,25.372 FNLL	09/1990 - 12/1992	B 180 APC	B 180 EHD	B 185 APC	
F 90 25.372 FNLS,25.372 FVLS	09/1990 - 10/1993	B 180 APC	B 180 EHD	B 185 APC	
F 90 25.372 FVLS	09/1990 - 10/1993	B 180 APC	B 180 EHD	B 185 APC	
F 90 25.422 DF	09/1990 - 12/1992	B 180 APC	B 180 EHD	B 185 APC	
F 90 25.422 DFK	09/1990 - 12/1992	B 180 APC	B 180 EHD	B 185 APC	
F 90 25.422 DFS,25.422 DFLS	09/1990 - 12/1992	B 180 APC	B 180 EHD	B 185 APC	
F 90 25.422 FNL,25.422 FNLL	09/1990 - 12/1992	B 180 APC	B 180 EHD	B 185 APC	
F 90 25.422 FNLS,25.422 FVLS	09/1990 - 12/1992	B 180 APC	B 180 EHD	B 185 APC	
F 90 25.502 DF	09/1990 - 12/1992	B 180 APC	B 180 EHD	B 185 APC	
F 90 25.502 DFS	09/1990 - 12/1992	B 180 APC	B 180 EHD	B 185 APC	
F 90 25.502 FNL	09/1990 - 12/1992	B 180 APC	B 180 EHD	B 185 APC	
F 90 26.242 DF	01/1988 - 07/1989	B 180 APC	B 180 EHD	B 185 APC	

MARCHIO E MODELLO - MAKE AND MODEL MARQUE ET MODÈLE - MARKE UND MODELL MARCA Y MODELO - МАРКА И МОДЕЛЬ	Periodo <i>Period</i>	powerCUBE		energyCUBE	
		APC	EHD	APC	RST
MAN					
	<i>cont.</i>				
F 90 26.242 DFAK	02/1989 - 07/1989	B 180 APC	B 180 EHD	B 185 APC	
F 90 26.242 DFK	01/1988 - 07/1989	B 180 APC	B 180 EHD	B 185 APC	
F 90 26.242 DFS	01/1988 - 07/1989	B 180 APC	B 180 EHD	B 185 APC	
F 90 26.262 DF	01/1988 - 02/1990	B 180 APC	B 180 EHD	B 185 APC	
F 90 26.262 DFA	02/1989 - 02/1990	B 180 APC	B 180 EHD	B 185 APC	
F 90 26.262 DFAK	02/1989 - 02/1990	B 180 APC	B 180 EHD	B 185 APC	
F 90 26.262 DFAS	02/1989 - 02/1990	B 180 APC	B 180 EHD	B 185 APC	
F 90 26.262 DFK	01/1988 - 02/1990	B 180 APC	B 180 EHD	B 185 APC	
F 90 26.262 DFS	01/1988 - 02/1990	B 180 APC	B 180 EHD	B 185 APC	
F 90 26.272 DF	02/1990 - 06/1996	B 180 APC	B 180 EHD	B 185 APC	
F 90 26.272 DFA	02/1990 - 12/1992	B 180 APC	B 180 EHD	B 185 APC	
F 90 26.272 DFAK	02/1990 - 12/1992	B 180 APC	B 180 EHD	B 185 APC	
F 90 26.272 DFAS	02/1990 - 12/1992	B 180 APC	B 180 EHD	B 185 APC	
F 90 26.272 DFK	02/1990 - 06/1996	B 180 APC	B 180 EHD	B 185 APC	
F 90 26.272 DFS,26.272 DFSL	02/1990 - 06/1996	B 180 APC	B 180 EHD	B 185 APC	
F 90 26.272 FNL,26.272 FNLL	03/1991 - 05/1995	B 180 APC	B 180 EHD	B 185 APC	
F 90 26.272 FNLS,26.272 FVLS	09/1990 - 12/1995	B 180 APC	B 180 EHD	B 185 APC	
F 90 26.292 DF	09/1987 - 02/1990	B 180 APC	B 180 EHD	B 185 APC	
F 90 26.292 DFA	05/1988 - 02/1990	B 180 APC	B 180 EHD	B 185 APC	
F 90 26.292 DFAK	05/1988 - 02/1990	B 180 APC	B 180 EHD	B 185 APC	
F 90 26.292 DFAS	05/1988 - 02/1990	B 180 APC	B 180 EHD	B 185 APC	
F 90 26.292 DFK	09/1987 - 02/1990	B 180 APC	B 180 EHD	B 185 APC	
F 90 26.292 DFS	09/1987 - 02/1990	B 180 APC	B 180 EHD	B 185 APC	
F 90 26.302 DF	05/1990 - 12/1991	B 180 APC	B 180 EHD	B 185 APC	
F 90 26.302 DFA	05/1990 - 12/1991	B 180 APC	B 180 EHD	B 185 APC	
F 90 26.302 DFAK	05/1990 - 12/1991	B 180 APC	B 180 EHD	B 185 APC	
F 90 26.302 DFAS	05/1990 - 12/1991	B 180 APC	B 180 EHD	B 185 APC	
F 90 26.302 DFK	05/1990 - 12/1991	B 180 APC	B 180 EHD	B 185 APC	
F 90 26.302 DFS	05/1990 - 12/1991	B 180 APC	B 180 EHD	B 185 APC	
F 90 26.302 FNL,26.302 FNLL	03/1991 - 12/1991	B 180 APC	B 180 EHD	B 185 APC	
F 90 26.302 FNLS,26.302 FVLS	09/1990 - 12/1991	B 180 APC	B 180 EHD	B 185 APC	
F 90 26.322 DF	02/1990 - 06/1996	B 180 APC	B 180 EHD	B 185 APC	
F 90 26.322 DFA	02/1990 - 12/1992	B 180 APC	B 180 EHD	B 185 APC	
F 90 26.322 DFAK	02/1990 - 12/1992	B 180 APC	B 180 EHD	B 185 APC	
F 90 26.322 DFAS	02/1990 - 12/1992	B 180 APC	B 180 EHD	B 185 APC	
F 90 26.322 DFK	02/1992 - 06/1996	B 180 APC	B 180 EHD	B 185 APC	
F 90 26.322 DFS,26.322 DFSL	02/1990 - 06/1996	B 180 APC	B 180 EHD	B 185 APC	
F 90 26.322 FNL,26.322 FNLL	03/1991 - 05/1995	B 180 APC	B 180 EHD	B 185 APC	
F 90 26.322 FNLS,26.322 FVLS	09/1990 - 12/1995	B 180 APC	B 180 EHD	B 185 APC	
F 90 26.332 DF	09/1987 - 02/1990	B 180 APC	B 180 EHD	B 185 APC	
F 90 26.332 DFA	05/1988 - 02/1990	B 180 APC	B 180 EHD	B 185 APC	
F 90 26.332 DFAK	05/1988 - 02/1990	B 180 APC	B 180 EHD	B 185 APC	
F 90 26.332 DFAS	05/1988 - 02/1990	B 180 APC	B 180 EHD	B 185 APC	
F 90 26.332 DFK	09/1987 - 02/1990	B 180 APC	B 180 EHD	B 185 APC	
F 90 26.332 DFS	09/1987 - 02/1990	B 180 APC	B 180 EHD	B 185 APC	

MARCHIO E MODELLO - MAKE AND MODEL MARQUE ET MODÈLE - MARKE UND MODELL MARCA Y MODELO - МАРКА И МОДЕЛЬ	Periodo Period	powerCUBE		energyCUBE	
		APC	EHD	APC	RST
MAN					
<i>cont.</i>					
F 90 26.342 DF,26.342 DFL	05/1994 - 06/1996	B 180 APC	B 180 EHD	B 185 APC	
F 90 26.342 DFK,26.342 DFLK	05/1994 - 06/1996	B 180 APC	B 180 EHD	B 185 APC	
F 90 26.342 DFS	04/1994 - 06/1996	B 180 APC	B 180 EHD	B 185 APC	
F 90 26.362 DF,26.362 DFL	09/1987 - 02/1990	B 180 APC	B 180 EHD	B 185 APC	
F 90 26.362 DFA	05/1988 - 02/1990	B 180 APC	B 180 EHD	B 185 APC	
F 90 26.362 DFAK	05/1988 - 02/1990	B 180 APC	B 180 EHD	B 185 APC	
F 90 26.362 DFAS	05/1988 - 02/1990	B 180 APC	B 180 EHD	B 185 APC	
F 90 26.362 DFK	09/1987 - 02/1990	B 180 APC	B 180 EHD	B 185 APC	
F 90 26.362 DFS	09/1987 - 02/1990	B 180 APC	B 180 EHD	B 185 APC	
F 90 26.372 DF,26.372 DFL	02/1990 - 06/1996	B 180 APC	B 180 EHD	B 185 APC	
F 90 26.372 DFA	02/1990 - 12/1992	B 180 APC	B 180 EHD	B 185 APC	
F 90 26.372 DFAK	01/1992 - 06/1996	B 180 APC	B 180 EHD	B 185 APC	
F 90 26.372 DFAS	02/1990 - 12/1992	B 180 APC	B 180 EHD	B 185 APC	
F 90 26.372 DFK	01/1992 - 06/1996	B 180 APC	B 180 EHD	B 185 APC	
F 90 26.372 DFS	02/1990 - 06/1996	B 180 APC	B 180 EHD	B 185 APC	
F 90 26.372 FNL,26.372 FNLL,26.372 FVL	09/1990 - 12/1995	B 180 APC	B 180 EHD	B 185 APC	
F 90 26.372 FNLS,26.372 FVLS	01/1992 - 06/1996	B 180 APC	B 180 EHD	B 185 APC	
F 90 26.402 DF,26.402 DFL	05/1994 - 06/1996	B 180 APC	B 180 EHD	B 185 APC	
F 90 26.402 DFK,26.402 DFLK	05/1994 - 06/1996	B 180 APC	B 180 EHD	B 185 APC	
F 90 26.402 DFS	05/1994 - 12/1995	B 180 APC	B 180 EHD	B 185 APC	
F 90 26.402 FNL,26.402 FNLL,26.402 FVL	05/1994 - 06/1996	B 180 APC	B 180 EHD	B 185 APC	
F 90 26.402 FNLS,26.402 FVLS	05/1994 - 06/1996	B 180 APC	B 180 EHD	B 185 APC	
F 90 26.422 DF,26.422 DFL	02/1990 - 06/1996	B 180 APC	B 180 EHD	B 185 APC	
F 90 26.422 DFA	02/1990 - 12/1992	B 180 APC	B 180 EHD	B 185 APC	
F 90 26.422 DFAK	02/1990 - 12/1992	B 180 APC	B 180 EHD	B 185 APC	
F 90 26.422 DFAS	02/1990 - 12/1992	B 180 APC	B 180 EHD	B 185 APC	
F 90 26.422 DFK	02/1990 - 12/1995	B 180 APC	B 180 EHD	B 185 APC	
F 90 26.422 DFS	02/1990 - 12/1995	B 180 APC	B 180 EHD	B 185 APC	
F 90 26.422 FNL,26.422 FNLL,26.422 FVL	09/1990 - 12/1995	B 180 APC	B 180 EHD	B 185 APC	
F 90 26.422 FNLS,26.422 FVLS	01/1992 - 12/1995	B 180 APC	B 180 EHD	B 185 APC	
F 90 26.462 DF	02/1989 - 02/1990	B 180 APC	B 180 EHD	B 185 APC	
F 90 26.462 DFA	08/1989 - 02/1990	B 180 APC	B 180 EHD	B 185 APC	
F 90 26.462 DFAS	08/1989 - 02/1990	B 180 APC	B 180 EHD	B 185 APC	
F 90 26.462 DFS	02/1989 - 02/1990	B 180 APC	B 180 EHD	B 185 APC	
F 90 26.502 DF	02/1990 - 06/1996	B 180 APC	B 180 EHD	B 185 APC	
F 90 26.502 DFA	02/1990 - 12/1992	B 180 APC	B 180 EHD	B 185 APC	
F 90 26.502 DFAS	02/1990 - 12/1992	B 180 APC	B 180 EHD	B 185 APC	
F 90 26.502 DFS,26.502 DFSL	02/1990 - 06/1996	B 180 APC	B 180 EHD	B 185 APC	
F 90 26.502 FNL,26.502 FNLL	09/1991 - 06/1996	B 180 APC	B 180 EHD	B 185 APC	
F 90 32.262 VF	02/1989 - 02/1990	B 180 APC	B 180 EHD	B 185 APC	
F 90 32.262 VFK	02/1989 - 02/1990	B 180 APC	B 180 EHD	B 185 APC	
F 90 32.262 VFTM	02/1989 - 02/1990	B 180 APC	B 180 EHD	B 185 APC	
F 90 32.272 VF	02/1990 - 04/1995	B 180 APC	B 180 EHD	B 185 APC	
F 90 32.272 VFK	02/1990 - 04/1995	B 180 APC	B 180 EHD	B 185 APC	
F 90 32.292 VF	03/1988 - 02/1990	B 180 APC	B 180 EHD	B 185 APC	

MARCHIO E MODELLO - MAKE AND MODEL MARQUE ET MODÈLE - MARKE UND MODELL MARCA Y MODELO - МАРКА И МОДЕЛЬ	Periodo Period	powerCUBE		energyCUBE	
		APC	EHD	APC	RST
MAN cont.					
F 90 32.292 VFK	03/1988 - 02/1990	B 180 APC	B 180 EHD	B 185 APC	
F 90 32.302 VF	05/1990 - 09/1991	B 180 APC	B 180 EHD	B 185 APC	
F 90 32.302 VFK	05/1990 - 09/1991	B 180 APC	B 180 EHD	B 185 APC	
F 90 32.322 VF	02/1990 - 06/1996	B 180 APC	B 180 EHD	B 185 APC	
F 90 32.322 VFK	02/1990 - 06/1996	B 180 APC	B 180 EHD	B 185 APC	
F 90 32.332 VF	03/1988 - 02/1990	B 180 APC	B 180 EHD	B 185 APC	
F 90 32.332 VFK	03/1988 - 02/1990	B 180 APC	B 180 EHD	B 185 APC	
F 90 32.342 VFK	05/1994 - 06/1996	B 180 APC	B 180 EHD	B 185 APC	
F 90 32.362 VF	03/1988 - 02/1990	B 180 APC	B 180 EHD	B 185 APC	
F 90 32.362 VFK	03/1988 - 02/1990	B 180 APC	B 180 EHD	B 185 APC	
F 90 32.372 VF	02/1990 - 06/1996	B 180 APC	B 180 EHD	B 185 APC	
F 90 32.372 VFK	02/1990 - 06/1996	B 180 APC	B 180 EHD	B 185 APC	
F 90 32.372 VFK	05/1990 - 04/1995	B 180 APC	B 180 EHD	B 185 APC	
F 90 32.402 VFK	05/1994 - 06/1996	B 180 APC	B 180 EHD	B 185 APC	
F 90 32.422 VF	02/1990 - 06/1996	B 180 APC	B 180 EHD	B 185 APC	
F 90 32.422 VFK	02/1990 - 06/1996	B 180 APC	B 180 EHD	B 185 APC	
F 90 33.242 DFAK	01/1988 - 08/1988	B 180 APC	B 180 EHD	B 185 APC	
F 90 33.242 DFK	01/1988 - 08/1988	B 180 APC	B 180 EHD	B 185 APC	
F 90 33.262 DF	08/1988 - 02/1990	B 180 APC	B 180 EHD	B 185 APC	
F 90 33.262 DFA	07/1989 - 02/1990	B 180 APC	B 180 EHD	B 185 APC	
F 90 33.262 DFAK	07/1989 - 02/1990	B 180 APC	B 180 EHD	B 185 APC	
F 90 33.262 DFK	08/1988 - 02/1990	B 180 APC	B 180 EHD	B 185 APC	
F 90 33.272 DF	10/1992 - 04/1995	B 180 APC	B 180 EHD	B 185 APC	
F 90 33.272 DFA	10/1992 - 04/1995	B 180 APC	B 180 EHD	B 185 APC	
F 90 33.272 FVL	10/1992 - 04/1995	B 180 APC	B 180 EHD	B 185 APC	
F 90 33.292 DF	09/1987 - 02/1990	B 180 APC	B 180 EHD	B 185 APC	
F 90 33.292 DFA	05/1988 - 02/1990	B 180 APC	B 180 EHD	B 185 APC	
F 90 33.292 DFAK	05/1988 - 02/1990	B 180 APC	B 180 EHD	B 185 APC	
F 90 33.292 DFAS	05/1988 - 02/1990	B 180 APC	B 180 EHD	B 185 APC	
F 90 33.292 DFK	09/1987 - 02/1990	B 180 APC	B 180 EHD	B 185 APC	
F 90 33.292 DFS	09/1987 - 02/1990	B 180 APC	B 180 EHD	B 185 APC	
F 90 33.322 DF	09/1991 - 06/1996	B 180 APC	B 180 EHD	B 185 APC	
F 90 33.322 DFA	09/1991 - 06/1996	B 180 APC	B 180 EHD	B 185 APC	
F 90 33.322 FVL	09/1991 - 06/1996	B 180 APC	B 180 EHD	B 185 APC	
F 90 33.332 DF	09/1987 - 02/1990	B 180 APC	B 180 EHD	B 185 APC	
F 90 33.332 DFA	05/1988 - 02/1990	B 180 APC	B 180 EHD	B 185 APC	
F 90 33.332 DFAK	05/1988 - 02/1990	B 180 APC	B 180 EHD	B 185 APC	
F 90 33.332 DFAS	05/1988 - 02/1990	B 180 APC	B 180 EHD	B 185 APC	
F 90 33.332 DFK	09/1987 - 02/1990	B 180 APC	B 180 EHD	B 185 APC	
F 90 33.332 DFS	09/1987 - 02/1990	B 180 APC	B 180 EHD	B 185 APC	
F 90 33.342 DF	05/1994 - 06/1996	B 180 APC	B 180 EHD	B 185 APC	
F 90 33.342 DFA	05/1994 - 06/1996	B 180 APC	B 180 EHD	B 185 APC	
F 90 33.362 DF	09/1987 - 02/1990	B 180 APC	B 180 EHD	B 185 APC	
F 90 33.362 DFA	05/1988 - 02/1990	B 180 APC	B 180 EHD	B 185 APC	
F 90 33.362 DFAK	05/1988 - 02/1990	B 180 APC	B 180 EHD	B 185 APC	

MARCHIO E MODELLO - MAKE AND MODEL MARQUE ET MODÈLE - MARKE UND MODELL MARCA Y MODELO - МАРКА И МОДЕЛЬ	Periodo Period	powerCUBE		energyCUBE	
		APC	EHD	APC	RST
MAN					
<i>cont.</i>					
F 90 33.362 DFAS	05/1988 - 02/1990	B 180 APC	B 180 EHD	B 185 APC	
F 90 33.362 DFK	09/1987 - 02/1990	B 180 APC	B 180 EHD	B 185 APC	
F 90 33.362 DFS	09/1987 - 02/1990	B 180 APC	B 180 EHD	B 185 APC	
F 90 33.372 DF	09/1991 - 06/1996	B 180 APC	B 180 EHD	B 185 APC	
F 90 33.372 DFA	09/1991 - 06/1996	B 180 APC	B 180 EHD	B 185 APC	
F 90 33.372 DFAK	01/1991 - 06/1996	B 180 APC	B 180 EHD	B 185 APC	
F 90 33.372 DFK	01/1991 - 06/1996	B 180 APC	B 180 EHD	B 185 APC	
F 90 33.372 DFS	09/1991 - 06/1996	B 180 APC	B 180 EHD	B 185 APC	
F 90 33.402 DF	05/1994 - 06/1996	B 180 APC	B 180 EHD	B 185 APC	
F 90 33.402 DFA	05/1994 - 06/1996	B 180 APC	B 180 EHD	B 185 APC	
F 90 33.402 DFAK	05/1994 - 06/1996	B 180 APC	B 180 EHD	B 185 APC	
F 90 33.402 DFK	05/1994 - 06/1996	B 180 APC	B 180 EHD	B 185 APC	
F 90 33.402 DFS	05/1994 - 06/1996	B 180 APC	B 180 EHD	B 185 APC	
F 90 33.422 DF	09/1991 - 06/1996	B 180 APC	B 180 EHD	B 185 APC	
F 90 33.422 DFA	09/1991 - 06/1996	B 180 APC	B 180 EHD	B 185 APC	
F 90 33.422 DFAK	01/1994 - 06/1996	B 180 APC	B 180 EHD	B 185 APC	
F 90 33.422 DFK	01/1994 - 06/1996	B 180 APC	B 180 EHD	B 185 APC	
F 90 33.422 DFS	01/1994 - 06/1996	B 180 APC	B 180 EHD	B 185 APC	
F 90 33.462 DF	07/1989 - 02/1990	B 180 APC	B 180 EHD	B 185 APC	
F 90 33.462 DFA	07/1989 - 02/1990	B 180 APC	B 180 EHD	B 185 APC	
F 90 33.502 DF	09/1991 - 06/1996	B 180 APC	B 180 EHD	B 185 APC	
F 90 33.502 DFA	09/1991 - 06/1996	B 180 APC	B 180 EHD	B 185 APC	
F 90 35.262 VF	02/1989 - 02/1990	B 180 APC	B 180 EHD	B 185 APC	
F 90 35.262 VFA	07/1989 - 02/1990	B 180 APC	B 180 EHD	B 185 APC	
F 90 35.262 VFK	02/1989 - 02/1990	B 180 APC	B 180 EHD	B 185 APC	
F 90 35.272 VF	02/1990 - 12/1991	B 180 APC	B 180 EHD	B 185 APC	
F 90 35.272 VFK	02/1990 - 12/1992	B 180 APC	B 180 EHD	B 185 APC	
F 90 35.292 VF	10/1988 - 04/1995	B 180 APC	B 180 EHD	B 185 APC	
F 90 35.292 VFK	10/1988 - 04/1995	B 180 APC	B 180 EHD	B 185 APC	
F 90 35.302 VF	05/1990 - 09/1991	B 180 APC	B 180 EHD	B 185 APC	
F 90 35.302 VFA	05/1990 - 09/1991	B 180 APC	B 180 EHD	B 185 APC	
F 90 35.302 VFAK	05/1990 - 09/1991	B 180 APC	B 180 EHD	B 185 APC	
F 90 35.302 VFK	05/1990 - 09/1991	B 180 APC	B 180 EHD	B 185 APC	
F 90 35.322 VFAK	02/1990 - 06/1996	B 180 APC	B 180 EHD	B 185 APC	
F 90 35.322 VFK	02/1990 - 06/1996	B 180 APC	B 180 EHD	B 185 APC	
F 90 35.322 VK	02/1990 - 06/1996	B 180 APC	B 180 EHD	B 185 APC	
F 90 35.332 VF	10/1988 - 04/1995	B 180 APC	B 180 EHD	B 185 APC	
F 90 35.332 VFK	10/1988 - 04/1995	B 180 APC	B 180 EHD	B 185 APC	
F 90 35.342 VF	05/1994 - 06/1996	B 180 APC	B 180 EHD	B 185 APC	
F 90 35.342 VFK	05/1994 - 06/1996	B 180 APC	B 180 EHD	B 185 APC	
F 90 35.362 VF	10/1988 - 02/1990	B 180 APC	B 180 EHD	B 185 APC	
F 90 35.362 VFK	10/1988 - 02/1990	B 180 APC	B 180 EHD	B 185 APC	
F 90 35.372 VF	02/1990 - 04/1995	B 180 APC	B 180 EHD	B 185 APC	
F 90 35.372 VFK	02/1990 - 06/1996	B 180 APC	B 180 EHD	B 185 APC	
F 90 35.372 VF	02/1990 - 12/1997	B 180 APC	B 180 EHD	B 185 APC	

MARCHIO E MODELLO - MAKE AND MODEL MARQUE ET MODÈLE - MARKE UND MODELL MARCA Y MODELO - МАРКА И МОДЕЛЬ	Periodo Period	powerCUBE		energyCUBE	
		APC	EHD	APC	RST
MAN					
	<i>cont.</i>				
F 90 35.372 VFK	02/1990 - 04/1995	B 180 APC	B 180 EHD	B 185 APC	
F 90 35.372 VFK	02/1990 - 06/1996	B 180 APC	B 180 EHD	B 185 APC	
F 90 35.372 VFK	02/1990 - 12/1997	B 180 APC	B 180 EHD	B 185 APC	
F 90 35.402 VF	05/1994 - 06/1996	B 180 APC	B 180 EHD	B 185 APC	
F 90 35.402 VF	05/1994 - 12/1997	B 180 APC	B 180 EHD	B 185 APC	
F 90 35.402 VFK	05/1994 - 06/1996	B 180 APC	B 180 EHD	B 185 APC	
F 90 35.402 VFK	05/1994 - 12/1997	B 180 APC	B 180 EHD	B 185 APC	
F 90 35.422 VF	02/1990 - 06/1996	B 180 APC	B 180 EHD	B 185 APC	
F 90 35.422 VF	02/1990 - 12/1997	B 180 APC	B 180 EHD	B 185 APC	
F 90 35.422 VFK	02/1990 - 06/1996	B 180 APC	B 180 EHD	B 185 APC	
F 90 35.422 VFK	02/1990 - 12/1997	B 180 APC	B 180 EHD	B 185 APC	
F 90 40.372 DF	12/1991 - 06/1996	B 180 APC	B 180 EHD	B 185 APC	
F 90 40.372 DFA	12/1991 - 06/1996	B 180 APC	B 180 EHD	B 185 APC	
F 90 40.402 DF	05/1995 - 06/1996	B 180 APC	B 180 EHD	B 185 APC	
F 90 40.402 DFA	05/1995 - 06/1996	B 180 APC	B 180 EHD	B 185 APC	
F 90 40.422 DF	12/1991 - 06/1996	B 180 APC	B 180 EHD	B 185 APC	
F 90 40.422 DFA	12/1991 - 06/1996	B 180 APC	B 180 EHD	B 185 APC	
F 90 40.462 DF	07/1989 - 02/1990	B 180 APC	B 180 EHD	B 185 APC	
F 90 40.462 DFA	07/1989 - 02/1990	B 180 APC	B 180 EHD	B 185 APC	
F 90 40.502 DFA	02/1990 - 06/1996	B 180 APC	B 180 EHD	B 185 APC	
F 90 41.262 VF	07/1989 - 02/1990	B 180 APC	B 180 EHD	B 185 APC	
F 90 41.262 VFK	07/1989 - 02/1990	B 180 APC	B 180 EHD	B 185 APC	
F 90 41.272 VF	02/1990 - 12/1991	B 180 APC	B 180 EHD	B 185 APC	
F 90 41.292 VF	10/1988 - 02/1990	B 180 APC	B 180 EHD	B 185 APC	
F 90 41.292 VFK	10/1988 - 02/1990	B 180 APC	B 180 EHD	B 185 APC	
F 90 41.322 VF	02/1990 - 06/1996	B 180 APC	B 180 EHD	B 185 APC	
F 90 41.332 VF	10/1988 - 02/1990	B 180 APC	B 180 EHD	B 185 APC	
F 90 41.332 VFK	10/1988 - 02/1990	B 180 APC	B 180 EHD	B 185 APC	
F 90 41.342 VF	05/1994 - 06/1996	B 180 APC	B 180 EHD	B 185 APC	
F 90 41.362 VF	10/1988 - 02/1990	B 180 APC	B 180 EHD	B 185 APC	
F 90 41.362 VFK	10/1988 - 02/1990	B 180 APC	B 180 EHD	B 185 APC	
F 90 41.372 VF	02/1990 - 06/1996	B 180 APC	B 180 EHD	B 185 APC	
F 90 41.402 VF	05/1994 - 06/1996	B 180 APC	B 180 EHD	B 185 APC	
F 90 41.422 VF	02/1990 - 06/1996	B 180 APC	B 180 EHD	B 185 APC	
F 90 48.292 VF	07/1989 - 02/1990	B 180 APC	B 180 EHD	B 185 APC	
F 90 48.292 VFA	07/1989 - 02/1990	B 180 APC	B 180 EHD	B 185 APC	
F 90 48.292 VFAK	07/1989 - 02/1990	B 180 APC	B 180 EHD	B 185 APC	
F 90 48.332 VF	07/1989 - 02/1990	B 180 APC	B 180 EHD	B 185 APC	
F 90 48.332 VFA	07/1989 - 02/1990	B 180 APC	B 180 EHD	B 185 APC	
F 90 48.332 VFAK	07/1989 - 02/1990	B 180 APC	B 180 EHD	B 185 APC	
F 90 48.362 VF	07/1989 - 02/1990	B 180 APC	B 180 EHD	B 185 APC	
F 90 48.362 VFA	07/1989 - 02/1990	B 180 APC	B 180 EHD	B 185 APC	
F 90 48.362 VFAK	07/1989 - 02/1990	B 180 APC	B 180 EHD	B 185 APC	
F 90 48.462 VF	07/1989 - 02/1990	B 180 APC	B 180 EHD	B 185 APC	
FOCL 12.240		CX 225 APC		CX 220 APC	

MARCHIO E MODELLO - MAKE AND MODEL MARQUE ET MODÈLE - MARKE UND MODELL MARCA Y MODELO - МАРКА И МОДЕЛЬ	Periodo Period	powerCUBE		energyCUBE	
		APC	EHD	APC	RST
MAN					
cont.					
FOCL 12.250		CX 225 APC		CX 220 APC	
G 10.136 F,10.136 FL	09/1981 - 09/1987	A 135 APC	A 140 EHD		
G 10.136 FK	09/1981 - 09/1987	A 135 APC	A 140 EHD		
G 6.90 F	10/1979 - 09/1987	A 135 APC	A 140 EHD		
G 6.90 FK	10/1979 - 09/1987	A 135 APC	A 140 EHD		
G 8.136 F,8.136 FL	10/1979 - 09/1987	A 135 APC	A 140 EHD		
G 8.136 FAE	12/1983 - 08/1988	A 135 APC	A 140 EHD		
G 8.136 FK	10/1979 - 08/1988	A 135 APC	A 140 EHD		
G 8.136 FOC	03/1982 - 07/1988	A 135 APC	A 140 EHD		
G 8.90 F	10/1979 - 09/1987	A 135 APC	A 140 EHD		
G 8.90 FK	10/1979 - 09/1987	A 135 APC	A 140 EHD		
G 9.136 F,9.136 FL	10/1979 - 09/1987	A 135 APC	A 140 EHD		
G 9.136 FAE	12/1983 - 08/1988	A 135 APC	A 140 EHD		
G 9.136 FK	10/1979 - 08/1988	A 135 APC	A 140 EHD		
G 9.136 FOC	03/1982 - 07/1988	A 135 APC	A 140 EHD		
G 90 10.150 F,10.150 FL	05/1990 - 10/1993	A 135 APC	A 140 EHD		
G 90 10.150 F,10.150 FL	09/1987 - 10/1993	A 135 APC	A 140 EHD		
G 90 10.150 FK	09/1987 - 10/1993	A 135 APC	A 140 EHD		
G 90 6.100 F	09/1987 - 10/1993	A 135 APC	A 140 EHD		
G 90 6.100 FK	09/1987 - 10/1993	A 135 APC	A 140 EHD		
G 90 8.100 F	09/1987 - 10/1993	A 135 APC	A 140 EHD		
G 90 8.100 FK	09/1987 - 10/1993	A 135 APC	A 140 EHD		
G 90 8.150 F,8.150 FL	05/1990 - 10/1993	A 135 APC	A 140 EHD		
G 90 8.150 F,8.150 FL	09/1987 - 10/1993	A 135 APC	A 140 EHD		
G 90 8.150 FAE	05/1988 - 05/1995	A 135 APC	A 140 EHD		
G 90 8.150 FAKO	10/1992 - 05/1995	A 135 APC	A 140 EHD		
G 90 8.150 FK	09/1987 - 10/1993	A 135 APC	A 140 EHD		
G 90 8.150 FOC	07/1988 - 10/1993	A 135 APC	A 140 EHD		
G 90 8.150 FS,8.150 FLS	09/1987 - 10/1993	A 135 APC	A 140 EHD		
G 90 8.170 FOC	02/1989 - 10/1993	A 135 APC	A 140 EHD		
G 90 9.150 F,9.150 FL	05/1990 - 10/1993	A 135 APC	A 140 EHD		
G 90 9.150 F,9.150 FL	09/1987 - 10/1993	A 135 APC	A 140 EHD		
G 90 9.150 FAE	05/1988 - 05/1992	A 135 APC	A 140 EHD		
G 90 9.150 FAKO	10/1992 - 05/1995	A 135 APC	A 140 EHD		
G 90 9.150 FK	09/1987 - 10/1993	A 135 APC	A 140 EHD		
G 90 9.150 FOC	07/1988 - 10/1993	A 135 APC	A 140 EHD		
G 90 9.150 FS,9.150 FLS	09/1987 - 10/1993	A 135 APC	A 140 EHD		
G 90 9.170 FOC	02/1989 - 10/1993	A 135 APC	A 140 EHD		
HELICON 380	01/1987 -	CX 225 APC		CX 220 APC	
HOCL 10.150 HOCL	08/1987 - 04/2004	CX 225 APC		CX 220 APC	
HOCL 10.190 HOCL	08/1987 - 04/2004	CX 225 APC		CX 220 APC	
HOCL 11.150 HOCL	08/1987 - 04/2004	CX 225 APC		CX 220 APC	
HOCL 11.190 HOCL	08/1987 - 04/2004	CX 225 APC		CX 220 APC	
HOCL 12.220 HOCL/R-NL	04/1999 - 05/2009	CX 225 APC		CX 220 APC	
HOCL 12.240 HOCL-NL		CX 225 APC		CX 220 APC	

MARCHIO E MODELLO - MAKE AND MODEL MARQUE ET MODÈLE - MARKE UND MODELL MARCA Y MODELO - МАРКА И МОДЕЛЬ	Periodo Period	powerCUBE		energyCUBE	
		APC	EHD	APC	RST
MAN					
<i>cont.</i>					
HOCL 13.220 HOCL/R	09/2001 - 04/2004	CX 225 APC		CX 220 APC	
HOCL 14.220 HOCL/R-NL	01/1998 -	CX 225 APC		CX 220 APC	
HOCL 14.240 HOCL-NL		CX 225 APC		CX 220 APC	
HOCL 14.250 HOCL-NL		CX 225 APC		CX 220 APC	
HOCL 14.280 HOCL		CX 225 APC		CX 220 APC	
HOCL 14.290 HOCL-NL		CX 225 APC		CX 220 APC	
HOCL 16.240 HOC, HOCL/R	01/1979 - 08/1996	CX 225 APC		CX 220 APC	
HOCL 16.290 HOC, HOCL/R	04/1981 - 09/1996	CX 225 APC		CX 220 APC	
HOCL 16.360 HOCL/R	01/1985 - 09/1996	CX 225 APC		CX 220 APC	
HOCL 16.372 HOCL	01/1985 - 09/1996	CX 225 APC		CX 220 APC	
HOCL 18.220 HOCL/R-NL, HOCL/SKD(SL)	08/1993 - 05/2001	CX 225 APC		CX 220 APC	
HOCL 18.240 HOCL-NL		CX 225 APC		CX 220 APC	
HOCL 18.250 HOCL-NL	0/0 - 05/2001	CX 225 APC		CX 220 APC	
HOCL 18.280 HOCL-NL	0/0 - 08/2008	CX 225 APC		CX 220 APC	
HOCL 18.290 HOCL-NL		CX 225 APC		CX 220 APC	
HOCL 18.310 HOCL/R	01/1992 -	CX 225 APC		CX 220 APC	
HOCL 18.310 HOCL-NL		CX 225 APC		CX 220 APC	
HOCL 18.320 HOCL-NL		CX 225 APC		CX 220 APC	
HOCL 18.360 HOCL		CX 225 APC		CX 220 APC	
HOCL 18.400 HOCL		CX 225 APC		CX 220 APC	
HOCL 18.430 HOCL		CX 225 APC		CX 220 APC	
HOCL 18.440 HOCL		CX 225 APC		CX 220 APC	
HOCL 18.460 HOCL		CX 225 APC		CX 220 APC	
HOCL 18.480 HOCL		CX 225 APC		CX 220 APC	
HOCL 24.440 HOCLN		CX 225 APC		CX 220 APC	
HOCL 24.460 HOCLN		CX 225 APC		CX 220 APC	
HOCL 24.480 HOCLN		CX 225 APC		CX 220 APC	
L 2000 10.145 LC,10.145 LLC (LE140C)	09/2000 -	A 135 APC	A 140 EHD		
L 2000 10.145 LK (LE140C)	09/2000 -	A 135 APC	A 140 EHD		
L 2000 10.145 LLS (LE145C)	09/2000 -	A 135 APC	A 140 EHD		
L 2000 10.150 FOC	02/1995 - 01/1996	A 135 APC	A 140 EHD		
L 2000 10.153 F	10/1993 -	A 135 APC	A 140 EHD		
L 2000 10.153 FA	10/1993 -	A 135 APC	A 140 EHD		
L 2000 10.153 LAEK	10/1993 - 06/1996	A 135 APC	A 140 EHD		
L 2000 10.153 LC,10.153 LLC	10/1993 - 06/1996	A 135 APC	A 140 EHD		
L 2000 10.153 LK	10/1993 - 06/1996	A 135 APC	A 140 EHD		
L 2000 10.153 LLS	10/1993 - 06/1996	A 135 APC	A 140 EHD		
L 2000 10.155 LK, LRK	02/2004 -	A 135 APC	A 140 EHD		
L 2000 10.163 F	05/1994 -	A 135 APC	A 140 EHD		
L 2000 10.163 FA	05/1994 -	A 135 APC	A 140 EHD		
L 2000 10.163 LAEC	05/1994 -	A 135 APC	A 140 EHD		
L 2000 10.163 LAEK	01/1995 -	A 135 APC	A 140 EHD		
L 2000 10.163 LC,10.163 LLC	05/1994 -	A 135 APC	A 140 EHD		
L 2000 10.163 LC,10.163 LLC (LE160C)	09/2000 -	A 135 APC	A 140 EHD		
L 2000 10.163 LK	05/1994 -	A 135 APC	A 140 EHD		

MARCHIO E MODELLO - MAKE AND MODEL MARQUE ET MODÈLE - MARKE UND MODELL MARCA Y MODELO - МАРКА И МОДЕЛЬ	Periodo Period	powerCUBE		energyCUBE	
		APC	EHD	APC	RST
MAN					
<i>cont.</i>					
L 2000 10.163 LLS	05/1994 -	A 135 APC	A 140 EHD		
L 2000 10.185 LAEC	09/2000 -	A 135 APC	A 140 EHD		
L 2000 10.185 LAEK (LE180C)	09/2000 -	A 135 APC	A 140 EHD		
L 2000 10.185 LC,10.185 LLC (LE180C)	09/2000 -	A 135 APC	A 140 EHD		
L 2000 10.185 LK (LE180C)	09/2000 -	A 135 APC	A 140 EHD		
L 2000 10.185 LLS (LE180C)	09/2000 -	A 135 APC	A 140 EHD		
L 2000 10.220 FOC,10.220 FOCL	02/1995 -	A 135 APC	A 140 EHD		
L 2000 10.223 F, 10.223 FL	10/1993 - 06/1996	A 135 APC	A 140 EHD		
L 2000 10.223 FA	10/1993 - 06/1996	A 135 APC	A 140 EHD		
L 2000 10.223 LAEC	01/1995 - 06/1996	A 135 APC	A 140 EHD		
L 2000 10.223 LC,10.223 LLC	10/1993 - 06/1996	A 135 APC	A 140 EHD		
L 2000 10.223 LK	10/1993 - 06/1996	A 135 APC	A 140 EHD		
L 2000 10.223 LLS	10/1993 - 06/1996	A 135 APC	A 140 EHD		
L 2000 10.224 F, 10.224 FL	05/1994 -	A 135 APC	A 140 EHD		
L 2000 10.224 FA	05/1994 -	A 135 APC	A 140 EHD		
L 2000 10.224 LAEC	01/1995 -	A 135 APC	A 140 EHD		
L 2000 10.224 LAEK	01/1995 -	A 135 APC	A 140 EHD		
L 2000 10.224 LC,10.224 LLC	05/1994 -	A 135 APC	A 140 EHD		
L 2000 10.224 LK	05/1994 -	A 135 APC	A 140 EHD		
L 2000 10.224 LLS	05/1994 -	A 135 APC	A 140 EHD		
L 2000 10.225 LAEC (LE220C)	09/2000 -	A 135 APC	A 140 EHD		
L 2000 10.225 LAEK (LE220C)	09/2000 -	A 135 APC	A 140 EHD		
L 2000 10.225 LC	09/2000 -	A 135 APC	A 140 EHD		
L 2000 10.225 LC, 10.225 LLC, LRC, LLRC	09/2000 -	A 135 APC	A 140 EHD		
L 2000 10.225 LK (LE220C)	09/2000 -	A 135 APC	A 140 EHD		
L 2000 10.225 LLS (LE220C)	09/2000 -	A 135 APC	A 140 EHD		
L 2000 12.185 LC, LLC	09/1999 -	A 135 APC	A 140 EHD		
L 2000 12.225 LC, LLC (LE220C)	09/1999 -	A 135 APC	A 140 EHD		
L 2000 8.103 LC,8.103 LLC	10/1993 - 06/1996	A 135 APC	A 140 EHD		
L 2000 8.103 LK	10/1993 - 06/1996	A 135 APC	A 140 EHD		
L 2000 8.113 LC,8.113 LLC	08/1995 -	A 135 APC	A 140 EHD		
L 2000 8.113 LK	08/1995 -	A 135 APC	A 140 EHD		
L 2000 8.145	09/2000 -	A 135 APC	A 140 EHD		
L 2000 8.145 LC,8.145 LLC (LE140C)	09/2000 -	A 135 APC	A 140 EHD		
L 2000 8.145 LLS (LE140C)	09/2000 -	A 135 APC	A 140 EHD		
L 2000 8.145, LA-LF LAE-LF	07/2000 -	A 135 APC	A 140 EHD		
L 2000 8.150 FOC,8.150 FOCL	02/1995 -	A 135 APC	A 140 EHD		
L 2000 8.153 LAEC	01/1995 - 06/1996	A 135 APC	A 140 EHD		
L 2000 8.153 LAEK	01/1995 - 09/1996	A 135 APC	A 140 EHD		
L 2000 8.153 LC,8.153 LLC	10/1993 - 07/1997	A 135 APC	A 140 EHD		
L 2000 8.153 LK	10/1993 - 07/1997	A 135 APC	A 140 EHD		
L 2000 8.153 LLS	10/1993 - 06/1996	A 135 APC	A 140 EHD		
L 2000 8.155 L, LR, LC, LLC, LRC, LLRC, L-LF	02/2004 -	A 135 APC	A 140 EHD		
L 2000 8.155 LK, LRK	02/2004 -	A 135 APC	A 140 EHD		
L 2000 8.155 LLS, LLRS	02/2004 -	A 135 APC	A 140 EHD		

MARCHIO E MODELLO - MAKE AND MODEL MARQUE ET MODÈLE - MARKE UND MODELL MARCA Y MODELO - МАРКА И МОДЕЛЬ	Periodo Period	powerCUBE		energyCUBE	
		APC	EHD	APC	RST
MAN cont.					
L 2000 8.163 LAEC	01/1995 -	A 135 APC	A 140 EHD		
L 2000 8.163 LAEC	08/1995 - 03/1997	A 135 APC	A 140 EHD		
L 2000 8.163 LAK, LARK, LAEK, LAERK	04/2000 -	A 135 APC	A 140 EHD		
L 2000 8.163 LC,8.163 LLC	05/1994 -	A 135 APC	A 140 EHD		
L 2000 8.163 LC,8.163 LLC	08/1995 -	A 135 APC	A 140 EHD		
L 2000 8.163 LC,8.163 LLC	09/2000 -	A 135 APC	A 140 EHD		
L 2000 8.163 LK	05/1994 -	A 135 APC	A 140 EHD		
L 2000 8.163 LLS	05/1994 -	A 135 APC	A 140 EHD		
L 2000 8.185 LAC	09/2000 -	A 135 APC	A 140 EHD		
L 2000 8.185 LAEC (LE180C)	09/2000 -	A 135 APC	A 140 EHD		
L 2000 8.185 LAEK	09/2000 -	A 135 APC	A 140 EHD		
L 2000 8.185 LC, 8.185 LCC	09/2000 -	A 135 APC	A 140 EHD		
L 2000 8.185 LK (LE180C)	09/2000 -	A 135 APC	A 140 EHD		
L 2000 8.185 LLS (LE180C)	09/2000 -	A 135 APC	A 140 EHD		
L 2000 8.220 FOC,8.220 FOCL	04/1995 -	A 135 APC	A 140 EHD		
L 2000 8.223 LAEC	01/1995 - 06/1996	A 135 APC	A 140 EHD		
L 2000 8.223 LC,8.223 LLC	10/1993 - 06/1996	A 135 APC	A 140 EHD		
L 2000 8.223 LK	10/1993 - 06/1996	A 135 APC	A 140 EHD		
L 2000 8.223 LLS	10/1993 - 06/1996	A 135 APC	A 140 EHD		
L 2000 8.224 LAEC	01/1995 -	A 135 APC	A 140 EHD		
L 2000 8.224 LAEK	01/1995 -	A 135 APC	A 140 EHD		
L 2000 8.224 LC,8.224 LLC	05/1994 -	A 135 APC	A 140 EHD		
L 2000 8.224 LC,8.224 LLC (LE	09/2000 -	A 135 APC	A 140 EHD		
L 2000 8.224 LK	05/1994 -	A 135 APC	A 140 EHD		
L 2000 8.224 LLS	05/1994 -	A 135 APC	A 140 EHD		
L 2000 8.225 LAEK	09/2000 -	A 135 APC	A 140 EHD		
L 2000 8.225 LK (LE220C)	09/2000 -	A 135 APC	A 140 EHD		
L 2000 8.225 LLS (LE220C)	09/2000 -	A 135 APC	A 140 EHD		
L 2000 9.145 LK (LE140C)	09/2000 -	A 135 APC	A 140 EHD		
L 2000 9.145 LLS (LE140C)	09/2000 -	A 135 APC	A 140 EHD		
L 2000 9.145LC	09/2000 -	A 135 APC	A 140 EHD		
L 2000 9.153 LC,9.153 LLC	10/1993 - 06/1996	A 135 APC	A 140 EHD		
L 2000 9.153 LK	10/1993 - 06/1996	A 135 APC	A 140 EHD		
L 2000 9.153 LLS	10/1993 - 12/1995	A 135 APC	A 140 EHD		
L 2000 9.155 L, LC, LLC, LRC, LLRC	02/2004 -	A 135 APC	A 140 EHD		
L 2000 9.155 LK, LRK	02/2004 -	A 135 APC	A 140 EHD		
L 2000 9.155 LLS, LLRS	02/2004 -	A 135 APC	A 140 EHD		
L 2000 9.163 LC	08/1995 - 03/1997	A 135 APC	A 140 EHD		
L 2000 9.163 LC,9.163 LLC	05/1994 -	A 135 APC	A 140 EHD		
L 2000 9.163 LK	05/1994 -	A 135 APC	A 140 EHD		
L 2000 9.163 LK	08/1995 - 03/1997	A 135 APC	A 140 EHD		
L 2000 9.163 LLS	05/1994 -	A 135 APC	A 140 EHD		
L 2000 9.185 LC,9.185 LLC (LE180C)	09/2000 -	A 135 APC	A 140 EHD		
L 2000 9.185 LK (LE180C)	09/2000 -	A 135 APC	A 140 EHD		
L 2000 9.185 LLS (LE 180C)	09/2000 -	A 135 APC	A 140 EHD		

MARCHIO E MODELLO - MAKE AND MODEL MARQUE ET MODÈLE - MARKE UND MODELL MARCA Y MODELO - МАРКА И МОДЕЛЬ	Periodo Period	powerCUBE		energyCUBE	
		APC	EHD	APC	RST
MAN <i>cont.</i>					
L 2000 9.223 LC,9.223 LLC	10/1993 - 06/1996	A 135 APC	A 140 EHD		
L 2000 9.223 LK	10/1993 - 06/1996	A 135 APC	A 140 EHD		
L 2000 9.223 LLS	10/1993 - 06/1996	A 135 APC	A 140 EHD		
L 2000 9.224 LC,9.224 LLC	05/1994 -	A 135 APC	A 140 EHD		
L 2000 9.224 LK	05/1994 -	A 135 APC	A 140 EHD		
L 2000 9.224 LLS	05/1994 -	A 135 APC	A 140 EHD		
L 2000 9.225 LC,9.225 LLC (LE220C)	09/2000 -	A 135 APC	A 140 EHD		
L 2000 9.225 LK (LE220C)	09/2000 -	A 135 APC	A 140 EHD		
L 2000 9.225 LLS (LE220C)	09/2000 -	A 135 APC	A 140 EHD		
L 2000 LE-C 8.113 LC	09/2000 -	A 135 APC	A 140 EHD		
LC LC 19.240		CX 225 APC		CX 220 APC	
LC LC 19.250		CX 225 APC		CX 220 APC	
LC LC 19.280		CX 225 APC		CX 220 APC	
LC LC 19.290		CX 225 APC		CX 220 APC	
LION'S CITY A 20	07/1998 -	CX 225 APC	CX 200 EHD	CX 220 APC	
LION'S CITY A 21	06/1996 -	CX 225 APC	CX 200 EHD	CX 220 APC	
LION'S CITY A 22	10/2009 -	CX 225 APC	CX 200 EHD	CX 220 APC	
LION'S CITY A 23	08/1996 -	CX 225 APC	CX 200 EHD	CX 220 APC	
LION'S CITY A 26		CX 225 APC	CX 200 EHD	CX 220 APC	
LION'S CITY A 26	02/1998 -	CX 225 APC	CX 200 EHD	CX 220 APC	
LION'S CITY A 35	10/2009 -	CX 225 APC	CX 200 EHD	CX 220 APC	
LION'S CITY A 37		CX 225 APC	CX 200 EHD	CX 220 APC	
LION'S CITY A 39		CX 225 APC	CX 200 EHD	CX 220 APC	
LION'S CITY A 66	02/2009 -	CX 225 APC	CX 200 EHD	CX 220 APC	
LION'S COACH FRH 352,RH 353	09/1995 -	CX 225 APC		CX 220 APC	
LION'S COACH FRH 402,RH 403	09/1995 -	CX 225 APC		CX 220 APC	
LION'S COACH RH 402	09/1998 -	CX 225 APC		CX 220 APC	
LION'S COACH RH 413	01/2000 -	CX 225 APC		CX 220 APC	
LION'S COACH RH 463	01/2000 -	CX 225 APC		CX 220 APC	
LION'S COACH RHC 414	06/2002 -	CX 225 APC	CX 200 EHD	CX 220 APC	
LION'S STAR FRH 352,RH 353	09/1995 -	CX 225 APC		CX 220 APC	
LION'S STAR FRH 402,RH 403	09/1995 -	CX 225 APC		CX 220 APC	
LION'S STAR FRH 422	01/1993 - 09/1996	CX 225 APC		CX 220 APC	
LION'S STAR RH 414	03/2000 -	CX 225 APC		CX 220 APC	
LION'S STAR RH 464, RHS 464	01/2002 -	CX 225 APC	CX 200 EHD	CX 220 APC	
LION'S STAR RH 464, RHS 464	03/2000 -	CX 225 APC		CX 220 APC	
LIONS COMFORT RN 313	09/1996 -	CX 225 APC		CX 220 APC	
LIONS COMFORT RN 353	06/1997 -	CX 225 APC		CX 220 APC	
Low entry 19.322 U,19.322 ULL	02/1990 - 05/1994	A 135 APC	A 140 EHD		
Low entry 19.332 U,19.322 ULL	07/1986 - 02/1990	A 135 APC	A 140 EHD		
Low entry 19.362 U,19.362 ULL	07/1986 - 01/1991	A 135 APC	A 140 EHD		
Low entry 19.372 U,19.372 ULL	02/1990 - 05/1994	A 135 APC	A 140 EHD		
Low entry 19.422 U,19.422 ULL	02/1990 - 05/1994	A 135 APC	A 140 EHD		
Low entry 24.322 UNL,24.322 UNLL	02/1990 - 12/1990	A 135 APC	A 140 EHD		
Low entry 24.332 UNL,24.332 UNLL	10/1986 - 02/1990	A 135 APC	A 140 EHD		

MARCHIO E MODELLO - MAKE AND MODEL MARQUE ET MODÈLE - MARKE UND MODELL MARCA Y MODELO - МАРКА И МОДЕЛЬ	Periodo Period	powerCUBE		energyCUBE	
		APC	EHD	APC	RST
MAN					
<i>cont.</i>					
Low entry 24.362 UNL,24.362 UNLL	10/1986 - 02/1990	A 135 APC	A 140 EHD		
Low entry 24.372 UNL,24.372 UNLL	02/1990 - 12/1990	A 135 APC	A 140 EHD		
Low entry 24.422 UNL,24.422 UNLL	02/1990 - 12/1990	A 135 APC	A 140 EHD		
Low entry 25.322 UNL,25.322 UNLL	09/1990 - 12/1992	A 135 APC	A 140 EHD		
Low entry 25.372 UNL,25.372 UNLL	09/1990 - 12/1992	A 135 APC	A 140 EHD		
Low entry 25.422 UNL,25.422 UNLL	09/1990 - 12/1992	A 135 APC	A 140 EHD		
Low entry 26.322 UNL,26.322 UNLL	09/1990 - 05/1994	A 135 APC	A 140 EHD		
Low entry 26.372 UNL,26.372 UNLL	09/1990 - 05/1994	A 135 APC	A 140 EHD		
Low entry 26.422 UNL,26.422 UNLL	09/1990 - 05/1994	A 135 APC	A 140 EHD		
M 2000 L 12.145 LC, LLC, LRC, LLRC	05/2001 -	A 135 APC	A 140 EHD		
M 2000 L 12.145 LK, LRK	05/2001 -	A 135 APC	A 140 EHD		
M 2000 L 12.163 LC,12.163 LLC	08/1995 -	A 135 APC	A 140 EHD		
M 2000 L 12.163 LK	08/1995 -	A 135 APC	A 140 EHD		
M 2000 L 12.185 LC, LLC, LRC, LLRC	05/2001 -	A 135 APC	A 140 EHD		
M 2000 L 12.185 LK, LRK	05/2001 -	A 135 APC	A 140 EHD		
M 2000 L 12.224 LC,12.224 LLC	08/1995 -	A 135 APC	A 140 EHD		
M 2000 L 12.224 LK	08/1995 -	A 135 APC	A 140 EHD		
M 2000 L 12.225 LC, LLC, LLLC, LRC, LLRC	05/2001 -	A 135 APC	A 140 EHD		
M 2000 L 12.255 LC, LLC, LLLC	08/2002 -	A 135 APC	A 140 EHD		
M 2000 L 12.255 LK	10/2003 -	A 135 APC	A 140 EHD		
M 2000 L 12.285 LC, LLC, LLLC	08/2002 -	A 135 APC	A 140 EHD		
M 2000 L 12.285 LK	10/2003 -	A 135 APC	A 140 EHD		
M 2000 L 14.163 LC,14.163 LLC	08/1995 -	A 135 APC	A 140 EHD		
M 2000 L 14.163 LK	08/1995 -	A 135 APC	A 140 EHD		
M 2000 L 14.185 LC, LLC, LRC, LLRC	05/2001 -	A 135 APC	A 140 EHD		
M 2000 L 14.185 LK, LRK	05/2001 -	A 135 APC	A 140 EHD		
M 2000 L 14.224 LAC	08/1995 -	A 135 APC	A 140 EHD		
M 2000 L 14.224 LAK	08/1995 -	A 135 APC	A 140 EHD		
M 2000 L 14.224 LC,14.224 LLC,14.224 LLLC	08/1995 -	A 135 APC	A 140 EHD		
M 2000 L 14.224 LK	08/1995 -	A 135 APC	A 140 EHD		
M 2000 L 14.224, 14.225, LA-LF	07/2003 -	A 135 APC	A 140 EHD		
M 2000 L 14.225 LAC (LE220B)	09/2000 -	A 135 APC	A 140 EHD		
M 2000 L 14.225 LAK (LE	09/2000 -	A 135 APC	A 140 EHD		
M 2000 L 14.225 LK	09/2000 -	A 135 APC	A 140 EHD		
M 2000 L 14.255 LAC, LARC	11/2002 -	A 135 APC	A 140 EHD		
M 2000 L 14.255 LAK, LARK	11/2002 -	A 135 APC	A 140 EHD		
M 2000 L 14.255 LA-LF	07/2003 -	A 135 APC	A 140 EHD		
M 2000 L 14.255 LC, LLC, LLLC (LE250B)	09/2000 -	A 135 APC	A 140 EHD		
M 2000 L 14.255 LK (LE250B)	09/2000 -	A 135 APC	A 140 EHD		
M 2000 L 14.255 LK, LRK	11/2002 -	A 135 APC	A 140 EHD		
M 2000 L 14.264 LAC	08/1995 -	A 135 APC	A 140 EHD		
M 2000 L 14.264 LAK	08/1995 -	A 135 APC	A 140 EHD		
M 2000 L 14.264 LA-LF	07/2003 -	A 135 APC	A 140 EHD		
M 2000 L 14.264 LC,14.264 LLC,14.264 LLLC	08/1995 -	A 135 APC	A 140 EHD		
M 2000 L 14.264 LK	08/1995 -	A 135 APC	A 140 EHD		

MARCHIO E MODELLO - MAKE AND MODEL MARQUE ET MODÈLE - MARKE UND MODELL MARCA Y MODELO - МАРКА И МОДЕЛЬ	Periodo Period	powerCUBE		energyCUBE	
		APC	EHD	APC	RST
MAN					
<i>cont.</i>					
M 2000 L 14.284 LAC	06/1998 -	A 135 APC	A 140 EHD		
M 2000 L 14.284 LAK	06/1998 -	A 135 APC	A 140 EHD		
M 2000 L 14.284 LA-LF	06/1998 -	A 135 APC	A 140 EHD		
M 2000 L 14.284 LC,14.284 LLC,14.284 LLLC	10/1998 -	A 135 APC	A 140 EHD		
M 2000 L 14.284 LK	10/1998 -	A 135 APC	A 140 EHD		
M 2000 L 15.163 LC,15.163 LLC	08/1995 -	A 135 APC	A 140 EHD		
M 2000 L 15.163 LK	08/1995 -	A 135 APC	A 140 EHD		
M 2000 L 15.185 LC, LRC	05/2001 -	A 135 APC	A 140 EHD		
M 2000 L 15.185 LK, LRK	11/2002 -	A 135 APC	A 140 EHD		
M 2000 L 15.224 LC,15.224 LLC,15.224 LLLC	08/1995 -	A 135 APC	A 140 EHD		
M 2000 L 15.224 LK	08/1995 -	A 135 APC	A 140 EHD		
M 2000 L 15.225 LC, LLC, LLLC (LE250B)	09/1999 -	A 135 APC	A 140 EHD		
M 2000 L 15.225 LK	09/1999 -	A 135 APC	A 140 EHD		
M 2000 L 15.255 LC, LLC, LLLC (LE250B)	09/1999 -	A 135 APC	A 140 EHD		
M 2000 L 15.255 LK	09/1999 -	A 135 APC	A 140 EHD		
M 2000 L 15.264 LC,15.264 LLC,15.264 LLLC	08/1995 -	A 135 APC	A 140 EHD		
M 2000 L 15.264 LK	08/1995 -	A 135 APC	A 140 EHD		
M 2000 L 15.284 LC,15.284 LLC,15.284 LLLC	06/1998 -	A 135 APC	A 140 EHD		
M 2000 L 15.284 LK	06/1998 -	A 135 APC	A 140 EHD		
M 2000 L 15.285 LC,LLC,LLLC (LE280B)	09/1999 -	A 135 APC	A 140 EHD		
M 2000 L 15.285 LK (LE280B)	09/1999 -	A 135 APC	A 140 EHD		
M 2000 L 18.224 LAC	08/1995 -	A 135 APC	A 140 EHD		
M 2000 L 18.224 LAK	08/1995 -	A 135 APC	A 140 EHD		
M 2000 L 18.224 LC,18.224 LLC,18.224 LLLC	08/1995 -	A 135 APC	A 140 EHD		
M 2000 L 18.224 LK,18.224 LLK	08/1995 -	A 135 APC	A 140 EHD		
M 2000 L 18.224, 18.225, L-KO, LR-KO	05/2001 -	A 135 APC	A 140 EHD		
M 2000 L 18.255 LAC, LARC	05/2001 -	A 135 APC	A 140 EHD		
M 2000 L 18.255 LAK, LARK	05/2001 -	A 135 APC	A 140 EHD		
M 2000 L 18.255 LC,LLC, LLLC	09/1999 -	A 135 APC	A 140 EHD		
M 2000 L 18.255 LK, LLK, LRK, LLRK	11/2002 -	A 135 APC	A 140 EHD		
M 2000 L 18.255 L-KO, LR-KO	05/2001 -	A 135 APC	A 140 EHD		
M 2000 L 18.263, 18.264, L-KO, LR-KO	05/2001 -	A 135 APC	A 140 EHD		
M 2000 L 18.264 LAC	08/1995 -	A 135 APC	A 140 EHD		
M 2000 L 18.264 LAK	08/1995 -	A 135 APC	A 140 EHD		
M 2000 L 18.264 LC,18.264 LLC,18.264 LLLC	08/1995 -	A 135 APC	A 140 EHD		
M 2000 L 18.264 LK,18.264 LLK	08/1995 -	A 135 APC	A 140 EHD		
M 2000 L 18.284 LAC	06/1998 -	A 135 APC	A 140 EHD		
M 2000 L 18.284 LAK	06/1998 -	A 135 APC	A 140 EHD		
M 2000 L 18.284 LC,18.284 LLC,18.284 LLLC	06/1998 -	A 135 APC	A 140 EHD		
M 2000 L 18.284 LK,18.284 LLK	06/1998 -	A 135 APC	A 140 EHD		
M 2000 L 18.284 L-KO	06/1998 -	A 135 APC	A 140 EHD		
M 2000 L 18.285 LAC (LE280B)	09/1999 -	A 135 APC	A 140 EHD		
M 2000 L 18.285 LAK (LE280B)	09/1999 -	A 135 APC	A 140 EHD		
M 2000 L 18.285 LC, LLC, LLLC (LE280B)	09/1999 -	A 135 APC	A 140 EHD		
M 2000 L 19.224, 19.225, LLC	05/2001 -	A 135 APC	A 140 EHD		

MARCHIO E MODELLO - MAKE AND MODEL MARQUE ET MODÈLE - MARKE UND MODELL MARCA Y MODELO - МАРКА И МОДЕЛЬ	Periodo Period	powerCUBE		energyCUBE	
		APC	EHD	APC	RST
MAN					
<i>cont.</i>					
M 2000 L 19.255 LLC	05/2001 -	A 135 APC	A 140 EHD		
M 2000 L 19.264 LLC	05/2001 -	A 135 APC	A 140 EHD		
M 2000 L 19.284, 19.285, LLC	05/2001 -	A 135 APC	A 140 EHD		
M 2000 L 20.224 LNLC, LNLLC	05/2001 -	A 135 APC	A 140 EHD		
M 2000 L 20.255 LNLC, LNLLC	05/2001 -	A 135 APC	A 140 EHD		
M 2000 L 20.264 LNLC, LNLLC	05/2001 -	A 135 APC	A 140 EHD		
M 2000 L 20.284, 20.285, LNLC, LNLLC	05/2001 -	A 135 APC	A 140 EHD		
M 2000 L 26.224, 26.225, DL-HK, DLR-HK	11/2002 -	A 135 APC	A 140 EHD		
M 2000 L 26.255 DL-HK, DLR-HK	11/2002 -	A 135 APC	A 140 EHD		
M 2000 L 26.284 DL-TM, DLR-TM	05/2001 -	A 135 APC	A 140 EHD		
M 2000 L 26.284, 26.285, DL-HK, DLR-HK	11/2002 -	A 135 APC	A 140 EHD		
M 2000 L 26.285 DL-TM, DLR-TM	05/2001 -	A 135 APC	A 140 EHD		
M 2000 L LE	09/2000 -	A 135 APC	A 140 EHD		
M 2000 M 12.224 MC, MLC	02/2003 -	A 135 APC	A 140 EHD		
M 2000 M 12.224 MLS	02/2003 -	A 135 APC	A 140 EHD		
M 2000 M 12.255 MC, MLC	02/2003 -	A 135 APC	A 140 EHD		
M 2000 M 12.255 MLS	02/2003 -	A 135 APC	A 140 EHD		
M 2000 M 12.264 MC, MLC	02/2003 -	A 135 APC	A 140 EHD		
M 2000 M 12.264 MLS	02/2003 -	A 135 APC	A 140 EHD		
M 2000 M 12.284 MC, MLC	02/2000 -	A 135 APC	A 140 EHD		
M 2000 M 12.284 MLS	02/2000 -	A 135 APC	A 140 EHD		
M 2000 M 14.224 MAK	08/1995 - 12/2005	A 135 APC	A 140 EHD		
M 2000 M 14.224 MA-KO, MA-LF	11/2002 -	A 135 APC	A 140 EHD		
M 2000 M 14.224 MC, 14.224 MLC, 14.224 MLLC	08/1995 - 12/2005	A 135 APC	A 140 EHD		
M 2000 M 14.224 MK	08/1995 - 12/2005	A 135 APC	A 140 EHD		
M 2000 M 14.224 MLS	08/1995 - 12/2005	A 135 APC	A 140 EHD		
M 2000 M 14.225 MC, MLC, MLLC	10/2000 -	A 135 APC	A 140 EHD		
M 2000 M 14.225 MLS, MLRS	02/2003 -	A 135 APC	A 140 EHD		
M 2000 M 14.255 MAK	11/2002 -	A 135 APC	A 140 EHD		
M 2000 M 14.255 MA-KO, MA-LF	11/2002 -	A 135 APC	A 140 EHD		
M 2000 M 14.255 MC, MLC, MLLC	10/2000 -	A 135 APC	A 140 EHD		
M 2000 M 14.255 MLS, MLRS	10/2000 -	A 135 APC	A 140 EHD		
M 2000 M 14.264 MAK	11/2002 -	A 135 APC	A 140 EHD		
M 2000 M 14.264 MA-KO, MA-LF	11/2002 -	A 135 APC	A 140 EHD		
M 2000 M 14.264 MC, 14.264 MLC, 14.264 MLLC	08/1995 - 12/2005	A 135 APC	A 140 EHD		
M 2000 M 14.264 MLS	08/1995 - 12/2005	A 135 APC	A 140 EHD		
M 2000 M 14.284 MAK	06/1998 - 12/2005	A 135 APC	A 140 EHD		
M 2000 M 14.284 MA-KO, 14.284 MA-LF	06/1998 - 12/2005	A 135 APC	A 140 EHD		
M 2000 M 14.284 MC, 14.284 MLC, 14.284 MLLC	06/1998 - 12/2005	A 135 APC	A 140 EHD		
M 2000 M 14.284 MLS	06/1998 - 12/2005	A 135 APC	A 140 EHD		
M 2000 M 14.285 MLC, MLLC (ME280C)	09/1999 - 12/2005	A 135 APC	A 140 EHD		
M 2000 M 14.285 MLS, MLRS	02/2003 -	A 135 APC	A 140 EHD		
M 2000 M 18.224 MAC	08/1995 - 12/2005	A 135 APC	A 140 EHD		
M 2000 M 18.224 MAK	08/1995 - 12/2005	A 135 APC	A 140 EHD		
M 2000 M 18.224 MC, 18.224 MLC, 18.224 MLLC	08/1995 - 12/2005	A 135 APC	A 140 EHD		

MARCHIO E MODELLO - MAKE AND MODEL MARQUE ET MODÈLE - MARKE UND MODELL MARCA Y MODELO - МАРКА И МОДЕЛЬ	Periodo Period	powerCUBE		energyCUBE	
		APC	EHD	APC	RST
MAN					
<i>cont.</i>					
M 2000 M 18.224 MK,18.224 MLK	08/1995 - 12/2005	A 135 APC	A 140 EHD		
M 2000 M 18.224 M-KO, MR-KO	02/2000 -	A 135 APC	A 140 EHD		
M 2000 M 18.224 MLS	08/1995 - 12/2005	A 135 APC	A 140 EHD		
M 2000 M 18.225 MAC, MARC	02/2003 -	A 135 APC	A 140 EHD		
M 2000 M 18.225 MC, MLC, MLLC, MRC, MLRC, MLLRC	10/2000 -	A 135 APC	A 140 EHD		
M 2000 M 18.255 MAC, MARC	10/2000 -	A 135 APC	A 140 EHD		
M 2000 M 18.255 MAK, MARK	10/2000 -	A 135 APC	A 140 EHD		
M 2000 M 18.255 MC, MLC, MLLC, MLRC, MLLRC	10/2000 -	A 135 APC	A 140 EHD		
M 2000 M 18.255 MK, MLK, MRK, MLRK	11/2002 -	A 135 APC	A 140 EHD		
M 2000 M 18.255 M-KO, MR-KO	10/2000 -	A 135 APC	A 140 EHD		
M 2000 M 18.255 MLS, MLRS	10/2000 -	A 135 APC	A 140 EHD		
M 2000 M 18.264 MAC	08/1995 - 12/2005	A 135 APC	A 140 EHD		
M 2000 M 18.264 MAK	08/1995 - 12/2005	A 135 APC	A 140 EHD		
M 2000 M 18.264 MC,18.264 MLC,18.264 MLLC	08/1995 - 12/2005	A 135 APC	A 140 EHD		
M 2000 M 18.264 MK,18.264 MLK	08/1995 - 12/2005	A 135 APC	A 140 EHD		
M 2000 M 18.264 M-KO, MR-KO	02/2000 -	A 135 APC	A 140 EHD		
M 2000 M 18.264 MLS	08/1995 - 12/2005	A 135 APC	A 140 EHD		
M 2000 M 18.284 MAC	06/1998 - 12/2005	A 135 APC	A 140 EHD		
M 2000 M 18.284 MAK	06/1998 - 12/2005	A 135 APC	A 140 EHD		
M 2000 M 18.284 MC,18.284 MLC,18.284 MLLC	06/1998 - 12/2005	A 135 APC	A 140 EHD		
M 2000 M 18.284 MK,18.284 MLK	06/1998 - 12/2005	A 135 APC	A 140 EHD		
M 2000 M 18.284 M-KO, MR-KO	02/2000 -	A 135 APC	A 140 EHD		
M 2000 M 18.284 MLS	06/1998 - 12/2005	A 135 APC	A 140 EHD		
M 2000 M 18.285 MAC, MARC	02/2003 -	A 135 APC	A 140 EHD		
M 2000 M 18.285 MC, MLC, MLLC	06/1998 - 12/2005	A 135 APC	A 140 EHD		
M 2000 M 18.285 MLS, MLRS	02/2003 -	A 135 APC	A 140 EHD		
M 2000 M 25.224 MNLC,25.224 MNLLC,25.224 MVLC	08/1995 - 12/2005	A 135 APC	A 140 EHD		
M 2000 M 25.225 MNLC, MNLLC, MNLRC, MNLLRC, MVLC	02/2003 -	A 135 APC	A 140 EHD		
M 2000 M 25.255 MNLC, MNLLC, MNLRC, MNLLRC, MVLC	10/2000 -	A 135 APC	A 140 EHD		
M 2000 M 25.264 MNLC,25.264 MNLLC,25.264 MVLC	08/1995 - 12/2005	A 135 APC	A 140 EHD		
M 2000 M 25.284 MNLC, MNLLC, MNLRC, MNLLRC, MVLC	02/2000 -	A 135 APC	A 140 EHD		
M 2000 M 25.285 MNLC, MNLLC, MNLRC, MNLLRC, MVLC	02/2003 -	A 135 APC	A 140 EHD		
M 90 12.152 F,12.152 FL	12/1988 - 05/1994	A 135 APC	A 140 EHD		
M 90 12.152 FK	12/1988 - 05/1994	A 135 APC	A 140 EHD		
M 90 12.152 FS,12.152 FLS	12/1988 - 05/1994	A 135 APC	A 140 EHD		
M 90 12.192 F,12.192 FL	07/1990 - 06/1996	A 135 APC	A 140 EHD		
M 90 12.192 FA	10/1992 - 06/1996	A 135 APC	A 140 EHD		
M 90 12.192 FAK	10/1992 - 06/1996	A 135 APC	A 140 EHD		
M 90 12.192 FK	07/1990 - 06/1996	A 135 APC	A 140 EHD		
M 90 12.192 FS,12.192 FLS	07/1990 - 06/1996	A 135 APC	A 140 EHD		
M 90 12.222 F,12.222 FL	05/1994 - 06/1996	A 135 APC	A 140 EHD		
M 90 12.222 FA	05/1994 - 06/1996	A 135 APC	A 140 EHD		
M 90 12.222 FAK	05/1994 - 06/1996	A 135 APC	A 140 EHD		
M 90 12.222 FK	05/1994 - 06/1996	A 135 APC	A 140 EHD		
M 90 12.222 FLS	05/1994 - 06/1996	A 135 APC	A 140 EHD		

MARCHIO E MODELLO - MAKE AND MODEL MARQUE ET MODÈLE - MARKE UND MODELL MARCA Y MODELO - МАРКА И МОДЕЛЬ	Periodo Period	powerCUBE		energyCUBE	
		APC	EHD	APC	RST
MAN					
<i>cont.</i>					
M 90 12.232 F,12.232 FL	08/1988 - 06/1996	A 135 APC	A 140 EHD		
M 90 12.232 FA	05/1990 - 06/1996	A 135 APC	A 140 EHD		
M 90 12.232 FAK	05/1990 - 06/1996	A 135 APC	A 140 EHD		
M 90 12.232 FK	08/1988 - 06/1996	A 135 APC	A 140 EHD		
M 90 12.232 FS,12.232 FLS	08/1988 - 06/1996	A 135 APC	A 140 EHD		
M 90 12.262 F,12.262 FL	08/1995 - 06/1996	A 135 APC	A 140 EHD		
M 90 12.262 FK	08/1995 - 06/1996	A 135 APC	A 140 EHD		
M 90 12.262 FS,12.262 FLS	08/1995 - 06/1996	A 135 APC	A 140 EHD		
M 90 12.272 F,12.272 FL	09/1991 - 10/1992	A 135 APC	A 140 EHD		
M 90 12.272 F,12.272 FL	10/1992 - 06/1996	A 135 APC	A 140 EHD		
M 90 12.272 FA	10/1993 - 04/1995	A 135 APC	A 140 EHD		
M 90 12.272 FAK	10/1993 - 04/1995	A 135 APC	A 140 EHD		
M 90 12.272 FK	09/1991 - 10/1992	A 135 APC	A 140 EHD		
M 90 12.272 FK	10/1992 - 06/1996	A 135 APC	A 140 EHD		
M 90 12.272 FS,12.272 FLS	09/1991 - 10/1992	A 135 APC	A 140 EHD		
M 90 12.272 FS,12.272 FLS	10/1992 - 06/1996	A 135 APC	A 140 EHD		
M 90 14.152 F,14.152 FL	05/1994 - 06/1996	A 135 APC	A 140 EHD		
M 90 14.152 F,14.152 FL	12/1988 - 04/1994	A 135 APC	A 140 EHD		
M 90 14.152 FK	05/1994 - 06/1996	A 135 APC	A 140 EHD		
M 90 14.152 FK	12/1988 - 05/1994	A 135 APC	A 140 EHD		
M 90 14.152 FS,14.152 FLS	05/1994 - 06/1996	A 135 APC	A 140 EHD		
M 90 14.152 FS,14.152 FLS	12/1988 - 05/1994	A 135 APC	A 140 EHD		
M 90 14.162 F,14.162 FL	08/1995 - 06/1996	A 135 APC	A 140 EHD		
M 90 14.162 FK	08/1995 - 06/1996	A 135 APC	A 140 EHD		
M 90 14.162 FS,14.162 FLS	08/1995 - 06/1996	A 135 APC	A 140 EHD		
M 90 14.192 F,14.192 FL	07/1990 - 06/1996	A 135 APC	A 140 EHD		
M 90 14.192 F,14.192 FL	08/1988 - 06/1990	A 135 APC	A 140 EHD		
M 90 14.192 FA	08/1988 - 06/1990	A 135 APC	A 140 EHD		
M 90 14.192 FK	07/1990 - 06/1996	A 135 APC	A 140 EHD		
M 90 14.192 FK	08/1988 - 06/1990	A 135 APC	A 140 EHD		
M 90 14.192 FS,14.192 FLS	07/1990 - 06/1996	A 135 APC	A 140 EHD		
M 90 14.192 FS,14.192 FLS	08/1988 - 06/1990	A 135 APC	A 140 EHD		
M 90 14.222 F,14.222 FL	05/1994 - 06/1996	A 135 APC	A 140 EHD		
M 90 14.222 FK	05/1994 - 06/1996	A 135 APC	A 140 EHD		
M 90 14.222 FLS	05/1994 - 06/1996	A 135 APC	A 140 EHD		
M 90 14.232 F,14.232 FL	05/1990 - 04/1995	A 135 APC	A 140 EHD		
M 90 14.232 F,14.232 FL	08/1988 - 06/1996	A 135 APC	A 140 EHD		
M 90 14.232 FK	08/1988 - 06/1996	A 135 APC	A 140 EHD		
M 90 14.232 FS,14.232 FLS	05/1990 - 04/1995	A 135 APC	A 140 EHD		
M 90 14.232 FS,14.232 FLS	08/1988 - 06/1996	A 135 APC	A 140 EHD		
M 90 14.262 F,14.262 FL	08/1995 - 06/1996	A 135 APC	A 140 EHD		
M 90 14.262 FK	08/1995 - 06/1996	A 135 APC	A 140 EHD		
M 90 14.262 FS,14.262 FLS	08/1995 - 06/1996	A 135 APC	A 140 EHD		
M 90 14.272 F,14.272 FL	09/1991 - 10/1992	A 135 APC	A 140 EHD		
M 90 14.272 F,14.272 FL	10/1992 - 06/1996	A 135 APC	A 140 EHD		

MARCHIO E MODELLO - MAKE AND MODEL MARQUE ET MODÈLE - MARKE UND MODELL MARCA Y MODELO - МАРКА И МОДЕЛЬ	Periodo Period	powerCUBE		energyCUBE	
		APC	EHD	APC	RST
MAN					
<i>cont.</i>					
M 90 14.272 FK	09/1991 - 10/1992	A 135 APC	A 140 EHD		
M 90 14.272 FK	10/1992 - 06/1996	A 135 APC	A 140 EHD		
M 90 14.272 FS,14.272 FLS	09/1991 - 10/1992	A 135 APC	A 140 EHD		
M 90 14.272 FS,14.272 FLS	12/1992 - 06/1996	A 135 APC	A 140 EHD		
M 90 17.192 F,17.192 FL	07/1990 - 04/1995	A 135 APC	A 140 EHD		
M 90 17.192 F,17.192 FL	08/1988 - 06/1990	A 135 APC	A 140 EHD		
M 90 17.192 FA	02/1989 - 06/1990	A 135 APC	A 140 EHD		
M 90 17.192 FA	07/1990 - 06/1996	A 135 APC	A 140 EHD		
M 90 17.192 FAK	02/1989 - 06/1990	A 135 APC	A 140 EHD		
M 90 17.192 FAK	07/1990 - 06/1996	A 135 APC	A 140 EHD		
M 90 17.192 FK	07/1990 - 01/1991	A 135 APC	A 140 EHD		
M 90 17.192 FK	08/1988 - 06/1990	A 135 APC	A 140 EHD		
M 90 17.192 FS,17.192 FLS	07/1990 - 04/1995	A 135 APC	A 140 EHD		
M 90 17.192 FS,17.192 FLS	08/1988 - 06/1990	A 135 APC	A 140 EHD		
M 90 17.222 FA	05/1994 - 06/1996	A 135 APC	A 140 EHD		
M 90 17.222 FAK	05/1994 - 06/1996	A 135 APC	A 140 EHD		
M 90 17.232 F,17.232 FL	05/1990 - 04/1995	A 135 APC	A 140 EHD		
M 90 17.232 F,17.232 FL	08/1988 - 04/1995	A 135 APC	A 140 EHD		
M 90 17.232 FA	02/1989 - 06/1996	A 135 APC	A 140 EHD		
M 90 17.232 FA	05/1990 - 04/1995	A 135 APC	A 140 EHD		
M 90 17.232 FAK	02/1989 - 06/1996	A 135 APC	A 140 EHD		
M 90 17.232 FAK	05/1990 - 04/1995	A 135 APC	A 140 EHD		
M 90 17.232 FK	05/1990 - 01/1991	A 135 APC	A 140 EHD		
M 90 17.232 FK	08/1988 - 01/1991	A 135 APC	A 140 EHD		
M 90 17.232 FS,17.232 FLS	05/1990 - 04/1995	A 135 APC	A 140 EHD		
M 90 17.232 FS,17.232 FLS	08/1988 - 04/1995	A 135 APC	A 140 EHD		
M 90 17.272 FLS	09/1991 - 05/1995	A 135 APC	A 140 EHD		
M 90 17.272 FLS	10/1992 - 05/1995	A 135 APC	A 140 EHD		
M 90 18.192 F,18.192 FL,18.192 FLL	09/1990 - 06/1996	A 135 APC	A 140 EHD		
M 90 18.192 FK	09/1990 - 06/1996	A 135 APC	A 140 EHD		
M 90 18.222 F,18.222 FL,18.222 FLL	05/1994 - 06/1996	A 135 APC	A 140 EHD		
M 90 18.222 FK	05/1994 - 06/1996	A 135 APC	A 140 EHD		
M 90 18.232 F,18.232 FL,18.232 FLL	09/1990 - 06/1996	A 135 APC	A 140 EHD		
M 90 18.232 FK	09/1990 - 06/1996	A 135 APC	A 140 EHD		
M 90 18.262 F,18.262 FL,18.262 FLL	08/1995 - 06/1996	A 135 APC	A 140 EHD		
M 90 18.262 FK	08/1995 - 06/1996	A 135 APC	A 140 EHD		
M 90 18.272 F,18.272 FL,18.272 FLL	09/1991 - 05/1994	A 135 APC	A 140 EHD		
M 90 18.272 F,18.272 FL,18.272 FLL	10/1992 - 06/1996	A 135 APC	A 140 EHD		
M 90 18.272 FK	09/1991 - 05/1994	A 135 APC	A 140 EHD		
M 90 18.272 FK	10/1992 - 06/1996	A 135 APC	A 140 EHD		
M 90 24.192 FNL,24.192 FNLL,24.192 FVL	07/1989 - 06/1996	A 135 APC	A 140 EHD		
M 90 24.222 FNL,24.222 FNLL,24.222 FVL	05/1994 - 06/1996	A 135 APC	A 140 EHD		
M 90 24.232 FNL	05/1990 - 04/1995	A 135 APC	A 140 EHD		
M 90 24.232 FNL,24.232 FNLL,24.232 FVL	07/1989 - 06/1996	A 135 APC	A 140 EHD		
M 90 24.262 FNL,24.262 FNLL,24.262 FVL	08/1995 - 06/1996	A 135 APC	A 140 EHD		

MARCHIO E MODELLO - <i>MAKE AND MODEL</i> MARQUE ET MODÈLE - <i>MARKE UND MODELL</i> MARCA Y MODELO - <i>МАРКА И МОДЕЛЬ</i>	Periodo <i>Period</i>	powerCUBE		energyCUBE	
		APC	EHD	APC	RST
MAN <small>cont.</small>					
M 90 24.272 FNL,24.272 FNLL,24.272 FVL	10/1992 - 06/1996	A 135 APC	A 140 EHD		
M 90 24.272 FNL,24.272 FVL	09/1991 - 05/1994	A 135 APC	A 140 EHD		
NG NG 262	06/1997 - 07/1998	B 180 APC	B 180 EHD	B 185 APC	
NG NG 262,NG 263	07/1998 -	B 180 APC	B 180 EHD	B 185 APC	
NG NG 262,NG 272	08/1992 - 07/1998	B 180 APC	B 180 EHD	B 185 APC	
NG NG 312	09/1995 - 07/1998	B 180 APC	B 180 EHD	B 185 APC	
NG NG 312,NG 313	07/1998 -	B 180 APC	B 180 EHD	B 185 APC	
NG NG 313		B 180 APC	B 180 EHD	B 185 APC	
NG NG 323		B 180 APC	B 180 EHD	B 185 APC	
NG NG 353		B 180 APC	B 180 EHD	B 185 APC	
NG NG 363		B 180 APC	B 180 EHD	B 185 APC	
NL NL 202	09/1989 - 04/1994	B 180 APC	B 180 EHD	B 185 APC	
NL NL 202,NL 222,NL 223	08/1992 -	B 180 APC	B 180 EHD	B 185 APC	
NL NL 202,NL 262,NL 263	04/1991 -	B 180 APC	B 180 EHD	B 185 APC	
NL NL 243		B 180 APC	B 180 EHD	B 185 APC	
NL NL 262	06/1997 -	B 180 APC	B 180 EHD	B 185 APC	
NL NL 262,NL 263	07/1998 -	B 180 APC	B 180 EHD	B 185 APC	
NL NL 273		B 180 APC	B 180 EHD	B 185 APC	
NL NL 283		B 180 APC	B 180 EHD	B 185 APC	
NL NL 312	11/1995 - 07/1998	B 180 APC	B 180 EHD	B 185 APC	
NL NL 313		B 180 APC	B 180 EHD	B 185 APC	
NL NL 313	07/1998 -	B 180 APC	B 180 EHD	B 185 APC	
NL NL 323		B 180 APC	B 180 EHD	B 185 APC	
NM 223	08/1987 -	B 180 APC	B 180 EHD	B 185 APC	
NM NM 152	04/1992 - 03/1997	A 135 APC	A 140 EHD		
NM NM 152	05/1990 - 10/1993	A 135 APC	A 140 EHD		
NM NM 182,NM 192	05/1990 - 03/1997	B 180 APC	B 180 EHD	B 185 APC	
NM NM 222,NM 223	02/1996 -	B 180 APC	B 180 EHD	B 185 APC	
NM NM 243			D11 135 EHD		
NM NM 253			D11 135 EHD		
NM NM 283			D11 135 EHD		
NM NM 293			D11 135 EHD		
NÜ NÜ 263	07/1998 -	B 180 APC	B 180 EHD	B 185 APC	
NÜ NÜ 263	09/1996 - 07/1998	B 180 APC	B 180 EHD	B 185 APC	
NÜ NÜ 313	07/1998 -	B 180 APC	B 180 EHD	B 185 APC	
NÜ NÜ 313 15M	07/1998 -	B 180 APC	B 180 EHD	B 185 APC	
NÜ NÜ 353 15M	07/1998 -	B 180 APC	B 180 EHD	B 185 APC	
R FRH 362	05/1985 - 12/1992	CX 225 APC		CX 220 APC	
R R 292,FR 292,FRH 292	05/1985 - 01/1993	CX 225 APC		CX 220 APC	
SD SD 200	04/1974 - 09/1975	B 180 APC	B 180 EHD	B 185 APC	
SD SD 200	06/1979 - 12/1986	B 180 APC	B 180 EHD	B 185 APC	
SD SD 200	10/1975 - 04/1980	B 180 APC	B 180 EHD	B 185 APC	
SD SD 200	10/1975 - 11/1986	B 180 APC	B 180 EHD	B 185 APC	
SD SD 202	10/1985 - 04/1994	B 180 APC	B 180 EHD	B 185 APC	
SG SG 220	05/1980 - 01/1985	B 180 APC	B 180 EHD	B 185 APC	

MARCHIO E MODELLO - MAKE AND MODEL MARQUE ET MODÈLE - MARKE UND MODELL MARCA Y MODELO - МАРКА И МОДЕЛЬ	Periodo Period	powerCUBE		energyCUBE	
		APC	EHD	APC	RST
MAN <small>cont.</small>					
SG SG 220	07/1976 - 04/1980	B 180 APC	B 180 EHD	B 185 APC	
SG SG 220,SG 240 HÜ,SG 242 H	05/1980 - 01/1986	B 180 APC	B 180 EHD	B 185 APC	
SG SG 240 H,SG 242,SG 242 H	09/1985 - 04/1994	B 180 APC	B 180 EHD	B 185 APC	
SG SG 240 H,SG 292 H	11/1984 - 09/1989	B 180 APC	B 180 EHD	B 185 APC	
SG SG 240 HÜ	09/1981 - 01/1986	B 180 APC	B 180 EHD	B 185 APC	
SG SG 242,SG 292	09/1985 - 04/1994	B 180 APC	B 180 EHD	B 185 APC	
SG SG 312,SG 322	02/1994 - 06/1997	B 180 APC	B 180 EHD	B 185 APC	
SG SGG 280 H	01/1982 -	B 180 APC	B 180 EHD	B 185 APC	
SL SL 200	01/1986 - 04/1987	B 180 APC	B 180 EHD	B 185 APC	
SL SL 200	05/1980 - 01/1986	B 180 APC	B 180 EHD	B 185 APC	
SL SL 200	05/1980 - 04/1987	B 180 APC	B 180 EHD	B 185 APC	
SL II SL 202	06/1984 - 04/1993	B 180 APC	B 180 EHD	B 185 APC	
SL II SL 202	06/1984 - 04/1994	B 180 APC	B 180 EHD	B 185 APC	
SL II SL 283		B 180 APC	B 180 EHD	B 185 APC	
SL II SL 353		B 180 APC	B 180 EHD	B 185 APC	
SL II SL 363		B 180 APC	B 180 EHD	B 185 APC	
SM SM 152	11/1987 - 04/1994	A 135 APC	A 140 EHD		
SM SM 182,SM 192	11/1987 - 02/1995	B 180 APC	B 180 EHD	B 185 APC	
SR SR 240	10/1975 - 06/1983	B 180 APC	B 180 EHD	B 185 APC	
SR SR 280,SR 280 H	01/1977 - 11/1986	B 180 APC	B 180 EHD	B 185 APC	
SR SR 321 H	03/1982 - 11/1986	B 180 APC	B 180 EHD	B 185 APC	
SÜ SÜ 240	01/1986 - 09/1989	B 180 APC	B 180 EHD	B 185 APC	
SÜ SÜ 240	05/1980 - 09/1989	B 180 APC	B 180 EHD	B 185 APC	
SÜ SÜ 240	10/1975 - 01/1986	B 180 APC	B 180 EHD	B 185 APC	
SÜ SÜ 240	11/1982 - 01/1986	B 180 APC	B 180 EHD	B 185 APC	
SÜ SÜ 242	01/1987 - 04/1993	B 180 APC	B 180 EHD	B 185 APC	
SÜ SÜ 243		B 180 APC	B 180 EHD	B 185 APC	
SÜ SÜ 263		B 180 APC	B 180 EHD	B 185 APC	
SÜ SÜ 263	09/2003 -	B 180 APC	B 180 EHD	B 185 APC	
SÜ SÜ 272	04/1993 - 05/1995	B 180 APC	B 180 EHD	B 185 APC	
SÜ SÜ 273		B 180 APC	B 180 EHD	B 185 APC	
SÜ SÜ 283	09/2003 -	B 180 APC	B 180 EHD	B 185 APC	
SÜ SÜ 292	04/1992 - 04/1993	B 180 APC	B 180 EHD	B 185 APC	
SÜ SÜ 293	09/2003 -	B 180 APC	B 180 EHD	B 185 APC	
SÜ SÜ 313		B 180 APC	B 180 EHD	B 185 APC	
SÜ SÜ 313	09/2003 -	B 180 APC	B 180 EHD	B 185 APC	
SÜ SÜ 320	09/2003 -	B 180 APC	B 180 EHD	B 185 APC	
SÜ SÜ 322	05/1995 - 06/1997	B 180 APC	B 180 EHD	B 185 APC	
SÜ SÜ 353		B 180 APC	B 180 EHD	B 185 APC	
SÜ SÜ 360		B 180 APC	B 180 EHD	B 185 APC	
TGA 18.310 FAC	05/2004 -	B 180 APC	B 180 EHD	B 185 APC	
TGA 18.310 FAC	09/2002 -	B 180 APC	B 180 EHD	B 185 APC	
TGA 18.310 FAK	09/2002 -	B 180 APC	B 180 EHD	B 185 APC	
TGA 18.310 FAK, FAK-L, FALK, FALK-L	05/2004 -	B 180 APC	B 180 EHD	B 185 APC	
TGA 18.310 FAS	05/2004 -	B 180 APC	B 180 EHD	B 185 APC	

MARCHIO E MODELLO - MAKE AND MODEL MARQUE ET MODÈLE - MARKE UND MODELL MARCA Y MODELO - МАРКА И МОДЕЛЬ	Periodo Period	powerCUBE		energyCUBE	
		APC	EHD	APC	RST
MAN					
<i>cont.</i>					
TGA 18.310 FAS	09/2002 -	B 180 APC	B 180 EHD	B 185 APC	
TGA 18.310 FC, FLC, FLLC, FLLC/N, FLLW, FLLW/N	05/2004 -	B 180 APC	B 180 EHD	B 185 APC	
TGA 18.310 FC,18.310 FLC,18.310 FLLC,18.310 FLLW	04/2000 -	B 180 APC	B 180 EHD	B 185 APC	
TGA 18.310 FLLS,18.310 FLLS/N	04/2000 -	B 180 APC	B 180 EHD	B 185 APC	
TGA 18.310 FLS, FLLS	05/2004 -	B 180 APC	B 180 EHD	B 185 APC	
TGA 18.310, 18.320 FK, FLK, FLK/M	05/2004 -	B 180 APC	B 180 EHD	B 185 APC	
TGA 18.350 FAC	05/2004 -	B 180 APC	B 180 EHD	B 185 APC	
TGA 18.350 FAK, FAK-L, FALK, FALK-L	05/2004 -	B 180 APC	B 180 EHD	B 185 APC	
TGA 18.350 FAS, FALS	05/2004 -	B 180 APC	B 180 EHD	B 185 APC	
TGA 18.350 FC, FLC, FLLC, FLLC/N, FLLW, FLLW/N	05/2004 -	B 180 APC	B 180 EHD	B 185 APC	
TGA 18.350 FK, FK-L, FLK, FLK/M,	05/2004 -	B 180 APC	B 180 EHD	B 185 APC	
TGA 18.350 FLS, FLS/N, FLS/M, FLS-TS, FLLS, FLLS/N	05/2004 -	B 180 APC	B 180 EHD	B 185 APC	
TGA 18.360 FAC	09/2002 -	B 180 APC	B 180 EHD	B 185 APC	
TGA 18.360 FAK, FALK, FAK-L, FALK-L	09/2002 -	B 180 APC	B 180 EHD	B 185 APC	
TGA 18.360 FAS, FALS	09/2002 -	B 180 APC	B 180 EHD	B 185 APC	
TGA 18.360 FC,18.360 FLC,18.360 FLLC,18.360 FLLW	04/2000 -	B 180 APC	B 180 EHD	B 185 APC	
TGA 18.360 FK,18.360 FLK	12/2000 -	B 180 APC	B 180 EHD	B 185 APC	
TGA 18.360 FLS, FLLS, FLRS, FLLRS	01/2006 -	B 180 APC	B 180 EHD	B 185 APC	
TGA 18.360 FLS,18.360 FLLS,18.360 FLLS/N	04/2000 -	B 180 APC	B 180 EHD	B 185 APC	
TGA 18.360 FPLS	12/2000 -	B 180 APC	B 180 EHD	B 185 APC	
TGA 18.390 FAC	05/2004 -	B 180 APC	B 180 EHD	B 185 APC	
TGA 18.390 FAK, FAK-L, FALK, FALK-L	05/2004 -	B 180 APC	B 180 EHD	B 185 APC	
TGA 18.390 FAS, FALS	05/2004 -	B 180 APC	B 180 EHD	B 185 APC	
TGA 18.390 FC, FLC, FLLC, FLLC/N, FLLW, FLLW/N	05/2004 -	B 180 APC	B 180 EHD	B 185 APC	
TGA 18.390 FK, FLK, FLK/M	05/2004 -	B 180 APC	B 180 EHD	B 185 APC	
TGA 18.390 FLS, FLS-TS, FLS/M, FLLS, FLLS/N, FLLS/M	05/2004 -	B 180 APC	B 180 EHD	B 185 APC	
TGA 18.400 FLS, FLLS, FLRS, FLLRS	10/2005 -	B 180 APC	B 180 EHD	B 185 APC	
TGA 18.410 FAC,	09/2002 -	B 180 APC	B 180 EHD	B 185 APC	
TGA 18.410 FAK, FAK-L	09/2002 -	B 180 APC	B 180 EHD	B 185 APC	
TGA 18.410 FAS	09/2002 -	B 180 APC	B 180 EHD	B 185 APC	
TGA 18.410 FK,18.410 FLK	12/2000 -	B 180 APC	B 180 EHD	B 185 APC	
TGA 18.410 FLC,18.410 FLLC	04/2000 -	B 180 APC	B 180 EHD	B 185 APC	
TGA 18.410 FLS,18.410 FLLS	04/2000 -	B 180 APC	B 180 EHD	B 185 APC	
TGA 18.430 FAC	05/2004 -	B 180 APC	B 180 EHD	B 185 APC	
TGA 18.430 FAK, FALK, FALK-L	05/2004 -	B 180 APC	B 180 EHD	B 185 APC	
TGA 18.430 FAS, FALS	05/2004 -	B 180 APC	B 180 EHD	B 185 APC	
TGA 18.430 FC, FLC, FLLC, FLLW, FLLW/N	05/2004 -	B 180 APC	B 180 EHD	B 185 APC	
TGA 18.430 FK, FK-L, FLK, FLK/M	05/2004 -	B 180 APC	B 180 EHD	B 185 APC	
TGA 18.430 FLS, FLS/M, FLS-TS, FLLS, FLLS/N	05/2004 -	B 180 APC	B 180 EHD	B 185 APC	
TGA 18.440 FLS, FLLS, FLRS, FLLRS	09/2005 -	B 180 APC	B 180 EHD	B 185 APC	
TGA 18.460 FAK	12/2000 -	B 180 APC	B 180 EHD	B 185 APC	
TGA 18.460 FK,18.460 FLK	12/2000 -	B 180 APC	B 180 EHD	B 185 APC	
TGA 18.460 FLC,18.460 FLLC	04/2000 -	B 180 APC	B 180 EHD	B 185 APC	
TGA 18.460 FLS,18.460 FLLS	04/2000 -	B 180 APC	B 180 EHD	B 185 APC	
TGA 18.480 FAC	02/2006 -	B 180 APC	B 180 EHD	B 185 APC	

MARCHIO E MODELLO - MAKE AND MODEL MARQUE ET MODÈLE - MARKE UND MODELL MARCA Y MODELO - МАРКА И МОДЕЛЬ	Periodo Period	powerCUBE		energyCUBE	
		APC	EHD	APC	RST
MAN					
<i>cont.</i>					
TGA 18.480 FAC	09/2002 -	B 180 APC	B 180 EHD	B 185 APC	
TGA 18.480 FAK	09/2002 -	B 180 APC	B 180 EHD	B 185 APC	
TGA 18.480 FAK, FALK	02/2006 -	B 180 APC	B 180 EHD	B 185 APC	
TGA 18.480 FAS	09/2002 -	B 180 APC	B 180 EHD	B 185 APC	
TGA 18.480 FAS, FALS	02/2006 -	B 180 APC	B 180 EHD	B 185 APC	
TGA 18.480 FC	01/2006 -	B 180 APC	B 180 EHD	B 185 APC	
TGA 18.480 FC, 18.480 FLC,	09/2002 -	B 180 APC	B 180 EHD	B 185 APC	
TGA 18.480 FHLC	04/2006 -	B 180 APC	B 180 EHD	B 185 APC	
TGA 18.480 FHLK, FHLK/M	04/2006 -	B 180 APC	B 180 EHD	B 185 APC	
TGA 18.480 FHLS, FHLS/M	04/2006 -	B 180 APC	B 180 EHD	B 185 APC	
TGA 18.480 FK, 18.480 FLK	09/2002 -	B 180 APC	B 180 EHD	B 185 APC	
TGA 18.480 FK, FK-L	01/2006 -	B 180 APC	B 180 EHD	B 185 APC	
TGA 18.480 FLS, FLLS, FLRS, FLLRS	01/2006 -	B 180 APC	B 180 EHD	B 185 APC	
TGA 18.480 FS	09/2002 -	B 180 APC	B 180 EHD	B 185 APC	
TGA 18.510 FC, 18.510 FLC, 18.510 FLLC, 18.510 FLLW	09/2000 -	B 180 APC	B 180 EHD	B 185 APC	
TGA 18.510 FLS, 18.510 FLLS, 18.510 FLLS/N	04/2000 -	B 180 APC	B 180 EHD	B 185 APC	
TGA 18.530 FAC	04/2004 -	B 180 APC	B 180 EHD	B 185 APC	
TGA 18.530 FAK, FALK	04/2004 -	B 180 APC	B 180 EHD	B 185 APC	
TGA 18.530 FAS, FALS	04/2004 -	B 180 APC	B 180 EHD	B 185 APC	
TGA 18.530 FLS	09/2002 -	B 180 APC	B 180 EHD	B 185 APC	
TGA 18.533 FC, FLC, FLLC, FLLC/N, FLLW	09/2002 -	B 180 APC	B 180 EHD	B 185 APC	
TGA 18.540 FLC, FLLC, FLLRC	08/2006 -	B 180 APC	B 180 EHD	B 185 APC	
TGA 18.540 FLS, FLLS, FLLRS	08/2006 -	B 180 APC	B 180 EHD	B 185 APC	
TGA 19.350 FS, FRS, FLS, FLRS-WW	05/2004 -	B 180 APC	B 180 EHD	B 185 APC	
TGA 19.360 FS, FRS, FLS, FLRS-WW	05/2004 -	B 180 APC	B 180 EHD	B 185 APC	
TGA 19.360 FS/M-WW, FRS/M-WW	05/2004 -	B 180 APC	B 180 EHD	B 185 APC	
TGA 19.390 FS, FRS, FLS, FLRS-WW	05/2004 -	B 180 APC	B 180 EHD	B 185 APC	
TGA 19.400 FS/M-WW, FRS/M-WW, FLS, FLRS	05/2004 -	B 180 APC	B 180 EHD	B 185 APC	
TGA 19.410 FS/M-WW, FRS/M-WW	05/2004 -	B 180 APC	B 180 EHD	B 185 APC	
TGA 19.430 FS/M-WW, FLS, FLRS	05/2004 -	B 180 APC	B 180 EHD	B 185 APC	
TGA 19.440 FRS, FS/M-WW, FLS, FLRS	02/2006 -	B 180 APC	B 180 EHD	B 185 APC	
TGA 19.460 FS/M-WW, FRS/M-WW	05/2004 -	B 180 APC	B 180 EHD	B 185 APC	
TGA 19.480 FLS, FLRS-WW	02/2006 -	B 180 APC	B 180 EHD	B 185 APC	
TGA 19.480 FS/M, FRS/M-WW	02/2006 -	B 180 APC	B 180 EHD	B 185 APC	
TGA 19.480 FS/M-WW, FRS/M-WW	05/2004 -	B 180 APC	B 180 EHD	B 185 APC	
TGA 24.350, 24.360 FNLLC, FNLLW/N	05/2004 -	B 180 APC	B 180 EHD	B 185 APC	
TGA 24.350, 24.360 FPLS, FPLRS	02/2004 -	B 180 APC	B 180 EHD	B 185 APC	
TGA 24.360 FNLLC/N	09/2001 -	B 180 APC	B 180 EHD	B 185 APC	
TGA 24.390, 24.400 FNLLC/N, FNLLW/N	05/2004 -	B 180 APC	B 180 EHD	B 185 APC	
TGA 24.390, 24.400 FPLS, FPLRS	05/2004 -	B 180 APC	B 180 EHD	B 185 APC	
TGA 24.410 FNLLC/N	09/2001 -	B 180 APC	B 180 EHD	B 185 APC	
TGA 24.430, 24.440 FNLLC/N, FNLR	05/2004 -	B 180 APC	B 180 EHD	B 185 APC	
TGA 24.430, 24.440 FPLS, FPLRS	05/2004 -	B 180 APC	B 180 EHD	B 185 APC	
TGA 24.460 FNLLC/N	09/2001 -	B 180 APC	B 180 EHD	B 185 APC	
TGA 24.480 FNLLC/N, FNLLW/N	01/2006 -	B 180 APC	B 180 EHD	B 185 APC	

MARCHIO E MODELLO - MAKE AND MODEL MARQUE ET MODÈLE - MARKE UND MODELL MARCA Y MODELO - МАРКА И МОДЕЛЬ	Periodo Period	powerCUBE		energyCUBE	
		APC	EHD	APC	RST
MAN					
<i>cont.</i>					
TGA 24.480 FNNL/N	09/2002 -	B 180 APC	B 180 EHD	B 185 APC	
TGA 24.480 FPLS, FPLRS	01/2006 -	B 180 APC	B 180 EHD	B 185 APC	
TGA 24.480 FPLS, FPLRS	07/2005 -	B 180 APC	B 180 EHD	B 185 APC	
TGA 24.510 FNLLC/N	09/2001 -	B 180 APC	B 180 EHD	B 185 APC	
TGA 24.530 FNLLC/N	09/2001 -	B 180 APC	B 180 EHD	B 185 APC	
TGA 24.530 FPLS, FPLRS	07/2005 -	B 180 APC	B 180 EHD	B 185 APC	
TGA 24.540 FNLLC/N, FLLCW/N	01/2006 -	B 180 APC	B 180 EHD	B 185 APC	
TGA 26	12/2000 -	B 180 APC	B 180 EHD	B 185 APC	
TGA 26.280 FNLC, FNLLC, FNLLW	11/2002 -	B 180 APC	B 180 EHD	B 185 APC	
TGA 26.310 FDAC	01/2004 -	B 180 APC	B 180 EHD	B 185 APC	
TGA 26.310 FDAC	02/2002 -	B 180 APC	B 180 EHD	B 185 APC	
TGA 26.310 FDAK	01/2004 -	B 180 APC	B 180 EHD	B 185 APC	
TGA 26.310 FDAK	02/2002 -	B 180 APC	B 180 EHD	B 185 APC	
TGA 26.310 FDAS	01/2004 -	B 180 APC	B 180 EHD	B 185 APC	
TGA 26.310 FDAS	02/2002 -	B 180 APC	B 180 EHD	B 185 APC	
TGA 26.310 FDC	01/2001 -	B 180 APC	B 180 EHD	B 185 APC	
TGA 26.310 FDK, FDLK	09/2002 -	B 180 APC	B 180 EHD	B 185 APC	
TGA 26.310 FDLS	01/2001 -	B 180 APC	B 180 EHD	B 185 APC	
TGA 26.310 FD-TM	10/2000 -	B 180 APC	B 180 EHD	B 185 APC	
TGA 26.310 FNLC,26.310 FNLLC	09/2000 -	B 180 APC	B 180 EHD	B 185 APC	
TGA 26.310 FVLC	09/2003 -	B 180 APC	B 180 EHD	B 185 APC	
TGA 26.310 FVL-KO	12/2000 -	B 180 APC	B 180 EHD	B 185 APC	
TGA 26.310 FVLS	12/2000 -	B 180 APC	B 180 EHD	B 185 APC	
TGA 26.310 FVLS,26.310 FPLS	12/2000 -	B 180 APC	B 180 EHD	B 185 APC	
TGA 26.310, 26.310 FVL-KO	02/2004 -	B 180 APC	B 180 EHD	B 185 APC	
TGA 26.310, 26.320 FDC, FDRC, FDC/M, FDRC/M	05/2004 -	B 180 APC	B 180 EHD	B 185 APC	
TGA 26.310, 26.320 FDHC, FDHC/M	06/2005 -	B 180 APC	B 180 EHD	B 185 APC	
TGA 26.310, 26.320 FDHK	06/2005 -	B 180 APC	B 180 EHD	B 185 APC	
TGA 26.310, 26.320 FDHS, FDHS/M	06/2005 -	B 180 APC	B 180 EHD	B 185 APC	
TGA 26.310, 26.320 FDH-TM	06/2005 -	B 180 APC	B 180 EHD	B 185 APC	
TGA 26.310, 26.320 FDK, FDLK	05/2004 -	B 180 APC	B 180 EHD	B 185 APC	
TGA 26.310, 26.320 FDS, FDLS, FNHLS	05/2004 -	B 180 APC	B 180 EHD	B 185 APC	
TGA 26.310, 26.320 FD-TM	06/2005 -	B 180 APC	B 180 EHD	B 185 APC	
TGA 26.310, 26.320 FNLC, FNLLC, FNLR, FNLLRC	05/2004 -	B 180 APC	B 180 EHD	B 185 APC	
TGA 26.310, 26.320 FNLS, FNLLS, FNLR, FNLLRS	05/2004 -	B 180 APC	B 180 EHD	B 185 APC	
TGA 26.310, 26.320 FVHL-KO	06/2005 -	B 180 APC	B 180 EHD	B 185 APC	
TGA 26.310, 26.320 FVLC	02/2004 -	B 180 APC	B 180 EHD	B 185 APC	
TGA 26.320 FDAC	04/2006 -	B 180 APC	B 180 EHD	B 185 APC	
TGA 26.320 FDAK	04/2006 -	B 180 APC	B 180 EHD	B 185 APC	
TGA 26.320 FDAS	04/2006 -	B 180 APC	B 180 EHD	B 185 APC	
TGA 26.330 FNLC, FNLLC, FNLLW	11/2002 -	B 180 APC	B 180 EHD	B 185 APC	
TGA 26.350 FDAC	02/2004 -	B 180 APC	B 180 EHD	B 185 APC	
TGA 26.350 FDAK	02/2004 -	B 180 APC	B 180 EHD	B 185 APC	
TGA 26.350 FDAS	02/2004 -	B 180 APC	B 180 EHD	B 185 APC	
TGA 26.350 FDHC, FDHC/M	04/2005 -	B 180 APC	B 180 EHD	B 185 APC	

MARCHIO E MODELLO - MAKE AND MODEL MARQUE ET MODÈLE - MARKE UND MODELL MARCA Y MODELO - МАРКА И МОДЕЛЬ	Periodo Period	powerCUBE		energyCUBE	
		APC	EHD	APC	RST
MAN cont.					
TGA 26.350 FDLRC-WW	05/2004 -	B 180 APC	B 180 EHD	B 185 APC	
TGA 26.350 FDLRS, FDLRS/M, FDLRS-WW	05/2004 -	B 180 APC	B 180 EHD	B 185 APC	
TGA 26.350 FVHLC	06/2005 -	B 180 APC	B 180 EHD	B 185 APC	
TGA 26.350 FVHLS	07/2005 -	B 180 APC	B 180 EHD	B 185 APC	
TGA 26.350 FVLC	01/2004 -	B 180 APC	B 180 EHD	B 185 APC	
TGA 26.350 FVLS, FVLRS	07/2005 -	B 180 APC	B 180 EHD	B 185 APC	
TGA 26.350, 26.360 FDC, FDRC, FDC/M, FDRC/M	05/2004 -	B 180 APC	B 180 EHD	B 185 APC	
TGA 26.350, 26.360 FDHK	05/2004 -	B 180 APC	B 180 EHD	B 185 APC	
TGA 26.350, 26.360 FDHS, FDHS/M	05/2004 -	B 180 APC	B 180 EHD	B 185 APC	
TGA 26.350, 26.360 FDH-TM	05/2004 -	B 180 APC	B 180 EHD	B 185 APC	
TGA 26.350, 26.360 FDK, FDLK	05/2004 -	B 180 APC	B 180 EHD	B 185 APC	
TGA 26.350, 26.360 FDS, FDLS, FNHLS	05/2004 -	B 180 APC	B 180 EHD	B 185 APC	
TGA 26.350, 26.360 FD-TM	02/2004 -	B 180 APC	B 180 EHD	B 185 APC	
TGA 26.350, 26.360 FNLC, FNLLC, FNLLW, FNLRC, FNLLRC	05/2004 -	B 180 APC	B 180 EHD	B 185 APC	
TGA 26.350, 26.360 FNLS, FNLLS, FNLRS, FNLLRS	05/2004 -	B 180 APC	B 180 EHD	B 185 APC	
TGA 26.350, 26.360 FVHL-KO	06/2005 -	B 180 APC	B 180 EHD	B 185 APC	
TGA 26.350, 26.360 FVL-KO	06/2005 -	B 180 APC	B 180 EHD	B 185 APC	
TGA 26.360 FDAC	02/2002 -	B 180 APC	B 180 EHD	B 185 APC	
TGA 26.360 FDAC, FDARC	06/2004 -	B 180 APC	B 180 EHD	B 185 APC	
TGA 26.360 FDAK	02/2002 -	B 180 APC	B 180 EHD	B 185 APC	
TGA 26.360 FDAK, FDARK	06/2004 -	B 180 APC	B 180 EHD	B 185 APC	
TGA 26.360 FDAS, FDARS	06/2004 -	B 180 APC	B 180 EHD	B 185 APC	
TGA 26.360 FDC	01/2001 -	B 180 APC	B 180 EHD	B 185 APC	
TGA 26.360 FDHC, FDHLC	05/2004 -	B 180 APC	B 180 EHD	B 185 APC	
TGA 26.360 FDK	02/2002 -	B 180 APC	B 180 EHD	B 185 APC	
TGA 26.360 FDK, FDLK	09/2002 -	B 180 APC	B 180 EHD	B 185 APC	
TGA 26.360 FDLC-WW, FDLRC	05/2004 -	B 180 APC	B 180 EHD	B 185 APC	
TGA 26.360 FDLS, FDLRS-WW	05/2004 -	B 180 APC	B 180 EHD	B 185 APC	
TGA 26.360 FDLS, FDLS/M, FDLRS, FDLRS/M	09/2003 -	B 180 APC	B 180 EHD	B 185 APC	
TGA 26.360 FD-TM	01/2001 -	B 180 APC	B 180 EHD	B 185 APC	
TGA 26.360 FNLC, 26.360 FNLLC, 26.360 FNLLW	09/2000 -	B 180 APC	B 180 EHD	B 185 APC	
TGA 26.360 FVHLC	04/2006 -	B 180 APC	B 180 EHD	B 185 APC	
TGA 26.360 FVHLS	04/2006 -	B 180 APC	B 180 EHD	B 185 APC	
TGA 26.360 FVLC	04/2006 -	B 180 APC	B 180 EHD	B 185 APC	
TGA 26.360 FVL-KO	12/2000 -	B 180 APC	B 180 EHD	B 185 APC	
TGA 26.360 FVLS, FVLRS	04/2006 -	B 180 APC	B 180 EHD	B 185 APC	
TGA 26.390 FDAC, FDALC	01/2004 -	B 180 APC	B 180 EHD	B 185 APC	
TGA 26.390 FDAK, FDALK	02/2004 -	B 180 APC	B 180 EHD	B 185 APC	
TGA 26.390 FDAS, FDALS	02/2004 -	B 180 APC	B 180 EHD	B 185 APC	
TGA 26.390 FDH-TM	06/2005 -	B 180 APC	B 180 EHD	B 185 APC	
TGA 26.390 FVHL-KO	06/2005 -	B 180 APC	B 180 EHD	B 185 APC	
TGA 26.390 FVLC	02/2004 -	B 180 APC	B 180 EHD	B 185 APC	
TGA 26.390 FVLS, FVLRS	07/2005 -	B 180 APC	B 180 EHD	B 185 APC	
TGA 26.390, 26.400 FDC, FDRC, FDC/M, FDRC/M	05/2004 -	B 180 APC	B 180 EHD	B 185 APC	
TGA 26.390, 26.400 FDHC, FDHC/M	06/2005 -	B 180 APC	B 180 EHD	B 185 APC	

MARCHIO E MODELLO - <i>MAKE AND MODEL</i> MARQUE ET MODÈLE - <i>MARKE UND MODELL</i> MARCA Y MODELO - <i>МАРКА И МОДЕЛЬ</i>	Periodo <i>Period</i>	powerCUBE		energyCUBE	
		APC	EHD	APC	RST
MAN <small>cont.</small>					
TGA 26.390, 26.400 FDHK	06/2005 -	B 180 APC	B 180 EHD	B 185 APC	
TGA 26.390, 26.400 FDHS, FDHS/M	06/2005 -	B 180 APC	B 180 EHD	B 185 APC	
TGA 26.390, 26.400 FDK, FDLK	05/2004 -	B 180 APC	B 180 EHD	B 185 APC	
TGA 26.390, 26.400 FDS, FDLS, FNHLS	05/2004 -	B 180 APC	B 180 EHD	B 185 APC	
TGA 26.390, 26.400 FD-TM	05/2004 -	B 180 APC	B 180 EHD	B 185 APC	
TGA 26.390, 26.400 FNLC, FNLLC, FNLLW, FNLRC, FNLLRC	05/2004 -	B 180 APC	B 180 EHD	B 185 APC	
TGA 26.390, 26.400 FNLS, FNLLS, FNLRS, FNLLRS	05/2004 -	B 180 APC	B 180 EHD	B 185 APC	
TGA 26.390, 26.400 FVL-KO	02/2004 -	B 180 APC	B 180 EHD	B 185 APC	
TGA 26.400 FDAC, FDALC	01/2004 -	B 180 APC	B 180 EHD	B 185 APC	
TGA 26.400 FDAK, FDALK	01/2004 -	B 180 APC	B 180 EHD	B 185 APC	
TGA 26.400 FDAS, FDALS	01/2004 -	B 180 APC	B 180 EHD	B 185 APC	
TGA 26.400 FDH-TM	04/2006 -	B 180 APC	B 180 EHD	B 185 APC	
TGA 26.400 FVLC	04/2006 -	B 180 APC	B 180 EHD	B 185 APC	
TGA 26.400 FVLS, FVLRS	04/2006 -	B 180 APC	B 180 EHD	B 185 APC	
TGA 26.410 FDAC	02/2002 -	B 180 APC	B 180 EHD	B 185 APC	
TGA 26.410 FDAK	02/2002 -	B 180 APC	B 180 EHD	B 185 APC	
TGA 26.410 FDAS	02/2002 -	B 180 APC	B 180 EHD	B 185 APC	
TGA 26.410 FDC	01/2001 -	B 180 APC	B 180 EHD	B 185 APC	
TGA 26.410 FDK	09/2001 -	B 180 APC	B 180 EHD	B 185 APC	
TGA 26.410 FDS, FDLS	06/2001 -	B 180 APC	B 180 EHD	B 185 APC	
TGA 26.410 FD-TM	01/2001 -	B 180 APC	B 180 EHD	B 185 APC	
TGA 26.410 FNLC, 26.410 FNLLC, 26.410 FNLLW	04/2000 -	B 180 APC	B 180 EHD	B 185 APC	
TGA 26.410 FVLC	09/2003 -	B 180 APC	B 180 EHD	B 185 APC	
TGA 26.410 FVL-KO	12/2000 -	B 180 APC	B 180 EHD	B 185 APC	
TGA 26.410 FVLS, FVLRS	07/2005 -	B 180 APC	B 180 EHD	B 185 APC	
TGA 26.413 FPLS	12/2000 -	B 180 APC	B 180 EHD	B 185 APC	
TGA 26.430 FDAC, FDALC	01/2004 -	B 180 APC	B 180 EHD	B 185 APC	
TGA 26.430 FDAK, FDALK	01/2004 -	B 180 APC	B 180 EHD	B 185 APC	
TGA 26.430 FDAS, FDALS	01/2004 -	B 180 APC	B 180 EHD	B 185 APC	
TGA 26.430 FDK-WW	06/2005 -	B 180 APC	B 180 EHD	B 185 APC	
TGA 26.430 FDLS, FDLS/M, FDLRS-WW	02/2004 -	B 180 APC	B 180 EHD	B 185 APC	
TGA 26.430 FVL-KO	12/2000 -	B 180 APC	B 180 EHD	B 185 APC	
TGA 26.430 FVLS, FVLRS	07/2005 -	B 180 APC	B 180 EHD	B 185 APC	
TGA 26.430, 26.440 FDC, FDRC, FDC/M, FDRC/M	05/2004 -	B 180 APC	B 180 EHD	B 185 APC	
TGA 26.430, 26.440 FDHC, FDHC/M	06/2005 -	B 180 APC	B 180 EHD	B 185 APC	
TGA 26.430, 26.440 FDHK	06/2005 -	B 180 APC	B 180 EHD	B 185 APC	
TGA 26.430, 26.440 FDHS, FDHS/M	06/2005 -	B 180 APC	B 180 EHD	B 185 APC	
TGA 26.430, 26.440 FDH-TM	06/2005 -	B 180 APC	B 180 EHD	B 185 APC	
TGA 26.430, 26.440 FDK, FDLK	05/2004 -	B 180 APC	B 180 EHD	B 185 APC	
TGA 26.430, 26.440 FDS, FDS/M, FDRS, FDRS/M, FPHLS, FVHLS	02/2004 -	B 180 APC	B 180 EHD	B 185 APC	
TGA 26.430, 26.440 FD-TM	05/2004 -	B 180 APC	B 180 EHD	B 185 APC	
TGA 26.430, 26.440 FVLH-KO	06/2005 -	B 180 APC	B 180 EHD	B 185 APC	
TGA 26.430, 26.440 FNLC, FNLLC, FNLLW, FNLRC, FNLLRC	05/2004 -	B 180 APC	B 180 EHD	B 185 APC	
TGA 26.430, 26.440 FNLS, FNLLS, FNLRS, FNLLRS	05/2004 -	B 180 APC	B 180 EHD	B 185 APC	
TGA 26.440 FDAC, FDALC	09/2005 -	B 180 APC	B 180 EHD	B 185 APC	

MARCHIO E MODELLO - MAKE AND MODEL MARQUE ET MODÈLE - MARKE UND MODELL MARCA Y MODELO - МАРКА И МОДЕЛЬ	Periodo Period	powerCUBE		energyCUBE	
		APC	EHD	APC	RST
MAN cont.					
TGA 26.440 FDAK, FDALK	01/2004 -	B 180 APC	B 180 EHD	B 185 APC	
TGA 26.440 FDAS, FDALS	01/2004 -	B 180 APC	B 180 EHD	B 185 APC	
TGA 26.440 FDLC-WW, FDLRC-WW	02/2006 -	B 180 APC	B 180 EHD	B 185 APC	
TGA 26.440 FDLS-WW, FDLRS-WW	02/2006 -	B 180 APC	B 180 EHD	B 185 APC	
TGA 26.440 FVL-KO	09/2005 -	B 180 APC	B 180 EHD	B 185 APC	
TGA 26.440 FVLS, FVLSRS	09/2005 -	B 180 APC	B 180 EHD	B 185 APC	
TGA 26.460 FDAC	09/2002 -	B 180 APC	B 180 EHD	B 185 APC	
TGA 26.460 FDAS	09/2002 -	B 180 APC	B 180 EHD	B 185 APC	
TGA 26.460 FDC	01/2001 -	B 180 APC	B 180 EHD	B 185 APC	
TGA 26.460 FDK	01/2001 -	B 180 APC	B 180 EHD	B 185 APC	
TGA 26.460 FDS, FDLS	06/2001 -	B 180 APC	B 180 EHD	B 185 APC	
TGA 26.460 FD-TM	01/2001 -	B 180 APC	B 180 EHD	B 185 APC	
TGA 26.460 FNLC,26.460 FNLLC,26.460 FNLLW	04/2000 -	B 180 APC	B 180 EHD	B 185 APC	
TGA 26.460 FPLS	12/2000 -	B 180 APC	B 180 EHD	B 185 APC	
TGA 26.460 FVLC	02/2001 -	B 180 APC	B 180 EHD	B 185 APC	
TGA 26.460 FVL-KO	12/2000 -	B 180 APC	B 180 EHD	B 185 APC	
TGA 26.480 FDAC, FDALC	02/2006 -	B 180 APC	B 180 EHD	B 185 APC	
TGA 26.480 FDAK	09/2002 -	B 180 APC	B 180 EHD	B 185 APC	
TGA 26.480 FDAK, FDALK	02/2006 -	B 180 APC	B 180 EHD	B 185 APC	
TGA 26.480 FDAS, FDALS	02/2006 -	B 180 APC	B 180 EHD	B 185 APC	
TGA 26.480 FDC, FDLC	09/2002 -	B 180 APC	B 180 EHD	B 185 APC	
TGA 26.480 FDC, FDLC, FNHLC	02/2006 -	B 180 APC	B 180 EHD	B 185 APC	
TGA 26.480 FDHC, FDHC/M	02/2006 -	B 180 APC	B 180 EHD	B 185 APC	
TGA 26.480 FDHK	02/2006 -	B 180 APC	B 180 EHD	B 185 APC	
TGA 26.480 FDHS, FDHS/M	02/2006 -	B 180 APC	B 180 EHD	B 185 APC	
TGA 26.480 FDH-TM	02/2006 -	B 180 APC	B 180 EHD	B 185 APC	
TGA 26.480 FDK, FDLK	02/2006 -	B 180 APC	B 180 EHD	B 185 APC	
TGA 26.480 FDK, FDLK	09/2002 -	B 180 APC	B 180 EHD	B 185 APC	
TGA 26.480 FDS, FDLS, FDLS/M	09/2002 -	B 180 APC	B 180 EHD	B 185 APC	
TGA 26.480 FDS, FDLS, FNHLC	02/2006 -	B 180 APC	B 180 EHD	B 185 APC	
TGA 26.480 FD-TM	02/2006 -	B 180 APC	B 180 EHD	B 185 APC	
TGA 26.480 FD-TM	09/2002 -	B 180 APC	B 180 EHD	B 185 APC	
TGA 26.480 FNLC, FNLLC, FVLC	09/2002 -	B 180 APC	B 180 EHD	B 185 APC	
TGA 26.480 FNLC, FNLC	02/2006 -	B 180 APC	B 180 EHD	B 185 APC	
TGA 26.480 FNLS, FNLLS, FPLS, FVLS	09/2002 -	B 180 APC	B 180 EHD	B 185 APC	
TGA 26.480 FNLS, FNLSRS	02/2006 -	B 180 APC	B 180 EHD	B 185 APC	
TGA 26.480 FVHL-KO	02/2006 -	B 180 APC	B 180 EHD	B 185 APC	
TGA 26.480 FVLC	09/2002 -	B 180 APC	B 180 EHD	B 185 APC	
TGA 26.480 FVL-KO	01/2006 -	B 180 APC	B 180 EHD	B 185 APC	
TGA 26.510 FDC, FDLC, FDC/M	01/2001 -	B 180 APC	B 180 EHD	B 185 APC	
TGA 26.510 FDS, FDLS, FDLS/M	01/2001 -	B 180 APC	B 180 EHD	B 185 APC	
TGA 26.510 FLC	09/2002 -	B 180 APC	B 180 EHD	B 185 APC	
TGA 26.510 FNLC,26.510 FNLLW	12/2000 -	B 180 APC	B 180 EHD	B 185 APC	
TGA 26.530 FDAK, FDALK	09/2002 -	B 180 APC	B 180 EHD	B 185 APC	
TGA 26.530 FDALC	07/2006 -	B 180 APC	B 180 EHD	B 185 APC	

MARCHIO E MODELLO - MAKE AND MODEL MARQUE ET MODÈLE - MARKE UND MODELL MARCA Y MODELO - МАРКА И МОДЕЛЬ	Periodo Period	powerCUBE		energyCUBE	
		APC	EHD	APC	RST
MAN					
<i>cont.</i>					
TGA 26.530 FDALS	07/2006 -	B 180 APC	B 180 EHD	B 185 APC	
TGA 26.530 FDC, FDLC, FDC/M,	01/2001 -	B 180 APC	B 180 EHD	B 185 APC	
TGA 26.530 FDK, FDKL	09/2002 -	B 180 APC	B 180 EHD	B 185 APC	
TGA 26.530 FDS, FDLS, FDLS/M	01/2001 -	B 180 APC	B 180 EHD	B 185 APC	
TGA 26.530 FNLS, FPLS, FVLS,	09/2002 -	B 180 APC	B 180 EHD	B 185 APC	
TGA 26.540 FNLC, FNLLC, FNLLRC, FNLLW	08/2006 -	B 180 APC	B 180 EHD	B 185 APC	
TGA 27.440 FDS, FDLS, FDRS, FDLRS	10/2008 -	B 180 APC	B 180 EHD	B 185 APC	
TGA 28.310 FNLC	09/2002 -	B 180 APC	B 180 EHD	B 185 APC	
TGA 28.310 FNLC, FNLLC	09/2002 -	B 180 APC	B 180 EHD	B 185 APC	
TGA 28.310 FNLC, FNLLC, FNLR	09/2002 -	B 180 APC	B 180 EHD	B 185 APC	
TGA 28.310 FNLS	09/2002 -	B 180 APC	B 180 EHD	B 185 APC	
TGA 28.310 FNLS, FNLR	06/2004 -	B 180 APC	B 180 EHD	B 185 APC	
TGA 28.310, 28.320 FNLC, FNLLC	07/2006 -	B 180 APC	B 180 EHD	B 185 APC	
TGA 28.310, 28.320 FNLC, FNLLC, FNLL-LE	07/2006 -	B 180 APC	B 180 EHD	B 185 APC	
TGA 28.320 FNLC, FNLLC, FNLR	06/2004 -	B 180 APC	B 180 EHD	B 185 APC	
TGA 28.320 FNLS, FNLR	06/2004 -	B 180 APC	B 180 EHD	B 185 APC	
TGA 28.350 FANLC	07/2006 -	B 180 APC	B 180 EHD	B 185 APC	
TGA 28.350 FANLK	07/2006 -	B 180 APC	B 180 EHD	B 185 APC	
TGA 28.350 FNLS, FNLR-WW	02/2004 -	B 180 APC	B 180 EHD	B 185 APC	
TGA 28.350, 28.360 FNLC, FNLLC	06/2004 -	B 180 APC	B 180 EHD	B 185 APC	
TGA 28.350, 28.360 FNLC, FNLLC, FNLL-LE	07/2006 -	B 180 APC	B 180 EHD	B 185 APC	
TGA 28.360 FANLC	07/2006 -	B 180 APC	B 180 EHD	B 185 APC	
TGA 28.360 FANLK	07/2006 -	B 180 APC	B 180 EHD	B 185 APC	
TGA 28.360 FNLC	09/2002 -	B 180 APC	B 180 EHD	B 185 APC	
TGA 28.360 FNLC, FNLLC	09/2002 -	B 180 APC	B 180 EHD	B 185 APC	
TGA 28.360 FNLS	09/2002 -	B 180 APC	B 180 EHD	B 185 APC	
TGA 28.360 FNLS, FNLR-WW	04/2006 -	B 180 APC	B 180 EHD	B 185 APC	
TGA 28.390 FANLC	07/2006 -	B 180 APC	B 180 EHD	B 185 APC	
TGA 28.390 FANLK	07/2006 -	B 180 APC	B 180 EHD	B 185 APC	
TGA 28.390 FNLLC	07/2006 -	B 180 APC	B 180 EHD	B 185 APC	
TGA 28.390 FNLS-WW, FNLR	05/2004 -	B 180 APC	B 180 EHD	B 185 APC	
TGA 28.390, 28.400 FNLC, FNLLC	06/2004 -	B 180 APC	B 180 EHD	B 185 APC	
TGA 28.400 FANLC	07/2006 -	B 180 APC	B 180 EHD	B 185 APC	
TGA 28.400 FANLK	07/2006 -	B 180 APC	B 180 EHD	B 185 APC	
TGA 28.400 FNLS, FNLR	04/2006 -	B 180 APC	B 180 EHD	B 185 APC	
TGA 28.410 FANLC	07/2006 -	B 180 APC	B 180 EHD	B 185 APC	
TGA 28.410 FANLK	07/2006 -	B 180 APC	B 180 EHD	B 185 APC	
TGA 28.410 FNLC	09/2002 -	B 180 APC	B 180 EHD	B 185 APC	
TGA 28.410 FNLC, FNLLC	09/2002 -	B 180 APC	B 180 EHD	B 185 APC	
TGA 28.410 FNLS	09/2002 -	B 180 APC	B 180 EHD	B 185 APC	
TGA 28.430 FANLC	07/2006 -	B 180 APC	B 180 EHD	B 185 APC	
TGA 28.430 FANLK	07/2006 -	B 180 APC	B 180 EHD	B 185 APC	
TGA 28.430 FNLS, FNLR-WW	05/2004 -	B 180 APC	B 180 EHD	B 185 APC	
TGA 28.430, 28.440 FNLC, FNLLC	06/2004 -	B 180 APC	B 180 EHD	B 185 APC	
TGA 28.440 FANLC	07/2006 -	B 180 APC	B 180 EHD	B 185 APC	

MARCHIO E MODELLO - MAKE AND MODEL MARQUE ET MODÈLE - MARKE UND MODELL MARCA Y MODELO - МАРКА И МОДЕЛЬ	Periodo Period	powerCUBE		energyCUBE	
		APC	EHD	APC	RST
MAN <small>cont.</small>					
TGA 28.440 FANLK	07/2006 -	B 180 APC	B 180 EHD	B 185 APC	
TGA 28.440 FNLS, FNLSR-WW	09/2005 -	B 180 APC	B 180 EHD	B 185 APC	
TGA 28.460 FNLC	09/2002 -	B 180 APC	B 180 EHD	B 185 APC	
TGA 28.460 FNLS	09/2002 -	B 180 APC	B 180 EHD	B 185 APC	
TGA 28.480 FANLC	07/2006 -	B 180 APC	B 180 EHD	B 185 APC	
TGA 28.480 FANLK	07/2006 -	B 180 APC	B 180 EHD	B 185 APC	
TGA 28.480 FNLC	09/2002 -	B 180 APC	B 180 EHD	B 185 APC	
TGA 28.480 FNLC, FNLCR-WW	02/2006 -	B 180 APC	B 180 EHD	B 185 APC	
TGA 28.480 FNLS	09/2002 -	B 180 APC	B 180 EHD	B 185 APC	
TGA 28.480 FNLS, FNLSR-WW	02/2006 -	B 180 APC	B 180 EHD	B 185 APC	
TGA 28.510 FNLC	09/2002 -	B 180 APC	B 180 EHD	B 185 APC	
TGA 28.510 FNLS	09/2002 -	B 180 APC	B 180 EHD	B 185 APC	
TGA 28.530 FANLC	07/2006 -	B 180 APC	B 180 EHD	B 185 APC	
TGA 28.530 FANLK	07/2006 -	B 180 APC	B 180 EHD	B 185 APC	
TGA 28.530 FNLC	09/2002 -	B 180 APC	B 180 EHD	B 185 APC	
TGA 28.530 FNLS	09/2002 -	B 180 APC	B 180 EHD	B 185 APC	
TGA 28.540 FNLC, FNLLC	08/2006 -	B 180 APC	B 180 EHD	B 185 APC	
TGA 28.540 FNLS	08/2006 -	B 180 APC	B 180 EHD	B 185 APC	
TGA 32.310	01/2002 -	B 180 APC	B 180 EHD	B 185 APC	
TGA 32.310 FFDC, FFDLC	01/2002 -	B 180 APC	B 180 EHD	B 185 APC	
TGA 32.310 FFDK, FFDLK	01/2002 -	B 180 APC	B 180 EHD	B 185 APC	
TGA 32.350, 32.360 FFDRC	05/2004 -	B 180 APC	B 180 EHD	B 185 APC	
TGA 32.350, 32.360 FFD-TM, FFDR-TM	02/2004 -	B 180 APC	B 180 EHD	B 185 APC	
TGA 32.360 FFDC, FFDLC	01/2002 -	B 180 APC	B 180 EHD	B 185 APC	
TGA 32.360 FFDK, FFDLK	01/2002 -	B 180 APC	B 180 EHD	B 185 APC	
TGA 32.360 FFD-TM	01/2002 -	B 180 APC	B 180 EHD	B 185 APC	
TGA 32.390, 32.400 FFDRC	05/2004 -	B 180 APC	B 180 EHD	B 185 APC	
TGA 32.390, 32.400 FFD-TM, FFDR-TM	05/2004 -	B 180 APC	B 180 EHD	B 185 APC	
TGA 32.410 FFDC, FFDLC	01/2002 -	B 180 APC	B 180 EHD	B 185 APC	
TGA 32.410 FFDK, FFDLK	01/2002 -	B 180 APC	B 180 EHD	B 185 APC	
TGA 32.410 FFD-TM	01/2002 -	B 180 APC	B 180 EHD	B 185 APC	
TGA 32.430, 32.440 FFDRC	05/2004 -	B 180 APC	B 180 EHD	B 185 APC	
TGA 32.430, 32.440 FFD-TM, FFDR-TM	05/2004 -	B 180 APC	B 180 EHD	B 185 APC	
TGA 32.460 FFDC, FFDLC	01/2002 -	B 180 APC	B 180 EHD	B 185 APC	
TGA 32.460 FFDK, FFDLK	01/2002 -	B 180 APC	B 180 EHD	B 185 APC	
TGA 32.460 FFD-TM	01/2002 -	B 180 APC	B 180 EHD	B 185 APC	
TGA 32.480 FFDC, FFDLC	09/2002 -	B 180 APC	B 180 EHD	B 185 APC	
TGA 32.480 FFDK, FFDLK	09/2002 -	B 180 APC	B 180 EHD	B 185 APC	
TGA 32.480 FFDRC	02/2006 -	B 180 APC	B 180 EHD	B 185 APC	
TGA 32.480 FFD-TM	09/2002 -	B 180 APC	B 180 EHD	B 185 APC	
TGA 32.480 FFD-TM, FFDR-TM	02/2006 -	B 180 APC	B 180 EHD	B 185 APC	
TGA 33.350 FDC-TM, FDRC-TM	09/2007 -	B 180 APC	B 180 EHD	B 185 APC	
TGA 33.350, 33.360 FDC, FDC/M	05/2004 -	B 180 APC	B 180 EHD	B 185 APC	
TGA 33.350, 33.360 FDHC, FDHC/M		B 180 APC	B 180 EHD	B 185 APC	
TGA 33.350, 33.360 FDHK	06/2005 -	B 180 APC	B 180 EHD	B 185 APC	

MARCHIO E MODELLO - MAKE AND MODEL MARQUE ET MODÈLE - MARKE UND MODELL MARCA Y MODELO - МАРКА И МОДЕЛЬ	Periodo Period	powerCUBE		energyCUBE	
		APC	EHD	APC	RST
MAN					
<i>cont.</i>					
TGA 33.350, 33.360 FDHS, FDHS/M	06/2005 -	B 180 APC	B 180 EHD	B 185 APC	
TGA 33.350, 33.360 FDK	05/2004 -	B 180 APC	B 180 EHD	B 185 APC	
TGA 33.350, 33.360 FDS, FDS/M	05/2004 -	B 180 APC	B 180 EHD	B 185 APC	
TGA 33.360 FDAC	09/2002 -	B 180 APC	B 180 EHD	B 185 APC	
TGA 33.360 FDAK	09/2002 -	B 180 APC	B 180 EHD	B 185 APC	
TGA 33.360 FDAS	09/2002 -	B 180 APC	B 180 EHD	B 185 APC	
TGA 33.360 FDC	10/2000 -	B 180 APC	B 180 EHD	B 185 APC	
TGA 33.360 FDC-TM, FDRC-TM	09/2007 -	B 180 APC	B 180 EHD	B 185 APC	
TGA 33.360 FDK	01/2001 -	B 180 APC	B 180 EHD	B 185 APC	
TGA 33.360 FDS	10/2000 -	B 180 APC	B 180 EHD	B 185 APC	
TGA 33.360 FD-TM	01/2001 -	B 180 APC	B 180 EHD	B 185 APC	
TGA 33.390, 33.400 FDC, FDC/M	05/2004 -	B 180 APC	B 180 EHD	B 185 APC	
TGA 33.390, 33.400 FDC-TM, FDRC-TM	09/2007 -	B 180 APC	B 180 EHD	B 185 APC	
TGA 33.390, 33.400 FDHC, FDHC/M	06/2005 -	B 180 APC	B 180 EHD	B 185 APC	
TGA 33.390, 33.400 FDHK	06/2005 -	B 180 APC	B 180 EHD	B 185 APC	
TGA 33.390, 33.400 FDHS, FDHS/M	06/2005 -	B 180 APC	B 180 EHD	B 185 APC	
TGA 33.390, 33.400 FDK	05/2004 -	B 180 APC	B 180 EHD	B 185 APC	
TGA 33.390, 33.400 FDS, FDS/M	05/2004 -	B 180 APC	B 180 EHD	B 185 APC	
TGA 33.410 FDAC	09/2002 -	B 180 APC	B 180 EHD	B 185 APC	
TGA 33.410 FDAK	09/2002 -	B 180 APC	B 180 EHD	B 185 APC	
TGA 33.410 FDAS	09/2002 -	B 180 APC	B 180 EHD	B 185 APC	
TGA 33.410 FDC	10/2000 -	B 180 APC	B 180 EHD	B 185 APC	
TGA 33.410 FDK	10/2000 -	B 180 APC	B 180 EHD	B 185 APC	
TGA 33.410 FDS	10/2000 -	B 180 APC	B 180 EHD	B 185 APC	
TGA 33.430, 33.440 FDC, FDC/M	05/2004 -	B 180 APC	B 180 EHD	B 185 APC	
TGA 33.430, 33.440 FDHC, FDHC/M	06/2005 -	B 180 APC	B 180 EHD	B 185 APC	
TGA 33.430, 33.440 FDHK	06/2005 -	B 180 APC	B 180 EHD	B 185 APC	
TGA 33.430, 33.440 FDHS	06/2005 -	B 180 APC	B 180 EHD	B 185 APC	
TGA 33.430, 33.440 FDK	05/2004 -	B 180 APC	B 180 EHD	B 185 APC	
TGA 33.430, 33.440 FDS, FDS/M	05/2004 -	B 180 APC	B 180 EHD	B 185 APC	
TGA 33.440 FDC, FDAC	06/2005 -	B 180 APC	B 180 EHD	B 185 APC	
TGA 33.440 FDC, FDRC	06/2005 -	B 180 APC	B 180 EHD	B 185 APC	
TGA 33.440 FDC-TM, FDRC-TM	09/2007 -	B 180 APC	B 180 EHD	B 185 APC	
TGA 33.440 FDK, FDAK	06/2005 -	B 180 APC	B 180 EHD	B 185 APC	
TGA 33.440 FDK, FDRK	06/2005 -	B 180 APC	B 180 EHD	B 185 APC	
TGA 33.440 FDS, FDAS	06/2005 -	B 180 APC	B 180 EHD	B 185 APC	
TGA 33.440 FDS, FDRS	06/2005 -	B 180 APC	B 180 EHD	B 185 APC	
TGA 33.460 FDAC-WW	09/2002 -	B 180 APC	B 180 EHD	B 185 APC	
TGA 33.460 FDAK-WW	09/2002 -	B 180 APC	B 180 EHD	B 185 APC	
TGA 33.460 FDAS-WW	09/2002 -	B 180 APC	B 180 EHD	B 185 APC	
TGA 33.460 FDC	09/2002 -	B 180 APC	B 180 EHD	B 185 APC	
TGA 33.460 FDK	09/2002 -	B 180 APC	B 180 EHD	B 185 APC	
TGA 33.460 FDS	09/2002 -	B 180 APC	B 180 EHD	B 185 APC	
TGA 33.460 FD-TM	09/2002 -	B 180 APC	B 180 EHD	B 185 APC	
TGA 33.480 FDAC	09/2002 -	B 180 APC	B 180 EHD	B 185 APC	

MARCHIO E MODELLO - MAKE AND MODEL MARQUE ET MODÈLE - MARKE UND MODELL MARCA Y MODELO - МАРКА И МОДЕЛЬ	Periodo Period	powerCUBE		energyCUBE	
		APC	EHD	APC	RST
MAN					
<i>cont.</i>					
TGA 33.480 FDAK	09/2002 -	B 180 APC	B 180 EHD	B 185 APC	
TGA 33.480 FDAS	09/2002 -	B 180 APC	B 180 EHD	B 185 APC	
TGA 33.480 FDC	09/2002 -	B 180 APC	B 180 EHD	B 185 APC	
TGA 33.480 FDC, FDC/M	02/2006 -	B 180 APC	B 180 EHD	B 185 APC	
TGA 33.480 FDC-TM, FDRC-TM	09/2007 -	B 180 APC	B 180 EHD	B 185 APC	
TGA 33.480 FDHC, FDHC/M	02/2006 -	B 180 APC	B 180 EHD	B 185 APC	
TGA 33.480 FDHK	02/2006 -	B 180 APC	B 180 EHD	B 185 APC	
TGA 33.480 FDHS	02/2006 -	B 180 APC	B 180 EHD	B 185 APC	
TGA 33.480 FDK	02/2006 -	B 180 APC	B 180 EHD	B 185 APC	
TGA 33.480 FDK	09/2002 -	B 180 APC	B 180 EHD	B 185 APC	
TGA 33.480 FDS	09/2002 -	B 180 APC	B 180 EHD	B 185 APC	
TGA 33.480 FDS, FDS/M	02/2006 -	B 180 APC	B 180 EHD	B 185 APC	
TGA 33.480 FD-TM	09/2002 -	B 180 APC	B 180 EHD	B 185 APC	
TGA 33.510 FDS	09/2002 -	B 180 APC	B 180 EHD	B 185 APC	
TGA 33.530 FDALC	09/2002 -	B 180 APC	B 180 EHD	B 185 APC	
TGA 33.530 FDC, FDC/M	09/2002 -	B 180 APC	B 180 EHD	B 185 APC	
TGA 33.530 FDK	09/2002 -	B 180 APC	B 180 EHD	B 185 APC	
TGA 33.530 FDLK	07/2003 -	B 180 APC	B 180 EHD	B 185 APC	
TGA 33.530 FDLS, FDLS/M, FDLRS	07/2003 -	B 180 APC	B 180 EHD	B 185 APC	
TGA 33.530 FDS	09/2002 -	B 180 APC	B 180 EHD	B 185 APC	
TGA 35.310 FFDC	06/2003 -	B 180 APC	B 180 EHD	B 185 APC	
TGA 35.310 FFDK	06/2003 -	B 180 APC	B 180 EHD	B 185 APC	
TGA 35.310 FFD-TM	11/2003 -	B 180 APC	B 180 EHD	B 185 APC	
TGA 35.310, 35.320 FFDC, FFDLC	02/2004 -	B 180 APC	B 180 EHD	B 185 APC	
TGA 35.310, 35.320 FFDK, FFDLK	02/2004 -	B 180 APC	B 180 EHD	B 185 APC	
TGA 35.310, 35.320 FFD-TM	02/2004 -	B 180 APC	B 180 EHD	B 185 APC	
TGA 35.350 FFDHK, FFDHLK	07/2006 -	B 180 APC	B 180 EHD	B 185 APC	
TGA 35.350 FFDH-TM	07/2006 -	B 180 APC	B 180 EHD	B 185 APC	
TGA 35.350 FFNLC	07/2006 -	B 180 APC	B 180 EHD	B 185 APC	
TGA 35.350, 35.360 FFDC, FFDRC, FFDLC	02/2004 -	B 180 APC	B 180 EHD	B 185 APC	
TGA 35.350, 35.360 FFDK, FFDRC, FFDLK	02/2004 -	B 180 APC	B 180 EHD	B 185 APC	
TGA 35.350, 35.360 FFD-TM	02/2004 -	B 180 APC	B 180 EHD	B 185 APC	
TGA 35.360 FFDC, FFDLC	10/2003 -	B 180 APC	B 180 EHD	B 185 APC	
TGA 35.360 FFDHK, FFDHLK	07/2006 -	B 180 APC	B 180 EHD	B 185 APC	
TGA 35.360 FFDH-TM	07/2006 -	B 180 APC	B 180 EHD	B 185 APC	
TGA 35.360 FFDK	10/2003 -	B 180 APC	B 180 EHD	B 185 APC	
TGA 35.360 FFD-TM	11/2003 -	B 180 APC	B 180 EHD	B 185 APC	
TGA 35.360 FFNHLK	07/2006 -	B 180 APC	B 180 EHD	B 185 APC	
TGA 35.360 FFNLC	07/2006 -	B 180 APC	B 180 EHD	B 185 APC	
TGA 35.390 FDNLC	07/2006 -	B 180 APC	B 180 EHD	B 185 APC	
TGA 35.390 FFDAK	02/2004 -	B 180 APC	B 180 EHD	B 185 APC	
TGA 35.390 FFDAK, FFDHK, FFDHLK	07/2006 -	B 180 APC	B 180 EHD	B 185 APC	
TGA 35.390 FFDH-TM	07/2006 -	B 180 APC	B 180 EHD	B 185 APC	
TGA 35.390 FFNLC	07/2006 -	B 180 APC	B 180 EHD	B 185 APC	
TGA 35.390, 35.400 FFDC, FFDRC, FFDLC	02/2004 -	B 180 APC	B 180 EHD	B 185 APC	

MARCHIO E MODELLO - MAKE AND MODEL MARQUE ET MODÈLE - MARKE UND MODELL MARCA Y MODELO - МАРКА И МОДЕЛЬ	Periodo Period	powerCUBE		energyCUBE	
		APC	EHD	APC	RST
MAN					
<i>cont.</i>					
TGA 35.390, 35.400 FFDK, FFDK, FFDLK	02/2004 -	B 180 APC	B 180 EHD	B 185 APC	
TGA 35.390, 35.400 FFD-TM	02/2004 -	B 180 APC	B 180 EHD	B 185 APC	
TGA 35.400 FDNLC	07/2006 -	B 180 APC	B 180 EHD	B 185 APC	
TGA 35.400 FFDK	02/2004 -	B 180 APC	B 180 EHD	B 185 APC	
TGA 35.400 FFDK, FFDHK, FFDHLK	07/2006 -	B 180 APC	B 180 EHD	B 185 APC	
TGA 35.400 FFDH-TM	07/2006 -	B 180 APC	B 180 EHD	B 185 APC	
TGA 35.400 FFNHLC	11/2006 -	B 180 APC	B 180 EHD	B 185 APC	
TGA 35.400 FFNLC	07/2006 -	B 180 APC	B 180 EHD	B 185 APC	
TGA 35.410 FDNLC	07/2006 -	B 180 APC	B 180 EHD	B 185 APC	
TGA 35.410 FFDK	07/2006 -	B 180 APC	B 180 EHD	B 185 APC	
TGA 35.410 FFDK	10/2003 -	B 180 APC	B 180 EHD	B 185 APC	
TGA 35.410 FFDK	10/2003 -	B 180 APC	B 180 EHD	B 185 APC	
TGA 35.410 FFD-TM	11/2003 -	B 180 APC	B 180 EHD	B 185 APC	
TGA 35.410 FFNLC	07/2006 -	B 180 APC	B 180 EHD	B 185 APC	
TGA 35.430 FDNLC	07/2006 -	B 180 APC	B 180 EHD	B 185 APC	
TGA 35.430 FFDK, FFDHK, FFDHLK	07/2006 -	B 180 APC	B 180 EHD	B 185 APC	
TGA 35.430 FFDH-TM	07/2006 -	B 180 APC	B 180 EHD	B 185 APC	
TGA 35.430 FFNLC	07/2006 -	B 180 APC	B 180 EHD	B 185 APC	
TGA 35.430, 35.440 FFDK, FFDRC, FFDLC	02/2004 -	B 180 APC	B 180 EHD	B 185 APC	
TGA 35.430, 35.440 FFDK, FFDK, FFDLK	02/2004 -	B 180 APC	B 180 EHD	B 185 APC	
TGA 35.430, 35.440 FFD-TM	02/2004 -	B 180 APC	B 180 EHD	B 185 APC	
TGA 35.440 FDNLC	07/2006 -	B 180 APC	B 180 EHD	B 185 APC	
TGA 35.440 FFDK, FFDHK, FFDHLK	07/2006 -	B 180 APC	B 180 EHD	B 185 APC	
TGA 35.440 FFDH-TM	07/2006 -	B 180 APC	B 180 EHD	B 185 APC	
TGA 35.440 FFNHLC	11/2006 -	B 180 APC	B 180 EHD	B 185 APC	
TGA 35.440 FFNLC	07/2006 -	B 180 APC	B 180 EHD	B 185 APC	
TGA 35.460 FFDK	10/2003 -	B 180 APC	B 180 EHD	B 185 APC	
TGA 35.460 FFDK	10/2003 -	B 180 APC	B 180 EHD	B 185 APC	
TGA 35.460 FFD-TM	11/2003 -	B 180 APC	B 180 EHD	B 185 APC	
TGA 35.460 FFNLC	07/2006 -	B 180 APC	B 180 EHD	B 185 APC	
TGA 35.480 FDNLC	07/2006 -	B 180 APC	B 180 EHD	B 185 APC	
TGA 35.480 FFDK	07/2006 -	B 180 APC	B 180 EHD	B 185 APC	
TGA 35.480 FFDK, FFDHK, FFDHLK	07/2006 -	B 180 APC	B 180 EHD	B 185 APC	
TGA 35.480 FFDARS	07/2006 -	B 180 APC	B 180 EHD	B 185 APC	
TGA 35.480 FFDK	10/2003 -	B 180 APC	B 180 EHD	B 185 APC	
TGA 35.480 FFDK, FFDLC	02/2004 -	B 180 APC	B 180 EHD	B 185 APC	
TGA 35.480 FFDH-TM	07/2006 -	B 180 APC	B 180 EHD	B 185 APC	
TGA 35.480 FFDK	02/2004 -	B 180 APC	B 180 EHD	B 185 APC	
TGA 35.480 FFDK	10/2003 -	B 180 APC	B 180 EHD	B 185 APC	
TGA 35.480 FFD-TM	02/2004 -	B 180 APC	B 180 EHD	B 185 APC	
TGA 35.480 FFD-TM	11/2003 -	B 180 APC	B 180 EHD	B 185 APC	
TGA 35.480 FFNHLC	11/2006 -	B 180 APC	B 180 EHD	B 185 APC	
TGA 35.480 FFNLC	07/2006 -	B 180 APC	B 180 EHD	B 185 APC	
TGA 35.530 FDNLC	04/2004 -	B 180 APC	B 180 EHD	B 185 APC	
TGA 35.530 FFDK	07/2006 -	B 180 APC	B 180 EHD	B 185 APC	

MARCHIO E MODELLO - MAKE AND MODEL MARQUE ET MODÈLE - MARKE UND MODELL MARCA Y MODELO - МАРКА И МОДЕЛЬ	Periodo Period	powerCUBE		energyCUBE	
		APC	EHD	APC	RST
MAN					
<i>cont.</i>					
TGA 35.530 FFDC	04/2004 -	B 180 APC	B 180 EHD	B 185 APC	
TGA 35.530 FFDK	04/2004 -	B 180 APC	B 180 EHD	B 185 APC	
TGA 35.530 FFD-TM	04/2004 -	B 180 APC	B 180 EHD	B 185 APC	
TGA 35.530 FFNLC	07/2006 -	B 180 APC	B 180 EHD	B 185 APC	
TGA 37.310 FFDC	12/2004 -	B 180 APC	B 180 EHD	B 185 APC	
TGA 37.310 FFDK	12/2004 -	B 180 APC	B 180 EHD	B 185 APC	
TGA 37.310 FFD-TM	12/2004 -	B 180 APC	B 180 EHD	B 185 APC	
TGA 37.310, 37.320 FFDC	12/2004 -	B 180 APC	B 180 EHD	B 185 APC	
TGA 37.310, 37.320 FFDK	12/2004 -	B 180 APC	B 180 EHD	B 185 APC	
TGA 37.310, 37.320 FFD-TM	12/2004 -	B 180 APC	B 180 EHD	B 185 APC	
TGA 37.350, 37.360 FFDC	12/2004 -	B 180 APC	B 180 EHD	B 185 APC	
TGA 37.350, 37.360 FFDK	12/2004 -	B 180 APC	B 180 EHD	B 185 APC	
TGA 37.350, 37.360 FFD-TM	12/2004 -	B 180 APC	B 180 EHD	B 185 APC	
TGA 37.360 FFDC	12/2004 -	B 180 APC	B 180 EHD	B 185 APC	
TGA 37.360 FFDK	12/2004 -	B 180 APC	B 180 EHD	B 185 APC	
TGA 37.360 FFD-TM	12/2004 -	B 180 APC	B 180 EHD	B 185 APC	
TGA 37.390, 37.400 FFDC	12/2004 -	B 180 APC	B 180 EHD	B 185 APC	
TGA 37.390, 37.400 FFDK	12/2004 -	B 180 APC	B 180 EHD	B 185 APC	
TGA 37.390, 37.400 FFD-TM	12/2004 -	B 180 APC	B 180 EHD	B 185 APC	
TGA 37.410 FFDC	12/2004 -	B 180 APC	B 180 EHD	B 185 APC	
TGA 37.410 FFDK	12/2004 -	B 180 APC	B 180 EHD	B 185 APC	
TGA 37.410 FFD-TM	12/2004 -	B 180 APC	B 180 EHD	B 185 APC	
TGA 37.430, 37.440 FFDC	12/2004 -	B 180 APC	B 180 EHD	B 185 APC	
TGA 37.430, 37.440 FFDK	12/2004 -	B 180 APC	B 180 EHD	B 185 APC	
TGA 37.430, 37.440 FFD-TM	12/2004 -	B 180 APC	B 180 EHD	B 185 APC	
TGA 37.460 FFDC	12/2004 -	B 180 APC	B 180 EHD	B 185 APC	
TGA 37.460 FFDK	12/2004 -	B 180 APC	B 180 EHD	B 185 APC	
TGA 37.460 FFD-TM	12/2004 -	B 180 APC	B 180 EHD	B 185 APC	
TGA 37.480 FFDC	02/2006 -	B 180 APC	B 180 EHD	B 185 APC	
TGA 37.480 FFDK	12/2004 -	B 180 APC	B 180 EHD	B 185 APC	
TGA 37.480 FFDK	02/2006 -	B 180 APC	B 180 EHD	B 185 APC	
TGA 37.480 FFDK	12/2004 -	B 180 APC	B 180 EHD	B 185 APC	
TGA 37.480 FFD-TM	02/2006 -	B 180 APC	B 180 EHD	B 185 APC	
TGA 37.480 FFD-TM	12/2004 -	B 180 APC	B 180 EHD	B 185 APC	
TGA 37.530 FFDC	12/2004 -	B 180 APC	B 180 EHD	B 185 APC	
TGA 37.530 FFDK	12/2004 -	B 180 APC	B 180 EHD	B 185 APC	
TGA 37.530 FFD-TM	12/2004 -	B 180 APC	B 180 EHD	B 185 APC	
TGA 37.530 FVDS, FVDLS	07/2006 -	B 180 APC	B 180 EHD	B 185 APC	
TGA 39.390 FVNLC	07/2006 -	B 180 APC	B 180 EHD	B 185 APC	
TGA 39.400 FVNLC	07/2006 -	B 180 APC	B 180 EHD	B 185 APC	
TGA 39.430 FVNLC	07/2006 -	B 180 APC	B 180 EHD	B 185 APC	
TGA 39.440 FVNLC	07/2006 -	B 180 APC	B 180 EHD	B 185 APC	
TGA 39.480 FVNLC	07/2006 -	B 180 APC	B 180 EHD	B 185 APC	
TGA 40.390 FDK-WW	06/2005 -	B 180 APC	B 180 EHD	B 185 APC	
TGA 40.390 FDS-WW	06/2005 -	B 180 APC	B 180 EHD	B 185 APC	

MARCHIO E MODELLO - MAKE AND MODEL MARQUE ET MODÈLE - MARKE UND MODELL MARCA Y MODELO - МАРКА И МОДЕЛЬ	Periodo Period	powerCUBE		energyCUBE	
		APC	EHD	APC	RST
MAN					
<i>cont.</i>					
TGA 40.390, 40.400 FDAK-WW	06/2005 -	B 180 APC	B 180 EHD	B 185 APC	
TGA 40.390, 40.400 FDAS-WW	06/2005 -	B 180 APC	B 180 EHD	B 185 APC	
TGA 40.410 FDAK-WW	04/2004 -	B 180 APC	B 180 EHD	B 185 APC	
TGA 40.410 FDAS-WW	04/2004 -	B 180 APC	B 180 EHD	B 185 APC	
TGA 40.410 FDK-WW	04/2004 -	B 180 APC	B 180 EHD	B 185 APC	
TGA 40.410 FDS-WW	04/2004 -	B 180 APC	B 180 EHD	B 185 APC	
TGA 40.430 FDS-WW	06/2005 -	B 180 APC	B 180 EHD	B 185 APC	
TGA 40.430, 40.440 FDAK-WW	06/2005 -	B 180 APC	B 180 EHD	B 185 APC	
TGA 40.430, 40.440 FDAS-WW	06/2005 -	B 180 APC	B 180 EHD	B 185 APC	
TGA 40.440 FDAK-WW	06/2005 -	B 180 APC	B 180 EHD	B 185 APC	
TGA 40.440 FDAS-WW	06/2005 -	B 180 APC	B 180 EHD	B 185 APC	
TGA 40.440 FDK-WW, FDRK	06/2005 -	B 180 APC	B 180 EHD	B 185 APC	
TGA 40.440 FDS-WW, FDRS	06/2005 -	B 180 APC	B 180 EHD	B 185 APC	
TGA 40.460 FDAK-WW	04/2004 -	B 180 APC	B 180 EHD	B 185 APC	
TGA 40.460 FDAS-WW	04/2004 -	B 180 APC	B 180 EHD	B 185 APC	
TGA 40.460 FDK-WW	04/2004 -	B 180 APC	B 180 EHD	B 185 APC	
TGA 40.460 FDS-WW	04/2004 -	B 180 APC	B 180 EHD	B 185 APC	
TGA 40.480 FDAK-WW	04/2004 -	B 180 APC	B 180 EHD	B 185 APC	
TGA 40.480 FDAK-WW	06/2005 -	B 180 APC	B 180 EHD	B 185 APC	
TGA 40.480 FDAS-WW	04/2004 -	B 180 APC	B 180 EHD	B 185 APC	
TGA 40.480 FDAS-WW	06/2005 -	B 180 APC	B 180 EHD	B 185 APC	
TGA 40.480 FDK-WW	04/2004 -	B 180 APC	B 180 EHD	B 185 APC	
TGA 40.480 FDK-WW, FDRK	06/2005 -	B 180 APC	B 180 EHD	B 185 APC	
TGA 40.480 FDS-WW	04/2004 -	B 180 APC	B 180 EHD	B 185 APC	
TGA 40.480 FDS-WW FDRS	06/2005 -	B 180 APC	B 180 EHD	B 185 APC	
TGA 41.350 FFDC-TM, FFDRK-TM	09/2007 -	B 180 APC	B 180 EHD	B 185 APC	
TGA 41.350, 41.360 FFDC	12/2004 -	B 180 APC	B 180 EHD	B 185 APC	
TGA 41.350, 41.360 FFDK	12/2004 -	B 180 APC	B 180 EHD	B 185 APC	
TGA 41.350, 41.360 FFD-TM	12/2004 -	B 180 APC	B 180 EHD	B 185 APC	
TGA 41.360 FFD	12/2008 -	B 180 APC	B 180 EHD	B 185 APC	
TGA 41.360 FFDC	01/2003 -	B 180 APC	B 180 EHD	B 185 APC	
TGA 41.360 FFDC-TM, FDRK-TM	09/2007 -	B 180 APC	B 180 EHD	B 185 APC	
TGA 41.360 FFDK-WW	09/2003 -	B 180 APC	B 180 EHD	B 185 APC	
TGA 41.360 FFD-TM	12/2004 -	B 180 APC	B 180 EHD	B 185 APC	
TGA 41.390 FFDAK	12/2004 -	B 180 APC	B 180 EHD	B 185 APC	
TGA 41.390 FFDC-TM, FDRK-TM	09/2007 -	B 180 APC	B 180 EHD	B 185 APC	
TGA 41.390, 41.400 FFDC, FFDC/M	12/2004 -	B 180 APC	B 180 EHD	B 185 APC	
TGA 41.390, 41.400 FFDK	12/2004 -	B 180 APC	B 180 EHD	B 185 APC	
TGA 41.390, 41.400 FFD-TM	12/2004 -	B 180 APC	B 180 EHD	B 185 APC	
TGA 41.400 FFD	12/2008 -	B 180 APC	B 180 EHD	B 185 APC	
TGA 41.400 FFDC-TM, FDRK-TM	09/2007 -	B 180 APC	B 180 EHD	B 185 APC	
TGA 41.410 FFDAK	07/2006 -	B 180 APC	B 180 EHD	B 185 APC	
TGA 41.410 FFDC-WW	09/2003 -	B 180 APC	B 180 EHD	B 185 APC	
TGA 41.410 FFDK-WW	09/2003 -	B 180 APC	B 180 EHD	B 185 APC	
TGA 41.410 FFD-TM	12/2004 -	B 180 APC	B 180 EHD	B 185 APC	

MARCHIO E MODELLO - MAKE AND MODEL MARQUE ET MODÈLE - MARKE UND MODELL MARCA Y MODELO - МАРКА И МОДЕЛЬ	Periodo Period	powerCUBE		energyCUBE	
		APC	EHD	APC	RST
MAN					
cont.					
TGA 41.430 FFDK	07/2006 -	B 180 APC	B 180 EHD	B 185 APC	
TGA 41.430 FFDK	12/2004 -	B 180 APC	B 180 EHD	B 185 APC	
TGA 41.430 FFDC-TM, FFDR	09/2007 -	B 180 APC	B 180 EHD	B 185 APC	
TGA 41.430, 41.440 FFDC, FFDC/M	12/2004 -	B 180 APC	B 180 EHD	B 185 APC	
TGA 41.430, 41.440 FFDK	12/2004 -	B 180 APC	B 180 EHD	B 185 APC	
TGA 41.430, 41.440 FFD-TM	12/2004 -	B 180 APC	B 180 EHD	B 185 APC	
TGA 41.440 FFD/M	12/2004 -	B 180 APC	B 180 EHD	B 185 APC	
TGA 41.440 FFDK	07/2006 -	B 180 APC	B 180 EHD	B 185 APC	
TGA 41.440 FFDC, FFDR	12/2004 -	B 180 APC	B 180 EHD	B 185 APC	
TGA 41.440 FFDC-TM, FFDR-TM	09/2007 -	B 180 APC	B 180 EHD	B 185 APC	
TGA 41.440 FFDK, FDRK	12/2004 -	B 180 APC	B 180 EHD	B 185 APC	
TGA 41.460 FFDC-WW	09/2003 -	B 180 APC	B 180 EHD	B 185 APC	
TGA 41.460 FFDK-WW	09/2003 -	B 180 APC	B 180 EHD	B 185 APC	
TGA 41.460 FFD-TM	12/2004 -	B 180 APC	B 180 EHD	B 185 APC	
TGA 41.480 FFD	12/2008 -	B 180 APC	B 180 EHD	B 185 APC	
TGA 41.480 FFDK	07/2006 -	B 180 APC	B 180 EHD	B 185 APC	
TGA 41.480 FFDARC	07/2006 -	B 180 APC	B 180 EHD	B 185 APC	
TGA 41.480 FFDC, FFDC/M	02/2006 -	B 180 APC	B 180 EHD	B 185 APC	
TGA 41.480 FFDC-TM, FFDR-TM	09/2007 -	B 180 APC	B 180 EHD	B 185 APC	
TGA 41.480 FFDC-WW	06/2005 -	B 180 APC	B 180 EHD	B 185 APC	
TGA 41.480 FFDK	02/2006 -	B 180 APC	B 180 EHD	B 185 APC	
TGA 41.480 FFDK-WW	06/2005 -	B 180 APC	B 180 EHD	B 185 APC	
TGA 41.480 FFD-TM	02/2006 -	B 180 APC	B 180 EHD	B 185 APC	
TGA 41.480 FFD-TM	12/2004 -	B 180 APC	B 180 EHD	B 185 APC	
TGA 41.480 FVDS, FVDLS	07/2006 -	B 180 APC	B 180 EHD	B 185 APC	
TGA 41.530 FFDK	07/2006 -	B 180 APC	B 180 EHD	B 185 APC	
TGA 41.530 FFDC	12/2004 -	B 180 APC	B 180 EHD	B 185 APC	
TGA 41.530 FFDK	12/2004 -	B 180 APC	B 180 EHD	B 185 APC	
TGA 41.530 FFD-TM	12/2004 -	B 180 APC	B 180 EHD	B 185 APC	
TGA 41.530 FVDS, FVDLS	09/2002 -	B 180 APC	B 180 EHD	B 185 APC	
TGA 41.540 FVDLS	11/2006 -	B 180 APC	B 180 EHD	B 185 APC	
TGA 41.660 FVDS	09/2002 -	B 180 APC	B 180 EHD	B 185 APC	
TGL 10.180 FC,FRC, FLC, FLRC	04/2005 -	A 135 APC	A 140 EHD		
TGL 10.180 FK, FRK	04/2005 -	A 135 APC	A 140 EHD		
TGL 10.210 FC, FRC, FLC, FLRC	04/2005 -	A 135 APC	A 140 EHD		
TGL 10.210 FK, FRK	04/2005 -	A 135 APC	A 140 EHD		
TGL 10.220 FC, FLC, FRC, FLRC	04/2005 -	A 135 APC	A 140 EHD		
TGL 10.220 FK, FRK	04/2005 -	A 135 APC	A 140 EHD		
TGL 10.240 FC, FRC, FLC, FLRC	04/2005 -	A 135 APC	A 140 EHD		
TGL 10.240 FK, FRK	04/2005 -	A 135 APC	A 140 EHD		
TGL 10.250 FC, FLC, FRC, FLRC	04/2005 -	A 135 APC	A 140 EHD		
TGL 10.250 FK, FRK	04/2005 -	A 135 APC	A 140 EHD		
TGL 12.180 FC,FRC, FLC, FLRC	04/2005 -	A 135 APC	A 140 EHD		
TGL 12.180 FK, FRK	04/2005 -	A 135 APC	A 140 EHD		
TGL 12.210 FC, FRC, FLC, FLRC	04/2005 -	A 135 APC	A 140 EHD		

MARCHIO E MODELLO - MAKE AND MODEL MARQUE ET MODÈLE - MARKE UND MODELL MARCA Y MODELO - МАРКА И МОДЕЛЬ	Periodo Period	powerCUBE		energyCUBE	
		APC	EHD	APC	RST
MAN					
<i>cont.</i>					
TGL 12.210 FK, FRK	04/2005 -	A 135 APC	A 140 EHD		
TGL 12.220 FC, FRC, FLC, FLRC	04/2005 -	A 135 APC	A 140 EHD		
TGL 12.220 FK, FRK	04/2005 -	A 135 APC	A 140 EHD		
TGL 12.240 FC, FRC, FLC, FLRC	04/2005 -	A 135 APC	A 140 EHD		
TGL 12.240 FK, FRK	04/2005 -	A 135 APC	A 140 EHD		
TGL 12.250 FC, FLC, FRC, FLRC	04/2005 -	A 135 APC	A 140 EHD		
TGL 12.250 FK	04/2005 -	A 135 APC	A 140 EHD		
TGL 7.150 FC,FRC, FLC, FLRC	04/2005 -	A 135 APC	A 140 EHD		
TGL 7.180 FC,FRC, FLC, FLRC	04/2005 -	A 135 APC	A 140 EHD		
TGL 7.220 FC, FLC, FRC, FLRC	04/2005 -	A 135 APC	A 140 EHD		
TGL 7.250 FC, FLC, FRC, FLRC	04/2005 -	A 135 APC	A 140 EHD		
TGL 8.150 FK, FK-L	10/2006 -	A 135 APC	A 140 EHD		
TGL 8.180 FC,FRC, FLC, FLRC	04/2005 -	A 135 APC	A 140 EHD		
TGL 8.180 FK,FK-L, FRK, FRK-L	04/2005 -	A 135 APC	A 140 EHD		
TGL 8.210 FC, FRC, FLC, FLRC	04/2005 -	A 135 APC	A 140 EHD		
TGL 8.210 FK, FK-L, FRK, FRK-L	04/2005 -	A 135 APC	A 140 EHD		
TGL 8.220 FC, FLC, FRC, FLRC	04/2005 -	A 135 APC	A 140 EHD		
TGL 8.220 FK, FRK, FK-L, FRK-L	04/2005 -	A 135 APC	A 140 EHD		
TGL 8.240 FC, FRC, FLC, FLRC	04/2005 -	A 135 APC	A 140 EHD		
TGL 8.240 FK, FK-L, FRK, FRK-L	04/2005 -	A 135 APC	A 140 EHD		
TGL 8.250 FC, FLC, FLRC, FRC	04/2005 -	A 135 APC	A 140 EHD		
TGL 8.250 FK, FK-L, FRK-L	04/2005 -	A 135 APC	A 140 EHD		
TGM 12.240 FLC, FLLC	12/2005 -	A 135 APC	A 140 EHD		
TGM 12.250 FLC, FLLC	10/2005 -	A 135 APC	A 140 EHD		
TGM 12.280 FC, FLLC	12/2005 -	A 135 APC	A 140 EHD		
TGM 12.290 FLC, FLLC	10/2005 -	A 135 APC	A 140 EHD		
TGM 13.240 FALC, FALRC	05/2006 -	A 135 APC	A 140 EHD		
TGM 13.240 FALK, FALRK, FALK-L, FALRK-L	05/2006 -	A 135 APC	A 140 EHD		
TGM 13.250 FALK, FALRK	10/2005 -	A 135 APC	A 140 EHD		
TGM 13.250 FAEC, FAERC, FALC, FAL, FALRC, FALR	10/2005 -	A 135 APC	A 140 EHD		
TGM 13.280 FALC, FALRC	05/2006 -	A 135 APC	A 140 EHD		
TGM 13.280 FALK, FALRK, FALK-L, FALRK-L	05/2006 -	A 135 APC	A 140 EHD		
TGM 13.290 FAEC, FAERC, FAL, FALR, FALC, FALRC	10/2005 -	A 135 APC	A 140 EHD		
TGM 13.290 FALK, FALRK	10/2005 -	A 135 APC	A 140 EHD		
TGM 15.240 FLC, FLLC, FLRC, FLLRC	10/2005 -	A 135 APC	A 140 EHD		
TGM 15.240 FLK, FLRK	10/2005 -	A 135 APC	A 140 EHD		
TGM 15.250 FC, FLC, FLRC, FLLC, FLLRC	10/2005 -	A 135 APC	A 140 EHD		
TGM 15.250 FLK, FLRK	10/2005 -	A 135 APC	A 140 EHD		
TGM 15.280 FLC, FLLC, FLRC, FLLRC	10/2005 -	A 135 APC	A 140 EHD		
TGM 15.280 FLK, FLRK	10/2005 -	A 135 APC	A 140 EHD		
TGM 15.290 FC, FLC, FLRC, FLLC, FLLRC	10/2005 -	A 135 APC	A 140 EHD		
TGM 15.290 FLK, FLRK	10/2005 -	A 135 APC	A 140 EHD		
TGM 15.330 FC, FLC, FRC, FLRC	10/2005 -	A 135 APC	A 140 EHD		
TGM 15.330 FLK, FLRK	10/2005 -	A 135 APC	A 140 EHD		
TGM 15.340 FC, FLC, FLRC	10/2005 -	A 135 APC	A 140 EHD		

MARCHIO E MODELLO - MAKE AND MODEL MARQUE ET MODÈLE - MARKE UND MODELL MARCA Y MODELO - МАРКА И МОДЕЛЬ	Periodo Period	powerCUBE		energyCUBE	
		APC	EHD	APC	RST
MAN					
cont.					
TGM 15.340 FLK, FLRK	10/2005 -	A 135 APC	A 140 EHD		
TGM 18.240 FAC, FARC	10/2005 -	A 135 APC	A 140 EHD		
TGM 18.240 FAK, FARK	05/2006 -	A 135 APC	A 140 EHD		
TGM 18.240 FC, FRC, FLC, FLRC	10/2005 -	A 135 APC	A 140 EHD		
TGM 18.240 FK, FRK, FK-L	10/2005 -	A 135 APC	A 140 EHD		
TGM 18.250 FAC, FARC	10/2005 -	A 135 APC	A 140 EHD		
TGM 18.250 FAK, FARK	10/2005 -	A 135 APC	A 140 EHD		
TGM 18.250 FC, FLC, FLRC, FLLC, FLLRC,	10/2005 -	A 135 APC	A 140 EHD		
TGM 18.250 FK, FLK, FRK, FLRK	10/2005 -	A 135 APC	A 140 EHD		
TGM 18.280 FAC, FARC	10/2005 -	A 135 APC	A 140 EHD		
TGM 18.280 FAK, FARK	10/2005 -	A 135 APC	A 140 EHD		
TGM 18.280 FC, FRC, FLC, FLRC	10/2005 -	A 135 APC	A 140 EHD		
TGM 18.280 FK, FRK, FK-L	10/2005 -	A 135 APC	A 140 EHD		
TGM 18.290 FAC, FARC	10/2005 -	A 135 APC	A 140 EHD		
TGM 18.290 FAK, FARK	10/2005 -	A 135 APC	A 140 EHD		
TGM 18.290 FC, FLC, FRC, FLRC, FLLC, FLLRC	10/2005 -	A 135 APC	A 140 EHD		
TGM 18.290 FK, FLK, FRK, FLRK	10/2005 -	A 135 APC	A 140 EHD		
TGM 18.330 FAC, FARC	10/2005 -	A 135 APC	A 140 EHD		
TGM 18.330 FAK, FARK	10/2005 -	A 135 APC	A 140 EHD		
TGM 18.330 FC, FRC	10/2005 -	A 135 APC	A 140 EHD		
TGM 18.330 FK, FRK, FK-L	10/2005 -	A 135 APC	A 140 EHD		
TGM 18.340 FAC, FARC	10/2005 -	A 135 APC	A 140 EHD		
TGM 18.340 FAK, FARK	10/2005 -	A 135 APC	A 140 EHD		
TGM 18.340 FC, FLC, FLRC, FLLC, FLLRC, FRC	10/2005 -	A 135 APC	A 140 EHD		
TGM 18.340 FK, FRK, FLK, FLRK	10/2005 -	A 135 APC	A 140 EHD		
TGM 22.240 FNLLC	10/2005 -	A 135 APC	A 140 EHD		
TGM 22.250 FNLLC	10/2005 -	A 135 APC	A 140 EHD		
TGM 22.280 FNLLC	10/2005 -	A 135 APC	A 140 EHD		
TGM 22.290 FNLLC	10/2005 -	A 135 APC	A 140 EHD		
TGM 26.280 FD	10/2005 -	A 135 APC	A 140 EHD		
TGM 26.280 FDRK-HK	04/2006 -	A 135 APC	A 140 EHD		
TGM 26.280 FDR-TM	04/2006 -	A 135 APC	A 140 EHD		
TGM 26.280 FNLC, FNLLC, FNLRC, FNLLRC	10/2005 -	A 135 APC	A 140 EHD		
TGM 26.290 FD, FDR	10/2005 -	A 135 APC	A 140 EHD		
TGM 26.290 FDK, FDRK	10/2005 -	A 135 APC	A 140 EHD		
TGM 26.290 FD-TM, FDR-TM	07/2008 -	A 135 APC	A 140 EHD		
TGM 26.290 FNLC, FNLLC, FNLRC, FNLLRC	10/2005 -	A 135 APC	A 140 EHD		
TGM 26.330 FD, FDR	10/2005 -	A 135 APC	A 140 EHD		
TGM 26.330 FDRK-HK	04/2006 -	A 135 APC	A 140 EHD		
TGM 26.330 FDR-TM	04/2006 -	A 135 APC	A 140 EHD		
TGM 26.330 FNLC, FNLLC, FNLRC, FNLLRC	10/2005 -	A 135 APC	A 140 EHD		
TGM 26.340 FD, FDR	10/2005 -	A 135 APC	A 140 EHD		
TGM 26.340 FDK, FDRK-HK	10/2005 -	A 135 APC	A 140 EHD		
TGM 26.340 FDR-TM	07/2008 -	A 135 APC	A 140 EHD		
TGM 26.340 FNLC, FNLLC, FNLRC, FNLLRC	10/2005 -	A 135 APC	A 140 EHD		

MARCHIO E MODELLO - MAKE AND MODEL MARQUE ET MODÈLE - MARKE UND MODELL MARCA Y MODELO - МАРКА И МОДЕЛЬ	Periodo Period	powerCUBE		energyCUBE	
		APC	EHD	APC	RST
MAN					
<i>cont.</i>					
TGS 18.320 FAC, FHLC	10/2007 -	B 180 APC	B 180 EHD	B 185 APC	
TGS 18.320 FAK, FAK-L, FALK, FALK-L, FHLK, FHLK/M	10/2007 -	B 180 APC	B 180 EHD	B 185 APC	
TGS 18.320 FAS, FHLS, FHLS/M	10/2007 -	B 180 APC	B 180 EHD	B 185 APC	
TGS 18.320 FC, FLC, FLRC, FLLC, FLLRC, FLLW, FLLW/N	10/2007 -	B 180 APC	B 180 EHD	B 185 APC	
TGS 18.320 FK, FK-L, FLK, FLK/M	10/2007 -	B 180 APC	B 180 EHD	B 185 APC	
TGS 18.320 FLS, FLS/M, FLS-TS, FLRS, FLRS/M, FLLS, FLLS/N, FLLRS	10/2007 -	B 180 APC	B 180 EHD	B 185 APC	
TGS 18.360 FAC, FHLC	10/2007 -	B 180 APC	B 180 EHD	B 185 APC	
TGS 18.360 FAK, FAK-L, FALK, FALK-L, FHLK, FHLK/M	10/2007 -	B 180 APC	B 180 EHD	B 185 APC	
TGS 18.360 FAS, FHLS, FHLS/M	10/2007 -	B 180 APC	B 180 EHD	B 185 APC	
TGS 18.360 FC, FLC, FLRC, FLLC, FLLRC, FLLW, FLLW/N	10/2007 -	B 180 APC	B 180 EHD	B 185 APC	
TGS 18.360 FK, FK-L, FLK, FLK/M	10/2007 -	B 180 APC	B 180 EHD	B 185 APC	
TGS 18.360 FLS, FLS/M, FLS-TS, FLRS, FLRS/M, FLLS, FLLS/N, FLLRS	10/2007 -	B 180 APC	B 180 EHD	B 185 APC	
TGS 18.400 FAC, FHLC	10/2007 -	B 180 APC	B 180 EHD	B 185 APC	
TGS 18.400 FAK, FAK-L, FALK, FALK-L, FHLK, FHLK/M	10/2007 -	B 180 APC	B 180 EHD	B 185 APC	
TGS 18.400 FAS, FALS, FHLS, FHLS/M	10/2007 -	B 180 APC	B 180 EHD	B 185 APC	
TGS 18.400 FC, FLC, FLRC, FLLC, FLLRC, FLLW, FLLW/N	10/2007 -	B 180 APC	B 180 EHD	B 185 APC	
TGS 18.400 FK, FK-L, FLK, FLK/M	10/2007 -	B 180 APC	B 180 EHD	B 185 APC	
TGS 18.400 FLS, FLS/M, FLS-TS, FLRS, FLRS/M, FLLS, FLLS/N, FLLRS	10/2007 -	B 180 APC	B 180 EHD	B 185 APC	
TGS 18.440 FAC, FHLC	10/2007 -	B 180 APC	B 180 EHD	B 185 APC	
TGS 18.440 FAK, FAK-L, FALK, FALK-L, FHLK, FHLK/M	10/2007 -	B 180 APC	B 180 EHD	B 185 APC	
TGS 18.440 FAS, FALS, FHLS, FHLS/M	10/2007 -	B 180 APC	B 180 EHD	B 185 APC	
TGS 18.440 FC, FLC, FLRC, FLLC, FLLRC, FLLW, FLLW/N	10/2007 -	B 180 APC	B 180 EHD	B 185 APC	
TGS 18.440 FK, FK-L, FLK, FLK/M	10/2007 -	B 180 APC	B 180 EHD	B 185 APC	
TGS 18.440 FLS, FLS/M, FLS-TS, FLRS, FLRS/M, FLLS, FLLS/N, FLLRS	10/2007 -	B 180 APC	B 180 EHD	B 185 APC	
TGS 18.480 FAC, FHLC	10/2007 -	B 180 APC	B 180 EHD	B 185 APC	
TGS 18.480 FAK, FAK-L, FALK, FALK-L	10/2007 -	B 180 APC	B 180 EHD	B 185 APC	
TGS 18.480 FAS, FALS, FHLS	10/2007 -	B 180 APC	B 180 EHD	B 185 APC	
TGS 18.480 FC, FLC, FLRC, FLLC, FLLRC, FLLW, FLLW/N	10/2007 -	B 180 APC	B 180 EHD	B 185 APC	
TGS 18.480 FK, FK-L, FLK, FLK/M	10/2007 -	B 180 APC	B 180 EHD	B 185 APC	
TGS 18.480 FLS, FLS/M, FLS-TS, FLRS, FLRS/M, FLLS, FLLS/N, FLLRS	10/2007 -	B 180 APC	B 180 EHD	B 185 APC	
TGS 18.540 FAC, FHLC	10/2007 -	B 180 APC	B 180 EHD	B 185 APC	
TGS 18.540 FAK, FAK-L, FALK, FALK-L, FHLK, FHLK/M	10/2007 -	B 180 APC	B 180 EHD	B 185 APC	
TGS 18.540 FAS, FALS, FHLS, FHLS/M	10/2007 -	B 180 APC	B 180 EHD	B 185 APC	
TGS 18.540 FC, FLC, FLRC, FLLC, FLLRC, FLLW, FLLW/N	10/2007 -	B 180 APC	B 180 EHD	B 185 APC	
TGS 18.540 FK, FK-L, FLK, FLK/M	10/2007 -	B 180 APC	B 180 EHD	B 185 APC	
TGS 18.540 FLS, FLS/M, FLRS, FLRS/M, FLLS, FLLS/N, FLLRS	10/2007 -	B 180 APC	B 180 EHD	B 185 APC	
TGS 19.360	02/2011 -	B 180 APC		B 185 APC	
TGS 19.400	02/2011 -	B 180 APC		B 185 APC	
TGS 19.440	02/2011 -	B 180 APC		B 185 APC	
TGS 19.440 FS-WW, FRS-WW, FLS-WW, FLRS-WW	02/2011 -	B 180 APC		B 185 APC	
TGS 19.480	02/2011 -	B 180 APC		B 185 APC	
TGS 24.320 FNLLW/N	10/2007 -	B 180 APC	B 180 EHD	B 185 APC	
TGS 24.360 FNLLW/N	10/2007 -	B 180 APC	B 180 EHD	B 185 APC	
TGS 24.360 FPLS, FPLRS	10/2007 -	B 180 APC	B 180 EHD	B 185 APC	
TGS 24.400 FNLLW/N	10/2007 -	B 180 APC	B 180 EHD	B 185 APC	

MARCHIO E MODELLO - MAKE AND MODEL MARQUE ET MODÈLE - MARKE UND MODELL MARCA Y MODELO - МАРКА И МОДЕЛЬ	Periodo Period	powerCUBE		energyCUBE	
		APC	EHD	APC	RST
MAN cont.					
TGS 24.400 FPLS, FPLRS	10/2007 -	B 180 APC	B 180 EHD	B 185 APC	
TGS 24.440 FNLLW/N	10/2007 -	B 180 APC	B 180 EHD	B 185 APC	
TGS 24.440 FPLS, FPLRS	10/2007 -	B 180 APC	B 180 EHD	B 185 APC	
TGS 24.480 FPLS, FPLRS	10/2007 -	B 180 APC	B 180 EHD	B 185 APC	
TGS 24.540 FPLS, FPLRS	10/2007 -	B 180 APC	B 180 EHD	B 185 APC	
TGS 26.320 FDAC, FDALC, FDHLC, FDHLC/M,	07/2008 -	B 180 APC	B 180 EHD	B 185 APC	
TGS 26.320 FDAK, FDHLK	07/2008 -	B 180 APC	B 180 EHD	B 185 APC	
TGS 26.320 FDAS, FDHLS, FDHLS/M,	07/2008 -	B 180 APC	B 180 EHD	B 185 APC	
TGS 26.320 FDC, FDRC, FDLC, FDLC/M, FDLRC, FDLRC/M, FNHLC	07/2008 -	B 180 APC	B 180 EHD	B 185 APC	
TGS 26.320 FDK, FDLK	07/2008 -	B 180 APC	B 180 EHD	B 185 APC	
TGS 26.320 FDLS, FDLS/M, FDLRS, FDLRS/M, FNHLS	07/2008 -	B 180 APC	B 180 EHD	B 185 APC	
TGS 26.320 FD-TM	07/2008 -	B 180 APC	B 180 EHD	B 185 APC	
TGS 26.320 FNLC, FNLC, FNLLC, FNLLRC, FNLLW, FVLC	07/2008 -	B 180 APC	B 180 EHD	B 185 APC	
TGS 26.320 FNLS, FNLS, FNLLS, FPLS, FLVS	07/2008 -	B 180 APC	B 180 EHD	B 185 APC	
TGS 26.320 FVHLC	10/2007 -	B 180 APC	B 180 EHD	B 185 APC	
TGS 26.360 FDAC, FDALC, FDHLC, FDHLC/M	08/2008 -	B 180 APC	B 180 EHD	B 185 APC	
TGS 26.360 FDAK, FDHLK	08/2008 -	B 180 APC	B 180 EHD	B 185 APC	
TGS 26.360 FDAS, FDHLS, FDHLS/M	08/2008 -	B 180 APC	B 180 EHD	B 185 APC	
TGS 26.360 FDC, FDRC, FDRC/M, FDLC, FNHLC	08/2008 -	B 180 APC	B 180 EHD	B 185 APC	
TGS 26.360 FDK, FDLK	08/2008 -	B 180 APC	B 180 EHD	B 185 APC	
TGS 26.360 FDS, FDRS, FDRS/M, FDLS, FNHLS	08/2008 -	B 180 APC	B 180 EHD	B 185 APC	
TGS 26.360 FD-TM	07/2008 -	B 180 APC	B 180 EHD	B 185 APC	
TGS 26.360 FNLC, FNLC, FNLLC, FNLLRC, FVLC	08/2008 -	B 180 APC	B 180 EHD	B 185 APC	
TGS 26.360 FNLLW	04/2008 -	B 180 APC	B 180 EHD	B 185 APC	
TGS 26.360 FNLS, FNLLS, FNLS, FPLS, FPLRS, FVLS	08/2008 -	B 180 APC	B 180 EHD	B 185 APC	
TGS 26.360 FPHLS	05/2008 -	B 180 APC	B 180 EHD	B 185 APC	
TGS 26.360 FVHLC	10/2007 -	B 180 APC	B 180 EHD	B 185 APC	
TGS 26.360 FVHLS	05/2008 -	B 180 APC	B 180 EHD	B 185 APC	
TGS 26.400 FDAC, FDALC	02/2009 -	B 180 APC	B 180 EHD	B 185 APC	
TGS 26.400 FDAK, FDALK	02/2009 -	B 180 APC	B 180 EHD	B 185 APC	
TGS 26.400 FDAS, FDALS	02/2009 -	B 180 APC	B 180 EHD	B 185 APC	
TGS 26.400 FDC, FDRC, FDC/M, FDLC, FDLC/M, FDLRC, FDLRC/M	02/2009 -	B 180 APC	B 180 EHD	B 185 APC	
TGS 26.400 FDK, FDLK	02/2009 -	B 180 APC	B 180 EHD	B 185 APC	
TGS 26.400 FDS, FDS/M, FDLS, FDLS/M	02/2009 -	B 180 APC	B 180 EHD	B 185 APC	
TGS 26.400 FD-TM	07/2008 -	B 180 APC	B 180 EHD	B 185 APC	
TGS 26.400 FNLC, FNLC, FNLLC, FNLLRC, FVLC, FNLLW	02/2009 -	B 180 APC	B 180 EHD	B 185 APC	
TGS 26.400 FNLS, FNLS, FNLLS, FNLLRS	02/2009 -	B 180 APC	B 180 EHD	B 185 APC	
TGS 26.400 FPHLS	05/2008 -	B 180 APC	B 180 EHD	B 185 APC	
TGS 26.400 FVHLC	10/2007 -	B 180 APC	B 180 EHD	B 185 APC	
TGS 26.400 FVHLS	05/2008 -	B 180 APC	B 180 EHD	B 185 APC	
TGS 26.440 FDAC, FDALC	02/2009 -	B 180 APC	B 180 EHD	B 185 APC	
TGS 26.440 FDAK, FDALK, FDHLK	02/2009 -	B 180 APC	B 180 EHD	B 185 APC	
TGS 26.440 FDAS, FDALS	02/2009 -	B 180 APC	B 180 EHD	B 185 APC	
TGS 26.440 FDC, FDRC, FDC/M, FDLC, FDLC/M, FNHLC	02/2009 -	B 180 APC	B 180 EHD	B 185 APC	
TGS 26.440 FDK, FDLK	02/2009 -	B 180 APC	B 180 EHD	B 185 APC	

MARCHIO E MODELLO - <i>MAKE AND MODEL</i> MARQUE ET MODÈLE - <i>MARKE UND MODELL</i> MARCA Y MODELO - <i>МАРКА И МОДЕЛЬ</i>	Periodo <i>Period</i>	powerCUBE		energyCUBE	
		APC	EHD	APC	RST
MAN <small>cont.</small>					
TGS 26.440 FDS, FDRS, FDS/M, FDLS, FDLRS	02/2009 -	B 180 APC	B 180 EHD	B 185 APC	
TGS 26.440 FD-TM	07/2008 -	B 180 APC	B 180 EHD	B 185 APC	
TGS 26.440 FNLC, FNLLC, FNLLW, FVLC	02/2009 -	B 180 APC	B 180 EHD	B 185 APC	
TGS 26.440 FNLS, FNLLS, FPLS, FVLS	02/2009 -	B 180 APC	B 180 EHD	B 185 APC	
TGS 26.440 FPHLS	05/2008 -	B 180 APC	B 180 EHD	B 185 APC	
TGS 26.440 FVHLC	10/2007 -	B 180 APC	B 180 EHD	B 185 APC	
TGS 26.440 FVHLS	05/2008 -	B 180 APC	B 180 EHD	B 185 APC	
TGS 26.480 FDAK, FDALK, FDHLK	02/2009 -	B 180 APC	B 180 EHD	B 185 APC	
TGS 26.480 FDAS, FDALS, FDHLS	02/2009 -	B 180 APC	B 180 EHD	B 185 APC	
TGS 26.480 FDC, FDC/M, FDLC, FDLC/M, FDRC, FDRC/M, FNLHC	02/2009 -	B 180 APC	B 180 EHD	B 185 APC	
TGS 26.480 FDK, FDLK	02/2009 -	B 180 APC	B 180 EHD	B 185 APC	
TGS 26.480 FDS, FDS/M, FDLS, FDLS/M, FDRS, FDRS/M	02/2009 -	B 180 APC	B 180 EHD	B 185 APC	
TGS 26.480 FNLC, FNLLC, FNLLRC, FNLLW, FVLC	02/2009 -	B 180 APC	B 180 EHD	B 185 APC	
TGS 26.480 FNLS, FNLLS	02/2009 -	B 180 APC	B 180 EHD	B 185 APC	
TGS 26.480 FPHLS	05/2008 -	B 180 APC	B 180 EHD	B 185 APC	
TGS 26.480 FVHLC	10/2007 -	B 180 APC	B 180 EHD	B 185 APC	
TGS 26.480 FVHLS	05/2008 -	B 180 APC	B 180 EHD	B 185 APC	
TGS 26.540 FDAC, FDALC, FDHLC, FDHLC/M	02/2009 -	B 180 APC	B 180 EHD	B 185 APC	
TGS 26.540 FDAK, FDALK, FDHLK	02/2009 -	B 180 APC	B 180 EHD	B 185 APC	
TGS 26.540 FDAS, FDALS, FDHLS	02/2009 -	B 180 APC	B 180 EHD	B 185 APC	
TGS 26.540 FDC, FDC/M, FDLC, FDLC/M, FDLRC, FDLRC/M,	02/2009 -	B 180 APC	B 180 EHD	B 185 APC	
TGS 26.540 FDK, FDLK	02/2009 -	B 180 APC	B 180 EHD	B 185 APC	
TGS 26.540 FDS, FDS/M, FDLS, FDLRS, FDLS/M	02/2009 -	B 180 APC	B 180 EHD	B 185 APC	
TGS 26.540 FNLC, FNLCR, FNLLC, FNLLRC, FNLLW, FVLC	02/2009 -	B 180 APC	B 180 EHD	B 185 APC	
TGS 26.540 FNLS, FNLLS, FVLS	02/2009 -	B 180 APC	B 180 EHD	B 185 APC	
TGS 28.320 FNHLC	07/2008 -	B 180 APC	B 180 EHD	B 185 APC	
TGS 28.320 FNLC	07/2008 -	B 180 APC	B 180 EHD	B 185 APC	
TGS 28.320 FNLS	07/2008 -	B 180 APC	B 180 EHD	B 185 APC	
TGS 28.360 FANLC	08/2008 -	B 180 APC	B 180 EHD	B 185 APC	
TGS 28.360 FANLK	08/2008 -	B 180 APC	B 180 EHD	B 185 APC	
TGS 28.360 FNLC	08/2008 -	B 180 APC	B 180 EHD	B 185 APC	
TGS 28.360 FNLS	08/2008 -	B 180 APC	B 180 EHD	B 185 APC	
TGS 28.400 FANLC	08/2008 -	B 180 APC	B 180 EHD	B 185 APC	
TGS 28.400 FANLK	08/2008 -	B 180 APC	B 180 EHD	B 185 APC	
TGS 28.400 FNLC	08/2008 -	B 180 APC	B 180 EHD	B 185 APC	
TGS 28.400 FNLS	08/2008 -	B 180 APC	B 180 EHD	B 185 APC	
TGS 28.440 FANLC	08/2008 -	B 180 APC	B 180 EHD	B 185 APC	
TGS 28.440 FANLK	08/2008 -	B 180 APC	B 180 EHD	B 185 APC	
TGS 28.440 FNLC	08/2008 -	B 180 APC	B 180 EHD	B 185 APC	
TGS 28.440 FNLS	08/2008 -	B 180 APC	B 180 EHD	B 185 APC	
TGS 28.480 FANLC	08/2008 -	B 180 APC	B 180 EHD	B 185 APC	
TGS 28.480 FANLK	08/2008 -	B 180 APC	B 180 EHD	B 185 APC	
TGS 28.480 FNLC	08/2008 -	B 180 APC	B 180 EHD	B 185 APC	
TGS 28.480 FNLS	08/2008 -	B 180 APC	B 180 EHD	B 185 APC	
TGS 28.540 FNHLC	06/2008 -	B 180 APC	B 180 EHD	B 185 APC	

MARCHIO E MODELLO - MAKE AND MODEL MARQUE ET MODÈLE - MARKE UND MODELL MARCA Y MODELO - МАРКА И МОДЕЛЬ	Periodo Period	powerCUBE		energyCUBE	
		APC	EHD	APC	RST
MAN					
<i>cont.</i>					
TGS 28.540 FNLC	02/2009 -	B 180 APC	B 180 EHD	B 185 APC	
TGS 28.540 FNLS	02/2009 -	B 180 APC	B 180 EHD	B 185 APC	
TGS 32.320 FFD-TM	02/2009 -	B 180 APC	B 180 EHD	B 185 APC	
TGS 32.360 FFDRC	08/2008 -	B 180 APC	B 180 EHD	B 185 APC	
TGS 32.360 FFD-TM, FFDRC-TM	10/2007 -	B 180 APC	B 180 EHD	B 185 APC	
TGS 32.400 FFDRC	08/2008 -	B 180 APC	B 180 EHD	B 185 APC	
TGS 32.400 FFD-TM, FFDRC-TM	10/2007 -	B 180 APC	B 180 EHD	B 185 APC	
TGS 32.440 FFDRC	08/2008 -	B 180 APC	B 180 EHD	B 185 APC	
TGS 32.440 FFD-TM, FFDRC-TM	10/2007 -	B 180 APC	B 180 EHD	B 185 APC	
TGS 32.480 FFD-TM	08/2008 -	B 180 APC	B 180 EHD	B 185 APC	
TGS 33.360 FDAC, FDALC	06/2008 -	B 180 APC	B 180 EHD	B 185 APC	
TGS 33.360 FDAK, FDALK	02/2009 -	B 180 APC	B 180 EHD	B 185 APC	
TGS 33.360 FDAS, FDALS	06/2008 -	B 180 APC	B 180 EHD	B 185 APC	
TGS 33.360 FDC, FDLC	06/2008 -	B 180 APC	B 180 EHD	B 185 APC	
TGS 33.360 FDK, FDLK	02/2009 -	B 180 APC	B 180 EHD	B 185 APC	
TGS 33.360 FDS, FDLS	02/2009 -	B 180 APC	B 180 EHD	B 185 APC	
TGS 33.400 FDAC, FDALC	07/2008 -	B 180 APC	B 180 EHD	B 185 APC	
TGS 33.400 FDAK, FDALK	07/2008 -	B 180 APC	B 180 EHD	B 185 APC	
TGS 33.400 FDAS, FDALS	07/2008 -	B 180 APC	B 180 EHD	B 185 APC	
TGS 33.400 FDC, FDLC	06/2008 -	B 180 APC	B 180 EHD	B 185 APC	
TGS 33.400 FDK, FDLK	07/2008 -	B 180 APC	B 180 EHD	B 185 APC	
TGS 33.400 FDS, FDLS	02/2009 -	B 180 APC	B 180 EHD	B 185 APC	
TGS 33.440 FDAC, FDALC	07/2008 -	B 180 APC	B 180 EHD	B 185 APC	
TGS 33.440 FDAK, FDALK	07/2008 -	B 180 APC	B 180 EHD	B 185 APC	
TGS 33.440 FDAS, FDALS	06/2008 -	B 180 APC	B 180 EHD	B 185 APC	
TGS 33.440 FDC, FDLC	06/2008 -	B 180 APC	B 180 EHD	B 185 APC	
TGS 33.440 FDK, FDLK	06/2008 -	B 180 APC	B 180 EHD	B 185 APC	
TGS 33.440 FDS, FDLS	06/2008 -	B 180 APC	B 180 EHD	B 185 APC	
TGS 33.480 FDAC, FDALC	08/2008 -	B 180 APC	B 180 EHD	B 185 APC	
TGS 33.480 FDAK, FDALK	08/2008 -	B 180 APC	B 180 EHD	B 185 APC	
TGS 33.480 FDAS, FDALS	08/2008 -	B 180 APC	B 180 EHD	B 185 APC	
TGS 33.480 FDC, FDC/M, FDLC, FDLC/M	08/2008 -	B 180 APC	B 180 EHD	B 185 APC	
TGS 33.480 FDK, FDLK	08/2008 -	B 180 APC	B 180 EHD	B 185 APC	
TGS 33.480 FDS, FDLS, FDLS/M	08/2008 -	B 180 APC	B 180 EHD	B 185 APC	
TGS 33.540 FDAC, FDALC	02/2009 -	B 180 APC	B 180 EHD	B 185 APC	
TGS 33.540 FDAK, FDALK	02/2009 -	B 180 APC	B 180 EHD	B 185 APC	
TGS 33.540 FDAS, FDALS	02/2009 -	B 180 APC	B 180 EHD	B 185 APC	
TGS 33.540 FDC, FDLC	02/2009 -	B 180 APC	B 180 EHD	B 185 APC	
TGS 33.540 FDK, FDLK	02/2009 -	B 180 APC	B 180 EHD	B 185 APC	
TGS 33.540 FDS, FDLS	02/2009 -	B 180 APC	B 180 EHD	B 185 APC	
TGS 35.320 FFDAK	06/2008 -	B 180 APC	B 180 EHD	B 185 APC	
TGS 35.320 FFDHLC	06/2008 -	B 180 APC	B 180 EHD	B 185 APC	
TGS 35.320 FFDLC, FFDLC, FDNLC	06/2008 -	B 180 APC	B 180 EHD	B 185 APC	
TGS 35.320 FFDK, FFDLK	08/2008 -	B 180 APC	B 180 EHD	B 185 APC	
TGS 35.320 FFD-TM	10/2007 -	B 180 APC	B 180 EHD	B 185 APC	

MARCHIO E MODELLO - MAKE AND MODEL MARQUE ET MODÈLE - MARKE UND MODELL MARCA Y MODELO - МАРКА И МОДЕЛЬ	Periodo Period	powerCUBE		energyCUBE	
		APC	EHD	APC	RST
MAN					
<i>cont.</i>					
TGS 35.320 FFNLC	01/2009 -	B 180 APC	B 180 EHD	B 185 APC	
TGS 35.360 FFDK	06/2008 -	B 180 APC	B 180 EHD	B 185 APC	
TGS 35.360 FFDC, FFDLC, FDNLC	06/2008 -	B 180 APC	B 180 EHD	B 185 APC	
TGS 35.360 FFDK, FFDLK, FFDK	08/2008 -	B 180 APC	B 180 EHD	B 185 APC	
TGS 35.360 FFD-TM	10/2007 -	B 180 APC	B 180 EHD	B 185 APC	
TGS 35.360 FFNLC	06/2008 -	B 180 APC	B 180 EHD	B 185 APC	
TGS 35.400 FFDK	06/2008 -	B 180 APC	B 180 EHD	B 185 APC	
TGS 35.400 FFDK, FFDHLK	06/2008 -	B 180 APC	B 180 EHD	B 185 APC	
TGS 35.400 FFDC, FDNLC	06/2008 -	B 180 APC	B 180 EHD	B 185 APC	
TGS 35.400 FFDK, FFDLK, FFDK	08/2008 -	B 180 APC	B 180 EHD	B 185 APC	
TGS 35.400 FFD-TM	10/2007 -	B 180 APC	B 180 EHD	B 185 APC	
TGS 35.400 FFNHLK	10/2007 -	B 180 APC	B 180 EHD	B 185 APC	
TGS 35.400 FFNLC	06/2008 -	B 180 APC	B 180 EHD	B 185 APC	
TGS 35.440 FDNLC, FFDC, FFNLC	06/2008 -	B 180 APC	B 180 EHD	B 185 APC	
TGS 35.440 FFDK	06/2008 -	B 180 APC	B 180 EHD	B 185 APC	
TGS 35.440 FFDK, FFDHLK	06/2008 -	B 180 APC	B 180 EHD	B 185 APC	
TGS 35.440 FFDK, FFDLK, FFDK	08/2008 -	B 180 APC	B 180 EHD	B 185 APC	
TGS 35.440 FFD-TM	10/2007 -	B 180 APC	B 180 EHD	B 185 APC	
TGS 35.440 FFNHLK	10/2007 -	B 180 APC	B 180 EHD	B 185 APC	
TGS 35.440 FFNLC	06/2008 -	B 180 APC	B 180 EHD	B 185 APC	
TGS 35.480 FDNLC, FFDC, FFDLC	06/2008 -	B 180 APC	B 180 EHD	B 185 APC	
TGS 35.480 FFDK	06/2008 -	B 180 APC	B 180 EHD	B 185 APC	
TGS 35.480 FFDK, FFDHLK	06/2008 -	B 180 APC	B 180 EHD	B 185 APC	
TGS 35.480 FFDK, FFDLK, FFDK	08/2008 -	B 180 APC	B 180 EHD	B 185 APC	
TGS 35.480 FFD-TM	10/2007 -	B 180 APC	B 180 EHD	B 185 APC	
TGS 35.480 FFNHLK	10/2007 -	B 180 APC	B 180 EHD	B 185 APC	
TGS 35.480 FFNLC	06/2008 -	B 180 APC	B 180 EHD	B 185 APC	
TGS 35.540 FDNLC, FFDC, FFDLC	06/2008 -	B 180 APC	B 180 EHD	B 185 APC	
TGS 35.540 FFDK	02/2009 -	B 180 APC	B 180 EHD	B 185 APC	
TGS 35.540 FFDK, FFDHLK	02/2009 -	B 180 APC	B 180 EHD	B 185 APC	
TGS 35.540 FFDK, FFDLK, FFDK	02/2009 -	B 180 APC	B 180 EHD	B 185 APC	
TGS 35.540 FFD-TM	10/2007 -	B 180 APC	B 180 EHD	B 185 APC	
TGS 35.540 FFNLC	02/2009 -	B 180 APC	B 180 EHD	B 185 APC	
TGS 37.320 FFDC	07/2008 -	B 180 APC	B 180 EHD	B 185 APC	
TGS 37.320 FFDK	07/2008 -	B 180 APC	B 180 EHD	B 185 APC	
TGS 37.320 FFD-TM	10/2007 -	B 180 APC	B 180 EHD	B 185 APC	
TGS 37.360 FFDC	07/2008 -	B 180 APC	B 180 EHD	B 185 APC	
TGS 37.360 FFDK	07/2008 -	B 180 APC	B 180 EHD	B 185 APC	
TGS 37.360 FFD-TM	10/2007 -	B 180 APC	B 180 EHD	B 185 APC	
TGS 37.400 FFDC	07/2008 -	B 180 APC	B 180 EHD	B 185 APC	
TGS 37.400 FFDK	07/2008 -	B 180 APC	B 180 EHD	B 185 APC	
TGS 37.400 FFD-TM	10/2007 -	B 180 APC	B 180 EHD	B 185 APC	
TGS 37.440 FFDC	07/2008 -	B 180 APC	B 180 EHD	B 185 APC	
TGS 37.440 FFDK	07/2008 -	B 180 APC	B 180 EHD	B 185 APC	
TGS 37.440 FFD-TM	10/2007 -	B 180 APC	B 180 EHD	B 185 APC	

MARCHIO E MODELLO - MAKE AND MODEL MARQUE ET MODÈLE - MARKE UND MODELL MARCA Y MODELO - МАРКА И МОДЕЛЬ	Periodo Period	powerCUBE		energyCUBE	
		APC	EHD	APC	RST
MAN cont.					
TGS 37.480 FFDC	07/2008 -	B 180 APC	B 180 EHD	B 185 APC	
TGS 37.480 FFDK	07/2008 -	B 180 APC	B 180 EHD	B 185 APC	
TGS 37.480 FFD-TM	10/2007 -	B 180 APC	B 180 EHD	B 185 APC	
TGS 37.540 FFDC	02/2009 -	B 180 APC	B 180 EHD	B 185 APC	
TGS 37.540 FFDK	02/2009 -	B 180 APC	B 180 EHD	B 185 APC	
TGS 37.540 FFD-TM	10/2007 -	B 180 APC	B 180 EHD	B 185 APC	
TGS 40.400	02/2011 -	B 180 APC		B 185 APC	
TGS 40.400 FDAK-WW, FDARK-WW	02/2011 -	B 180 APC		B 185 APC	
TGS 40.440	02/2011 -	B 180 APC		B 185 APC	
TGS 40.440 FDAK-WW, FDARK-WW	02/2011 -	B 180 APC		B 185 APC	
TGS 40.440 FDAS-WW, FDARS-WW	02/2011 -	B 180 APC		B 185 APC	
TGS 41.320 FFDK	06/2008 -	B 180 APC	B 180 EHD	B 185 APC	
TGS 41.360 FFDC	07/2008 -	B 180 APC	B 180 EHD	B 185 APC	
TGS 41.360 FFDK	07/2008 -	B 180 APC	B 180 EHD	B 185 APC	
TGS 41.360 FFD-TM	10/2007 -	B 180 APC	B 180 EHD	B 185 APC	
TGS 41.400 FFDC	07/2008 -	B 180 APC	B 180 EHD	B 185 APC	
TGS 41.400 FFDK	07/2008 -	B 180 APC	B 180 EHD	B 185 APC	
TGS 41.400 FFD-TM	10/2007 -	B 180 APC	B 180 EHD	B 185 APC	
TGS 41.440 FFDK	06/2008 -	B 180 APC	B 180 EHD	B 185 APC	
TGS 41.440 FFDC	07/2008 -	B 180 APC	B 180 EHD	B 185 APC	
TGS 41.440 FFDK	07/2008 -	B 180 APC	B 180 EHD	B 185 APC	
TGS 41.440 FFD-TM	10/2007 -	B 180 APC	B 180 EHD	B 185 APC	
TGS 41.480 FFDK	06/2008 -	B 180 APC	B 180 EHD	B 185 APC	
TGS 41.480 FFDC	07/2008 -	B 180 APC	B 180 EHD	B 185 APC	
TGS 41.480 FFDK	07/2008 -	B 180 APC	B 180 EHD	B 185 APC	
TGS 41.480 FFD-TM	10/2007 -	B 180 APC	B 180 EHD	B 185 APC	
TGS 41.540 FFDK	02/2009 -	B 180 APC	B 180 EHD	B 185 APC	
TGS 41.540 FFDC	02/2009 -	B 180 APC	B 180 EHD	B 185 APC	
TGS 41.540 FFDK	02/2009 -	B 180 APC	B 180 EHD	B 185 APC	
TGS 41.540 FFD-TM	10/2007 -	B 180 APC	B 180 EHD	B 185 APC	
TGX 18.360 FHLC	10/2007 -	B 180 APC	B 180 EHD	B 185 APC	
TGX 18.360 FHLS, FHLS/M	10/2007 -	B 180 APC	B 180 EHD	B 185 APC	
TGX 18.360 FLC, FLRC, FLLC, FLLRC, FLLW, FLLW/N	10/2007 -	B 180 APC	B 180 EHD	B 185 APC	
TGX 18.360 FLS, FLS/M, FLRS, FLRS/N, FLLS, FLLS/N, FLLRS, FLLRS/N	10/2007 -	B 180 APC	B 180 EHD	B 185 APC	
TGX 18.400 FHLC	10/2007 -	B 180 APC	B 180 EHD	B 185 APC	
TGX 18.400 FHLS, FHLS/M	10/2007 -	B 180 APC	B 180 EHD	B 185 APC	
TGX 18.400 FLC, FLRC, FLLC, FLLRC, FLLW, FLLW/N	10/2007 -	B 180 APC	B 180 EHD	B 185 APC	
TGX 18.400 FLS, FLS/M, FLRS, FLRS/N, FLLS, FLLS/N, FLLRS, FLLRS/N	10/2007 -	B 180 APC	B 180 EHD	B 185 APC	
TGX 18.440 FHLC	10/2007 -	B 180 APC	B 180 EHD	B 185 APC	
TGX 18.440 FHLS, FHLS/M	10/2007 -	B 180 APC	B 180 EHD	B 185 APC	
TGX 18.440 FHLS, FHLS/M	10/2012 -	B 180 APC		B 185 APC	
TGX 18.440 FLC, FLRC, FLLC, FLLRC, FLLW, FLLW/N	10/2007 -	B 180 APC	B 180 EHD	B 185 APC	
TGX 18.440 FLRC	10/2007 -	B 180 APC	B 180 EHD	B 185 APC	
TGX 18.440 FLRS	10/2007 -	B 180 APC	B 180 EHD	B 185 APC	
TGX 18.440 FLS, FLS/M, FLRS, FLRS/M, FLLS, FLLS/N, FLLRS, FLLRS/	10/2007 -	B 180 APC	B 180 EHD	B 185 APC	

MARCHIO E MODELLO - <i>MAKE AND MODEL</i> MARQUE ET MODÈLE - <i>MARKE UND MODELL</i> MARCA Y MODELO - <i>МАРКА И МОДЕЛЬ</i>	Periodo <i>Period</i>	powerCUBE		energyCUBE	
		APC	EHD	APC	RST
MAN <small>cont.</small>					
TGX 18.480 FHLC	10/2007 -	B 180 APC	B 180 EHD	B 185 APC	
TGX 18.480 FHLS, FHLS/M	10/2007 -	B 180 APC	B 180 EHD	B 185 APC	
TGX 18.480 FLC, FLRC, FLLC, FLLRC, FLLW, FLLW/N	10/2007 -	B 180 APC	B 180 EHD	B 185 APC	
TGX 18.480 FLS, FLS/M, FLRS, FLRS/N, FLLS, FLLS/N, FLLRS, FLLRS/N	10/2007 -	B 180 APC	B 180 EHD	B 185 APC	
TGX 18.540 FHLC	10/2007 -	B 180 APC	B 180 EHD	B 185 APC	
TGX 18.540 FHLS, FHLS/M	10/2007 -	B 180 APC	B 180 EHD	B 185 APC	
TGX 18.540 FLC, FLRC, FLLC, FLLRC, FLLW, FLLW/N	10/2007 -	B 180 APC	B 180 EHD	B 185 APC	
TGX 18.540 FLS, FLS/M, FLRS, FLRS/N, FLLS, FLLS/N, FLLRS, FLLRS/N	10/2007 -	B 180 APC	B 180 EHD	B 185 APC	
TGX 18.680 FLS	10/2007 -	B 180 APC	B 180 EHD	B 185 APC	
TGX 24.360 FNLLW/N	10/2007 -	B 180 APC	B 180 EHD	B 185 APC	
TGX 24.360 FPLS, FPLRS	10/2007 -	B 180 APC	B 180 EHD	B 185 APC	
TGX 24.400 FNLLW/N	10/2007 -	B 180 APC	B 180 EHD	B 185 APC	
TGX 24.400 FPLS, FPLRS	10/2007 -	B 180 APC	B 180 EHD	B 185 APC	
TGX 24.440 FNLLW/N	10/2007 -	B 180 APC	B 180 EHD	B 185 APC	
TGX 24.440 FPLRS	10/2007 -	B 180 APC	B 180 EHD	B 185 APC	
TGX 24.440 FPLS, FPLRS	10/2007 -	B 180 APC	B 180 EHD	B 185 APC	
TGX 24.480 FNLLW/N	10/2007 -	B 180 APC	B 180 EHD	B 185 APC	
TGX 24.480 FPLS, FPLRS	10/2007 -	B 180 APC	B 180 EHD	B 185 APC	
TGX 24.540 FNLLW/N	02/2009 -	B 180 APC	B 180 EHD	B 185 APC	
TGX 24.540 FPLS, FPLRS	10/2007 -	B 180 APC	B 180 EHD	B 185 APC	
TGX 26.320 FNLS, FNLLS	10/2007 -	B 180 APC	B 180 EHD	B 185 APC	
TGX 26.360 FDC, FDLC, FDRC, FDLRC	07/2008 -	B 180 APC	B 180 EHD	B 185 APC	
TGX 26.360 FDHLC	10/2007 -	B 180 APC	B 180 EHD	B 185 APC	
TGX 26.360 FDHLS	10/2007 -	B 180 APC	B 180 EHD	B 185 APC	
TGX 26.360 FDS, FDLS, FDRS, FDLRS	07/2008 -	B 180 APC	B 180 EHD	B 185 APC	
TGX 26.360 FNHLC	10/2007 -	B 180 APC	B 180 EHD	B 185 APC	
TGX 26.360 FNHLS	12/2007 -	B 180 APC	B 180 EHD	B 185 APC	
TGX 26.360 FNLC, FNLCR, FNLLC, FNLLRC, FNLLW	10/2007 -	B 180 APC	B 180 EHD	B 185 APC	
TGX 26.360 FNLS, FNLLS, FNLRs, FNLLRS, FPLS, FPLRS, FVLS	10/2007 -	B 180 APC	B 180 EHD	B 185 APC	
TGX 26.360 FVHLS	05/2008 -	B 180 APC	B 180 EHD	B 185 APC	
TGX 26.400 FDC, FDLC, FDRC, FDLRC	07/2008 -	B 180 APC	B 180 EHD	B 185 APC	
TGX 26.400 FDHLC	10/2007 -	B 180 APC	B 180 EHD	B 185 APC	
TGX 26.400 FDHLS	10/2007 -	B 180 APC	B 180 EHD	B 185 APC	
TGX 26.400 FDS, FDLS, FDRS, FDLRS	07/2008 -	B 180 APC	B 180 EHD	B 185 APC	
TGX 26.400 FNHLC	12/2007 -	B 180 APC	B 180 EHD	B 185 APC	
TGX 26.400 FNHLS	12/2007 -	B 180 APC	B 180 EHD	B 185 APC	
TGX 26.400 FNLC, FNLCR, FNLLC, FNLLRC, FNLLW	10/2007 -	B 180 APC	B 180 EHD	B 185 APC	
TGX 26.400 FNLS, FNLLS, FNLRs, FNLLRS, FPLS, FPLRS, FVLS	10/2007 -	B 180 APC	B 180 EHD	B 185 APC	
TGX 26.400 FPMLS	05/2008 -	B 180 APC	B 180 EHD	B 185 APC	
TGX 26.400 FVHLS	05/2008 -	B 180 APC	B 180 EHD	B 185 APC	
TGX 26.440 FDC, FDC/M, FDLC, FDRC, FDRC/M, FDLRC	10/2012 -	B 180 APC		B 185 APC	
TGX 26.440 FDC, FDLC, FDRC, FDLRC	07/2008 -	B 180 APC	B 180 EHD	B 185 APC	
TGX 26.440 FDHLC	09/2007 -	B 180 APC	B 180 EHD	B 185 APC	
TGX 26.440 FDHLS	10/2007 -	B 180 APC	B 180 EHD	B 185 APC	
TGX 26.440 FDS, FDLS, FDRS, FDLRS	07/2008 -	B 180 APC	B 180 EHD	B 185 APC	

MARCHIO E MODELLO - MAKE AND MODEL MARQUE ET MODÈLE - MARKE UND MODELL MARCA Y MODELO - МАРКА И МОДЕЛЬ	Periodo Period	powerCUBE		energyCUBE	
		APC	EHD	APC	RST
MAN <small>cont.</small>					
TGX 26.440 FDS, FDS/M, FDLS, FDLS/M, FDRS, FDRS/M, FDLRS	10/2012 -	B 180 APC	B 180 EHD	B 185 APC	
TGX 26.440 FNHLC	12/2007 -	B 180 APC	B 180 EHD	B 185 APC	
TGX 26.440 FNHLS	12/2007 -	B 180 APC	B 180 EHD	B 185 APC	
TGX 26.440 FNLC, FNLC, FNLLC, FNLLRC, FNLLW	10/2007 -	B 180 APC	B 180 EHD	B 185 APC	
TGX 26.440 FNLC, FNLC, FNLLC, FNLLRC, FNLLW	10/2012 -	B 180 APC		B 185 APC	
TGX 26.440 FNLS, FNLLS, FNLLRS, FNLLRS, FPLS, FPLRS, FVLS	10/2007 -	B 180 APC	B 180 EHD	B 185 APC	
TGX 26.440 FNLS, FNLLS, FNLLRS, FNLLRS, FPLS, FPLRS, FVLS	10/2012 -	B 180 APC	B 180 EHD	B 185 APC	
TGX 26.440 FPHLS	05/2008 -	B 180 APC	B 180 EHD	B 185 APC	
TGX 26.440 FPLRS	07/2008 -	B 180 APC	B 180 EHD	B 185 APC	
TGX 26.440 FVHLS	05/2008 -	B 180 APC	B 180 EHD	B 185 APC	
TGX 26.480 FDC, FDLC, FDRC, FDLRC	07/2008 -	B 180 APC	B 180 EHD	B 185 APC	
TGX 26.480 FDHLC	09/2007 -	B 180 APC	B 180 EHD	B 185 APC	
TGX 26.480 FDHLS	10/2007 -	B 180 APC	B 180 EHD	B 185 APC	
TGX 26.480 FDS, FDLS, FDRS, FDLRS	07/2008 -	B 180 APC	B 180 EHD	B 185 APC	
TGX 26.480 FNHLC	12/2007 -	B 180 APC	B 180 EHD	B 185 APC	
TGX 26.480 FNHLS	12/2007 -	B 180 APC	B 180 EHD	B 185 APC	
TGX 26.480 FNLC, FNLC, FNLLC, FNLLRC, FNLLW	10/2007 -	B 180 APC	B 180 EHD	B 185 APC	
TGX 26.480 FNLS, FNLLS, FNLLRS, FNLLRS, FPLS, FPLRS, FVLS	10/2007 -	B 180 APC	B 180 EHD	B 185 APC	
TGX 26.480 FPHLS	05/2008 -	B 180 APC	B 180 EHD	B 185 APC	
TGX 26.480 FVHLS	05/2008 -	B 180 APC	B 180 EHD	B 185 APC	
TGX 26.540 FDC, FDLC, FDRC, FDLRC	02/2009 -	B 180 APC	B 180 EHD	B 185 APC	
TGX 26.540 FDS, FDLS, FDRS, FDLRS	02/2009 -	B 180 APC	B 180 EHD / B 160 EHD	B 185 APC	
TGX 26.540 FNLC, FNLC, FNLLC, FNLLRC, FNLLW	10/2007 -	B 180 APC	B 180 EHD	B 185 APC	
TGX 26.540 FNLS, FNLLS, FNLLRS, FNLLRS, FPLS, FPLRS, FVLS	10/2007 -	B 180 APC	B 180 EHD	B 185 APC	
TGX 28.360 FNLC	10/2007 -	B 180 APC	B 180 EHD	B 185 APC	
TGX 28.360 FNLS	10/2007 -	B 180 APC	B 180 EHD	B 185 APC	
TGX 28.400 FNLC	10/2007 -	B 180 APC	B 180 EHD	B 185 APC	
TGX 28.400 FNLS	10/2007 -	B 180 APC	B 180 EHD	B 185 APC	
TGX 28.440 FDS	10/2012 -	B 180 APC	B 180 EHD	B 185 APC	
TGX 28.440 FNLC	10/2007 -	B 180 APC	B 180 EHD	B 185 APC	
TGX 28.440 FNLC	10/2012 -	B 180 APC	B 180 EHD	B 185 APC	
TGX 28.440 FNLS	10/2007 -	B 180 APC	B 180 EHD	B 185 APC	
TGX 28.440 FNLS	10/2012 -	B 180 APC	B 180 EHD	B 185 APC	
TGX 28.480 FNLC	10/2007 -	B 180 APC	B 180 EHD	B 185 APC	
TGX 28.480 FNLS	10/2007 -	B 180 APC	B 180 EHD	B 185 APC	
TGX 28.540 FNLC	10/2007 -	B 180 APC	B 180 EHD	B 185 APC	
TGX 28.540 FNLS	02/2009 -	B 180 APC	B 180 EHD	B 185 APC	
TGX 32.360 FDC, FDC/M, FDLC	10/2007 -	B 180 APC	B 180 EHD	B 185 APC	
TGX 32.360 FDS, FDS/M, FDLS, FDLS/M	10/2007 -	B 180 APC	B 180 EHD	B 185 APC	
TGX 33.400 FDC, FDC/M, FDLC	10/2007 -	B 180 APC	B 180 EHD	B 185 APC	
TGX 33.400 FDS, FDS/M, FDLS, FDLS/M	10/2007 -	B 180 APC	B 180 EHD	B 185 APC	
TGX 33.440 FDC, FDC/M, FDLC	10/2007 -	B 180 APC	B 180 EHD	B 185 APC	
TGX 33.440 FDC, FDC/M, FDLC	10/2012 -	B 180 APC	B 180 EHD / B 160 EHD	B 185 APC	
TGX 33.440 FDS, FDS/M, FDLS, FDLS/M	10/2007 -	B 180 APC	B 180 EHD	B 185 APC	
TGX 33.440 FDS, FDS/M, FDLS, FDLS/M	10/2012 -	B 180 APC	B 180 EHD / B 160 EHD	B 185 APC	

MARCHIO E MODELLO - MAKE AND MODEL MARQUE ET MODÈLE - MARKE UND MODELL MARCA Y MODELO - МАРКА И МОДЕЛЬ	Periodo Period	powerCUBE		energyCUBE	
		APC	EHD	APC	RST
MAN					
<i>cont.</i>					
TGX 33.480 FDC, FDC/M, FDLC	10/2007 -	B 180 APC	B 180 EHD	B 185 APC	
TGX 33.480 FDS, FDS/M, FDLS, FDLS/M	10/2007 -	B 180 APC	B 180 EHD	B 185 APC	
TGX 33.540 FDC, FDC/M, FDLC	10/2007 -	B 180 APC	B 180 EHD	B 185 APC	
TGX 33.540 FDS, FDS/M, FDLS, FDLS/M	10/2007 -	B 180 APC	B 180 EHD	B 185 APC	
TGX 33.680 FDLC	10/2007 -	B 180 APC	B 180 EHD	B 185 APC	
TGX 33.680 FDLS	10/2007 -	B 180 APC	B 180 EHD	B 185 APC	
TGX 35.360 FDNLC	06/2008 -	B 180 APC	B 180 EHD	B 185 APC	
TGX 35.400 FDNLC	06/2008 -	B 180 APC	B 180 EHD	B 185 APC	
TGX 35.440 FDNLC	06/2008 -	B 180 APC	B 180 EHD	B 185 APC	
TGX 35.480 FDNLC	06/2008 -	B 180 APC	B 180 EHD	B 185 APC	
TGX 35.540 FDNLC	06/2008 -	B 180 APC	B 180 EHD	B 185 APC	
TGX 41.540 FVDS, FVDLS	06/2008 -	B 180 APC	B 180 EHD	B 185 APC	
TGX 41.680 FVDS, FVDLS	10/2007 -	B 180 APC	B 180 EHD	B 185 APC	
ÜL ÜL 242	09/1989 - 03/1993	B 180 APC	B 180 EHD	B 185 APC	
ÜL ÜL 272	03/1993 -	B 180 APC	B 180 EHD	B 185 APC	
ÜL ÜL 292	09/1989 - 03/1993	B 180 APC	B 180 EHD	B 185 APC	
ÜL ÜL 312, ÜL 322	04/1992 - 09/1996	B 180 APC	B 180 EHD	B 185 APC	
ÜL ÜL 313	09/1996 -	B 180 APC	B 180 EHD	B 185 APC	
ÜL ÜL 353	06/1997 -	B 180 APC	B 180 EHD	B 185 APC	
MERCEDES-BENZ					
ACTROS 1831 AK	04/1997 - 10/2002	B 180 APC	B 180 EHD	B 185 APC	
ACTROS 1831 K	04/1997 - 10/2002	B 180 APC	B 180 EHD	B 185 APC	
ACTROS 1831 S, 1831 LS	09/1996 - 10/2002	B 180 APC	B 180 EHD	B 185 APC	
ACTROS 1835 AK	04/1997 - 10/2002	B 180 APC	B 180 EHD	B 185 APC	
ACTROS 1835 K	04/1997 - 10/2002	B 180 APC	B 180 EHD	B 185 APC	
ACTROS 1835 S, 1835 LS	09/1996 - 10/2002	B 180 APC	B 180 EHD	B 185 APC	
ACTROS 1835, 1835 L	09/1996 - 10/2002	B 180 APC	B 180 EHD	B 185 APC	
ACTROS 1840 AK	04/1997 - 10/2002	B 180 APC	B 180 EHD	B 185 APC	
ACTROS 1840 K	04/1997 - 10/2002	B 180 APC	B 180 EHD	B 185 APC	
ACTROS 1840 S, 1840 LS	09/1996 - 10/2002	B 180 APC	B 180 EHD	B 185 APC	
ACTROS 1840, 1840 L	09/1996 - 10/2002	B 180 APC	B 180 EHD	B 185 APC	
ACTROS 1843 AK	04/1997 - 10/2002	B 180 APC	B 180 EHD	B 185 APC	
ACTROS 1843 K	04/1997 - 10/2002	B 180 APC	B 180 EHD	B 185 APC	
ACTROS 1843 S, 1843 LS	09/1996 - 10/2002	B 180 APC	B 180 EHD	B 185 APC	
ACTROS 1843, 1843 L	09/1996 - 10/2002	B 180 APC	B 180 EHD	B 185 APC	
ACTROS 1846 AK	04/1997 - 10/2003	B 180 APC	B 180 EHD	B 185 APC	
ACTROS 1846 S, 1846 LS	10/1998 -	B 180 APC	B 180 EHD	B 185 APC	
ACTROS 1848 AK	04/1997 - 10/2002	B 180 APC	B 180 EHD	B 185 APC	
ACTROS 1848 K	04/1997 - 10/2002	B 180 APC	B 180 EHD	B 185 APC	
ACTROS 1848 S, 1848 LS	09/1996 - 10/2002	B 180 APC	B 180 EHD	B 185 APC	
ACTROS 1848, 1848 L	09/1996 - 10/2002	B 180 APC	B 180 EHD	B 185 APC	

MARCHIO E MODELLO - MAKE AND MODEL MARQUE ET MODÈLE - MARKE UND MODELL MARCA Y MODELO - МАРКА И МОДЕЛЬ	Periodo Period	powerCUBE		energyCUBE	
		APC	EHD	APC	RST
MERCEDES-BENZ cont.					
ACTROS 1850 AK	10/1997 -	B 180 APC	B 180 EHD	B 185 APC	
ACTROS 1853 S,1853 LS	09/1996 - 10/2002	B 180 APC	B 180 EHD	B 185 APC	
ACTROS 1853,1853 L	09/1996 - 10/2002	B 180 APC	B 180 EHD	B 185 APC	
ACTROS 1857 L	04/1997 - 10/2002	B 180 APC	B 180 EHD	B 185 APC	
ACTROS 1857 LS	04/1997 - 10/2002	B 180 APC	B 180 EHD	B 185 APC	
ACTROS 2031	04/1997 - 10/2002	B 180 APC	B 180 EHD	B 185 APC	
ACTROS 2031 A	04/1997 - 10/2002	B 180 APC	B 180 EHD	B 185 APC	
ACTROS 2031 AK	09/1996 - 10/2002	B 180 APC	B 180 EHD	B 185 APC	
ACTROS 2031 AS	04/1996 - 10/2002	B 180 APC	B 180 EHD	B 185 APC	
ACTROS 2031 K	04/1997 - 10/2002	B 180 APC	B 180 EHD	B 185 APC	
ACTROS 2031 S	04/1996 - 10/2002	B 180 APC	B 180 EHD	B 185 APC	
ACTROS 2035 A	04/1997 - 10/2002	B 180 APC	B 180 EHD	B 185 APC	
ACTROS 2035 S	04/1996 - 10/2002	B 180 APC	B 180 EHD	B 185 APC	
ACTROS 2040	09/1996 - 10/2002	B 180 APC	B 180 EHD	B 185 APC	
ACTROS 2040 AK	09/1996 - 10/2002	B 180 APC	B 180 EHD	B 185 APC	
ACTROS 2040 AS	04/1996 - 10/2002	B 180 APC	B 180 EHD	B 185 APC	
ACTROS 2040 S	04/1996 - 10/2002	B 180 APC	B 180 EHD	B 185 APC	
ACTROS 2043 AS	04/1996 - 10/2002	B 180 APC	B 180 EHD	B 185 APC	
ACTROS 2046 AS	10/1996 -	B 180 APC	B 180 EHD	B 185 APC	
ACTROS 2048 AS	04/1996 - 10/2002	B 180 APC	B 180 EHD	B 185 APC	
ACTROS 2050 AS	10/1996 -	B 180 APC	B 180 EHD	B 185 APC	
ACTROS 2053 S	04/1996 - 10/2002	B 180 APC	B 180 EHD	B 185 APC	
ACTROS 2531 LS	09/1996 - 10/2002	B 180 APC	B 180 EHD	B 185 APC	
ACTROS 2531,2531 L	09/1996 - 10/2002	B 180 APC	B 180 EHD	B 185 APC	
ACTROS 2535 L	09/1996 - 10/2002	B 180 APC	B 180 EHD	B 185 APC	
ACTROS 2535 LS	09/1996 - 10/2002	B 180 APC	B 180 EHD	B 185 APC	
ACTROS 2535 LS	09/2002 - 10/2002	B 180 APC	B 180 EHD	B 185 APC	
ACTROS 2540 LS	09/1996 - 10/2002	B 180 APC	B 180 EHD	B 185 APC	
ACTROS 2540,2540 L	09/1996 - 10/2002	B 180 APC	B 180 EHD	B 185 APC	
ACTROS 2543 LS	09/1996 - 10/2002	B 180 APC	B 180 EHD	B 185 APC	
ACTROS 2543,2543 L	09/1996 - 10/2002	B 180 APC	B 180 EHD	B 185 APC	
ACTROS 2546 LS	10/1997 -	B 180 APC	B 180 EHD	B 185 APC	
ACTROS 2548 LS	09/1996 - 10/2002	B 180 APC	B 180 EHD	B 185 APC	
ACTROS 2548,2548 L	09/1996 - 10/2002	B 180 APC	B 180 EHD	B 185 APC	
ACTROS 2553 LS	09/1996 - 10/2002	B 180 APC	B 180 EHD	B 185 APC	
ACTROS 2553,2553 L	09/1996 - 10/2002	B 180 APC	B 180 EHD	B 185 APC	
ACTROS 2557 L	09/1996 - 10/2002	B 180 APC	B 180 EHD	B 185 APC	
ACTROS 2631 B	04/1997 - 10/2002	B 180 APC	B 180 EHD	B 185 APC	
ACTROS 2631 K	04/1997 - 10/2002	B 180 APC	B 180 EHD	B 185 APC	
ACTROS 2631,2631 L	04/1997 - 10/2002	B 180 APC	B 180 EHD	B 185 APC	
ACTROS 2635 B	04/1997 - 10/2002	B 180 APC	B 180 EHD	B 185 APC	
ACTROS 2635 K	04/1997 - 10/2002	B 180 APC	B 180 EHD	B 185 APC	
ACTROS 2635,2635 L	04/1997 - 10/2002	B 180 APC	B 180 EHD	B 185 APC	
ACTROS 2640 B	04/1997 - 10/2002	B 180 APC	B 180 EHD	B 185 APC	
ACTROS 2640 K,2640 LK	04/1997 - 10/2002	B 180 APC	B 180 EHD	B 185 APC	

MARCHIO E MODELLO - MAKE AND MODEL MARQUE ET MODÈLE - MARKE UND MODELL MARCA Y MODELO - МАРКА И МОДЕЛЬ	Periodo Period	powerCUBE		energyCUBE	
		APC	EHD	APC	RST
MERCEDES-BENZ cont.					
ACTROS 2640 S,2640 LS	09/1996 - 10/2002	B 180 APC	B 180 EHD	B 185 APC	
ACTROS 2640,2640 L	04/1997 - 10/2002	B 180 APC	B 180 EHD	B 185 APC	
ACTROS 2643 B	04/1997 - 10/2002	B 180 APC	B 180 EHD	B 185 APC	
ACTROS 2643 K,2643 LK	04/1997 - 10/2002	B 180 APC	B 180 EHD	B 185 APC	
ACTROS 2643 S,2643 LS	04/1997 - 10/2002	B 180 APC	B 180 EHD	B 185 APC	
ACTROS 2643,2643 L	04/1997 - 10/2002	B 180 APC	B 180 EHD	B 185 APC	
ACTROS 2646 B	10/1997 -	B 180 APC	B 180 EHD	B 185 APC	
ACTROS 2646 LS	10/1997 -	B 180 APC	B 180 EHD	B 185 APC	
ACTROS 2648 K, 2648 LK	10/1997 -	B 180 APC	B 180 EHD	B 185 APC	
ACTROS 2648 K,2648 LK	04/1997 - 10/2002	B 180 APC	B 180 EHD	B 185 APC	
ACTROS 2648 S, 2648 LS	10/1997 -	B 180 APC	B 180 EHD	B 185 APC	
ACTROS 2648 S,2648 LS	09/1996 - 10/2002	B 180 APC	B 180 EHD	B 185 APC	
ACTROS 2648,2648 L	09/1996 - 10/2002	B 180 APC	B 180 EHD	B 185 APC	
ACTROS 2650 S, 2650 LS	10/1997 -	B 180 APC	B 180 EHD	B 185 APC	
ACTROS 2653 K,2653 LK	04/1997 - 10/2002	B 180 APC	B 180 EHD	B 185 APC	
ACTROS 2653 S,2653 LS	09/1996 - 10/2002	B 180 APC	B 180 EHD	B 185 APC	
ACTROS 2653,2653 L	04/1997 - 10/2002	B 180 APC	B 180 EHD	B 185 APC	
ACTROS 2657 K,2657 LK	04/1997 - 10/2002	B 180 APC	B 180 EHD	B 185 APC	
ACTROS 2657 L	04/1997 - 10/2002	B 180 APC	B 180 EHD	B 185 APC	
ACTROS 2657 S	04/1997 - 10/2002	B 180 APC	B 180 EHD	B 185 APC	
ACTROS 2665 LS	10/2002 -	B 180 APC	B 180 EHD	B 185 APC	
ACTROS 3231 B	04/1997 - 10/2002	B 180 APC	B 180 EHD	B 185 APC	
ACTROS 3231 K	04/1997 - 10/2002	B 180 APC	B 180 EHD	B 185 APC	
ACTROS 3235	04/1997 - 10/2002	B 180 APC	B 180 EHD	B 185 APC	
ACTROS 3235 B	04/1997 - 10/2002	B 180 APC	B 180 EHD	B 185 APC	
ACTROS 3235 K	04/1997 - 10/2002	B 180 APC	B 180 EHD	B 185 APC	
ACTROS 3240	04/1997 - 10/2002	B 180 APC	B 180 EHD	B 185 APC	
ACTROS 3240 B	04/1997 - 10/2002	B 180 APC	B 180 EHD	B 185 APC	
ACTROS 3240 K	04/1997 - 10/2002	B 180 APC	B 180 EHD	B 185 APC	
ACTROS 3243	04/1997 - 10/2002	B 180 APC	B 180 EHD	B 185 APC	
ACTROS 3243 B	04/1997 - 10/2002	B 180 APC	B 180 EHD	B 185 APC	
ACTROS 3243 K	04/1997 - 10/2002	B 180 APC	B 180 EHD	B 185 APC	
ACTROS 3246 B	10/1997 -	B 180 APC	B 180 EHD	B 185 APC	
ACTROS 3246 K	10/1997 -	B 180 APC	B 180 EHD	B 185 APC	
ACTROS 3331	04/1997 - 10/2002	B 180 APC	B 180 EHD	B 185 APC	
ACTROS 3331 A	04/1997 - 10/2002	B 180 APC	B 180 EHD	B 185 APC	
ACTROS 3331 AK	04/1997 - 10/2002	B 180 APC	B 180 EHD	B 185 APC	
ACTROS 3331 AS	04/1997 - 10/2002	B 180 APC	B 180 EHD	B 185 APC	
ACTROS 3331 B	04/1997 - 10/2002	B 180 APC	B 180 EHD	B 185 APC	
ACTROS 3331 K	04/1997 - 10/2002	B 180 APC	B 180 EHD	B 185 APC	
ACTROS 3331 S	04/1997 - 10/2002	B 180 APC	B 180 EHD	B 185 APC	
ACTROS 3335	04/1997 - 10/2002	B 180 APC	B 180 EHD	B 185 APC	
ACTROS 3335 AK	10/1997 - 10/2003	B 180 APC	B 180 EHD	B 185 APC	
ACTROS 3335 B	04/1997 - 10/2002	B 180 APC	B 180 EHD	B 185 APC	
ACTROS 3335 K	04/1997 - 10/2002	B 180 APC	B 180 EHD	B 185 APC	

MARCHIO E MODELLO - MAKE AND MODEL MARQUE ET MODÈLE - MARKE UND MODELL MARCA Y MODELO - МАРКА И МОДЕЛЬ	Periodo Period	powerCUBE		energyCUBE	
		APC	EHD	APC	RST
MERCEDES-BENZ cont.					
ACTROS 3335 S	04/1997 - 10/2002	B 180 APC	B 180 EHD	B 185 APC	
ACTROS 3336 S	10/1997 -	B 180 APC	B 180 EHD	B 185 APC	
ACTROS 3340	04/1997 - 10/2002	B 180 APC	B 180 EHD	B 185 APC	
ACTROS 3340 A	04/1997 - 10/2002	B 180 APC	B 180 EHD	B 185 APC	
ACTROS 3340 AK	04/1997 - 10/2002	B 180 APC	B 180 EHD	B 185 APC	
ACTROS 3340 AS	04/1997 - 10/2002	B 180 APC	B 180 EHD	B 185 APC	
ACTROS 3340 B	04/1997 - 10/2002	B 180 APC	B 180 EHD	B 185 APC	
ACTROS 3340 K	04/1997 - 10/2002	B 180 APC	B 180 EHD	B 185 APC	
ACTROS 3340 S	04/1997 - 10/2002	B 180 APC	B 180 EHD	B 185 APC	
ACTROS 3341 S	10/1997 -	B 180 APC	B 180 EHD	B 185 APC	
ACTROS 3343	04/1997 - 10/2002	B 180 APC	B 180 EHD	B 185 APC	
ACTROS 3343 AK	04/1997 - 10/2002	B 180 APC	B 180 EHD	B 185 APC	
ACTROS 3343 AS	04/1997 - 10/2002	B 180 APC	B 180 EHD	B 185 APC	
ACTROS 3343 B	04/1997 - 10/2002	B 180 APC	B 180 EHD	B 185 APC	
ACTROS 3343 K	04/1997 - 10/2002	B 180 APC	B 180 EHD	B 185 APC	
ACTROS 3343 S	04/1997 - 10/2002	B 180 APC	B 180 EHD	B 185 APC	
ACTROS 3346 AK	10/1997 -	B 180 APC	B 180 EHD	B 185 APC	
ACTROS 3346 AS	10/1997 -	B 180 APC	B 180 EHD	B 185 APC	
ACTROS 3346 K	10/1997 -	B 180 APC	B 180 EHD	B 185 APC	
ACTROS 3346 S	10/1997 -	B 180 APC	B 180 EHD	B 185 APC	
ACTROS 3348	04/1997 - 10/2002	B 180 APC	B 180 EHD	B 185 APC	
ACTROS 3348 AK	04/1997 - 10/2002	B 180 APC	B 180 EHD	B 185 APC	
ACTROS 3348 AS	04/1997 - 10/2002	B 180 APC	B 180 EHD	B 185 APC	
ACTROS 3348 K	04/1997 - 10/2002	B 180 APC	B 180 EHD	B 185 APC	
ACTROS 3348 S	04/1997 - 10/2002	B 180 APC	B 180 EHD	B 185 APC	
ACTROS 3350 AK	10/1997 -	B 180 APC	B 180 EHD	B 185 APC	
ACTROS 3350 AS	10/1997 -	B 180 APC	B 180 EHD	B 185 APC	
ACTROS 3350 K	10/1997 -	B 180 APC	B 180 EHD	B 185 APC	
ACTROS 3350 S	10/1997 -	B 180 APC	B 180 EHD	B 185 APC	
ACTROS 3353	04/1997 - 10/2002	B 180 APC	B 180 EHD	B 185 APC	
ACTROS 3353 AS	04/1997 - 10/2002	B 180 APC	B 180 EHD	B 185 APC	
ACTROS 3353 S	04/1997 - 10/2002	B 180 APC	B 180 EHD	B 185 APC	
ACTROS 3357	04/1997 - 10/2002	B 180 APC	B 180 EHD	B 185 APC	
ACTROS 3357 S	04/1997 - 10/2002	B 180 APC	B 180 EHD	B 185 APC	
ACTROS 4140 AK	04/1997 - 10/2002	B 180 APC	B 180 EHD	B 185 APC	
ACTROS 4140 B	04/1997 - 10/2002	B 180 APC	B 180 EHD	B 185 APC	
ACTROS 4140 K	04/1997 - 10/2002	B 180 APC	B 180 EHD	B 185 APC	
ACTROS 4143 AK	04/1997 - 10/2002	B 180 APC	B 180 EHD	B 185 APC	
ACTROS 4143 K	04/1997 - 10/2002	B 180 APC	B 180 EHD	B 185 APC	
ACTROS 4146 AK	10/1997 -	B 180 APC	B 180 EHD	B 185 APC	
ACTROS 4146 K	10/1997 -	B 180 APC	B 180 EHD	B 185 APC	
ACTROS 4148 AK	04/1997 - 10/2002	B 180 APC	B 180 EHD	B 185 APC	
ACTROS 4148 K	04/1997 - 10/2002	B 180 APC	B 180 EHD	B 185 APC	
ACTROS 521831,1831 L	09/1996 - 10/2002	B 180 APC	B 180 EHD	B 185 APC	
ACTROS MP2 1831 AK	04/2003 -	B 180 APC	B 180 EHD	B 185 APC	

MARCHIO E MODELLO - MAKE AND MODEL MARQUE ET MODÈLE - MARKE UND MODELL MARCA Y MODELO - МАРКА И МОДЕЛЬ	Periodo Period	powerCUBE		energyCUBE	
		APC	EHD	APC	RST
MERCEDES-BENZ cont.					
ACTROS MP2 1831 K	04/2003 -	B 180 APC	B 180 EHD	B 185 APC	
ACTROS MP2 1832	04/2003 -	B 180 APC	B 180 EHD	B 185 APC	
ACTROS MP2 1832 LS	04/2003 -	B 180 APC	B 180 EHD	B 185 APC	
ACTROS MP2 1832, L, LL	04/2003 -	B 180 APC	B 180 EHD	B 185 APC	
ACTROS MP2 1835 AK	04/2003 -	B 180 APC	B 180 EHD	B 185 APC	
ACTROS MP2 1835 K	04/2003 -	B 180 APC	B 180 EHD	B 185 APC	
ACTROS MP2 1836 A		B 180 APC	B 180 EHD	B 185 APC	
ACTROS MP2 1836 AK	04/2003 -	B 180 APC	B 180 EHD	B 185 APC	
ACTROS MP2 1836 K	04/2003 -	B 180 APC	B 180 EHD	B 185 APC	
ACTROS MP2 1836 LS	04/2003 -	B 180 APC	B 180 EHD	B 185 APC	
ACTROS MP2 1836 LS, LLS	06/2008 -	B 180 APC	B 180 EHD	B 185 APC	
ACTROS MP2 1836, L, LL	04/2003 -	B 180 APC	B 180 EHD	B 185 APC	
ACTROS MP2 1840 AK	04/2003 -	B 180 APC	B 180 EHD	B 185 APC	
ACTROS MP2 1840 K	04/2003 -	B 180 APC	B 180 EHD	B 185 APC	
ACTROS MP2 1840 LS, LLS	06/2008 -	B 180 APC	B 180 EHD	B 185 APC	
ACTROS MP2 1841 A		B 180 APC	B 180 EHD	B 185 APC	
ACTROS MP2 1841 AK	06/2008 -	B 180 APC	B 180 EHD	B 185 APC	
ACTROS MP2 1841 K	04/2003 -	B 180 APC	B 180 EHD	B 185 APC	
ACTROS MP2 1841, L, LL	04/2003 -	B 180 APC	B 180 EHD	B 185 APC	
ACTROS MP2 1842 L	10/2010 -	B 180 APC	B 180 EHD	B 185 APC	
ACTROS MP2 1842 LS	10/2010 -	B 180 APC	B 180 EHD	B 185 APC	
ACTROS MP2 1843 LS, LLS	06/2008 -	B 180 APC	B 180 EHD	B 185 APC	
ACTROS MP2 1844 A	04/2003 -	B 180 APC	B 180 EHD	B 185 APC	
ACTROS MP2 1844 K	04/2003 -	B 180 APC	B 180 EHD	B 185 APC	
ACTROS MP2 1844 LS	04/2003 -	B 180 APC	B 180 EHD	B 185 APC	
ACTROS MP2 1844, L, LL	04/2003 -	B 180 APC	B 180 EHD	B 185 APC	
ACTROS MP2 1846 A	04/2003 -	B 180 APC	B 180 EHD	B 185 APC	
ACTROS MP2 1846 K	04/2003 -	B 180 APC	B 180 EHD	B 185 APC	
ACTROS MP2 1846 LS	04/2003 -	B 180 APC	B 180 EHD	B 185 APC	
ACTROS MP2 1846, L, LL	04/2003 -	B 180 APC	B 180 EHD	B 185 APC	
ACTROS MP2 1848 A	04/2003 -	B 180 APC	B 180 EHD	B 185 APC	
ACTROS MP2 1848 AK	04/2003 -	B 180 APC	B 180 EHD	B 185 APC	
ACTROS MP2 1848 K	04/2003 -	B 180 APC	B 180 EHD	B 185 APC	
ACTROS MP2 1848 LS	04/2003 -	B 180 APC	B 180 EHD	B 185 APC	
ACTROS MP2 1848 S, LS	04/2003 -	B 180 APC	B 180 EHD	B 185 APC	
ACTROS MP2 1848, L, LL	04/2003 -	B 180 APC	B 180 EHD	B 185 APC	
ACTROS MP2 1850 K	04/2003 -	B 180 APC	B 180 EHD	B 185 APC	
ACTROS MP2 1850 LS	04/2003 -	B 180 APC	B 180 EHD	B 185 APC	
ACTROS MP2 1850, L, LL	04/2003 -	B 180 APC	B 180 EHD	B 185 APC	
ACTROS MP2 1851 A	04/2003 -	B 180 APC	B 180 EHD	B 185 APC	
ACTROS MP2 1854, L	04/2003 -	B 180 APC	B 180 EHD	B 185 APC	
ACTROS MP2 1854, L, LL	04/2003 -	B 180 APC	B 180 EHD	B 185 APC	
ACTROS MP2 1855 LS, LLS	06/2008 -	B 180 APC	B 180 EHD	B 185 APC	
ACTROS MP2 1855, L	06/2008 -	B 180 APC	B 180 EHD	B 185 APC	
ACTROS MP2 1858, L	04/2003 -	B 180 APC	B 180 EHD	B 185 APC	

MARCHIO E MODELLO - MAKE AND MODEL MARQUE ET MODÈLE - MARKE UND MODELL MARCA Y MODELO - МАРКА И МОДЕЛЬ	Periodo Period	powerCUBE		energyCUBE	
		APC	EHD	APC	RST
MERCEDES-BENZ cont.					
ACTROS MP2 1860 L, LL	05/2005 -	B 180 APC	B 180 EHD	B 185 APC	
ACTROS MP2 1860 LS	06/2008 -	B 180 APC	B 180 EHD	B 185 APC	
ACTROS MP2 1861 LS	05/2005 -	B 180 APC	B 180 EHD	B 185 APC	
ACTROS MP2 2032	04/2003 -	B 180 APC	B 180 EHD	B 185 APC	
ACTROS MP2 2032 A	04/2003 -	B 180 APC	B 180 EHD	B 185 APC	
ACTROS MP2 2032 AK	04/2003 -	B 180 APC	B 180 EHD	B 185 APC	
ACTROS MP2 2032 AS	04/2003 -	B 180 APC	B 180 EHD	B 185 APC	
ACTROS MP2 2032 K	04/2003 -	B 180 APC	B 180 EHD	B 185 APC	
ACTROS MP2 2032 S	04/2003 -	B 180 APC	B 180 EHD	B 185 APC	
ACTROS MP2 2036	04/2003 -	B 180 APC	B 180 EHD	B 185 APC	
ACTROS MP2 2036 A	04/2003 -	B 180 APC	B 180 EHD	B 185 APC	
ACTROS MP2 2036 AK	04/2003 -	B 180 APC	B 180 EHD	B 185 APC	
ACTROS MP2 2036 AS	04/2003 -	B 180 APC	B 180 EHD	B 185 APC	
ACTROS MP2 2036 K	06/2008 -	B 180 APC	B 180 EHD	B 185 APC	
ACTROS MP2 2036 S	04/2003 -	B 180 APC	B 180 EHD	B 185 APC	
ACTROS MP2 2040	11/2002 -	B 180 APC	B 180 EHD	B 185 APC	
ACTROS MP2 2041	04/2003 -	B 180 APC	B 180 EHD	B 185 APC	
ACTROS MP2 2041 AK	04/2003 -	B 180 APC	B 180 EHD	B 185 APC	
ACTROS MP2 2041 AS	04/2003 -	B 180 APC	B 180 EHD	B 185 APC	
ACTROS MP2 2041 K	04/2003 -	B 180 APC	B 180 EHD	B 185 APC	
ACTROS MP2 2041 S	04/2003 -	B 180 APC	B 180 EHD	B 185 APC	
ACTROS MP2 2044	04/2003 -	B 180 APC	B 180 EHD	B 185 APC	
ACTROS MP2 2044 AK	04/2003 -	B 180 APC	B 180 EHD	B 185 APC	
ACTROS MP2 2044 AS	04/2003 -	B 180 APC	B 180 EHD	B 185 APC	
ACTROS MP2 2044 K	06/2008 -	B 180 APC	B 180 EHD	B 185 APC	
ACTROS MP2 2044 S	04/2003 -	B 180 APC	B 180 EHD	B 185 APC	
ACTROS MP2 2046	04/2003 -	B 180 APC	B 180 EHD	B 185 APC	
ACTROS MP2 2046 AK	04/2003 -	B 180 APC	B 180 EHD	B 185 APC	
ACTROS MP2 2046 AS	04/2003 -	B 180 APC	B 180 EHD	B 185 APC	
ACTROS MP2 2046 K	06/2008 -	B 180 APC	B 180 EHD	B 185 APC	
ACTROS MP2 2046 S	04/2003 -	B 180 APC	B 180 EHD	B 185 APC	
ACTROS MP2 2048	06/2008 -	B 180 APC	B 180 EHD	B 185 APC	
ACTROS MP2 2048 AK	04/2003 -	B 180 APC	B 180 EHD	B 185 APC	
ACTROS MP2 2048 AS	04/2003 -	B 180 APC	B 180 EHD	B 185 APC	
ACTROS MP2 2048 K	06/2008 -	B 180 APC	B 180 EHD	B 185 APC	
ACTROS MP2 2048 S	06/2008 -	B 180 APC	B 180 EHD	B 185 APC	
ACTROS MP2 2050 S	04/2003 -	B 180 APC	B 180 EHD	B 185 APC	
ACTROS MP2 2051 AS	04/2003 -	B 180 APC	B 180 EHD	B 185 APC	
ACTROS MP2 2051 S	06/2008 -	B 180 APC	B 180 EHD	B 185 APC	
ACTROS MP2 2054 S	04/2003 -	B 180 APC	B 180 EHD	B 185 APC	
ACTROS MP2 2055 S	06/2008 -	B 180 APC	B 180 EHD	B 185 APC	
ACTROS MP2 2432 LS	06/2008 -	B 180 APC	B 180 EHD	B 185 APC	
ACTROS MP2 2436 LS	06/2008 -	B 180 APC	B 180 EHD	B 185 APC	
ACTROS MP2 2441 LS	06/2008 -	B 180 APC	B 180 EHD	B 185 APC	
ACTROS MP2 2444 LS	06/2008 -	B 180 APC	B 180 EHD	B 185 APC	

MARCHIO E MODELLO - MAKE AND MODEL MARQUE ET MODÈLE - MARKE UND MODELL MARCA Y MODELO - МАРКА И МОДЕЛЬ	Periodo Period	powerCUBE		energyCUBE	
		APC	EHD	APC	RST
MERCEDES-BENZ cont.					
ACTROS MP2 2446 LS	06/2008 -	B 180 APC	B 180 EHD	B 185 APC	
ACTROS MP2 2448 LS	06/2008 -	B 180 APC	B 180 EHD	B 185 APC	
ACTROS MP2 2451 LS	06/2008 -	B 180 APC	B 180 EHD	B 185 APC	
ACTROS MP2 2455 LS	06/2008 -	B 180 APC	B 180 EHD	B 185 APC	
ACTROS MP2 2460 LS	06/2008 -	B 180 APC	B 180 EHD	B 185 APC	
ACTROS MP2 2532 LS	04/2003 -	B 180 APC	B 180 EHD	B 185 APC	
ACTROS MP2 2532 LS	06/2008 -	B 180 APC	B 180 EHD	B 185 APC	
ACTROS MP2 2532, L	04/2003 -	B 180 APC	B 180 EHD	B 185 APC	
ACTROS MP2 2536 L, LL	06/2008 -	B 180 APC	B 180 EHD	B 185 APC	
ACTROS MP2 2536 LS	04/2003 -	B 180 APC	B 180 EHD	B 185 APC	
ACTROS MP2 2536 LS	06/2008 -	B 180 APC	B 180 EHD	B 185 APC	
ACTROS MP2 2536, L	04/2003 -	B 180 APC	B 180 EHD	B 185 APC	
ACTROS MP2 2540 L, LL	06/2008 -	B 180 APC	B 180 EHD	B 185 APC	
ACTROS MP2 2541 LS	04/2003 -	B 180 APC	B 180 EHD	B 185 APC	
ACTROS MP2 2541 LS	06/2008 -	B 180 APC	B 180 EHD	B 185 APC	
ACTROS MP2 2541, L	04/2003 -	B 180 APC	B 180 EHD	B 185 APC	
ACTROS MP2 2542 L	10/2010 -	B 180 APC	B 180 EHD	B 185 APC	
ACTROS MP2 2543 L, LL	06/2008 -	B 180 APC	B 180 EHD	B 185 APC	
ACTROS MP2 2544 LS	04/2003 -	B 180 APC	B 180 EHD	B 185 APC	
ACTROS MP2 2544 LS	06/2008 -	B 180 APC	B 180 EHD	B 185 APC	
ACTROS MP2 2544, L	04/2003 -	B 180 APC	B 180 EHD	B 185 APC	
ACTROS MP2 2546 LS	04/2003 -	B 180 APC	B 180 EHD	B 185 APC	
ACTROS MP2 2546 LS	06/2008 -	B 180 APC	B 180 EHD	B 185 APC	
ACTROS MP2 2546, L	04/2003 -	B 180 APC	B 180 EHD	B 185 APC	
ACTROS MP2 2548 L	04/2003 -	B 180 APC	B 180 EHD	B 185 APC	
ACTROS MP2 2548 LS	04/2003 -	B 180 APC	B 180 EHD	B 185 APC	
ACTROS MP2 2548 LS	06/2008 -	B 180 APC	B 180 EHD	B 185 APC	
ACTROS MP2 2548, L	04/2003 -	B 180 APC	B 180 EHD	B 185 APC	
ACTROS MP2 2550 LS	04/2003 -	B 180 APC	B 180 EHD	B 185 APC	
ACTROS MP2 2550, LS	04/2003 -	B 180 APC	B 180 EHD	B 185 APC	
ACTROS MP2 2551 LS	04/2003 -	B 180 APC	B 180 EHD	B 185 APC	
ACTROS MP2 2551, L,LL	04/2003 -	B 180 APC	B 180 EHD	B 185 APC	
ACTROS MP2 2553 L	04/2003 -	B 180 APC	B 180 EHD	B 185 APC	
ACTROS MP2 2554 LS	04/2003 -	B 180 APC	B 180 EHD	B 185 APC	
ACTROS MP2 2554, L	04/2003 -	B 180 APC	B 180 EHD	B 185 APC	
ACTROS MP2 2555 LS	09/2005 -	B 180 APC	B 180 EHD	B 185 APC	
ACTROS MP2 2555, L, LL	04/2003 -	B 180 APC	B 180 EHD	B 185 APC	
ACTROS MP2 2558, L	04/2003 -	B 180 APC	B 180 EHD	B 185 APC	
ACTROS MP2 2560, L, LL	04/2003 -	B 180 APC	B 180 EHD	B 185 APC	
ACTROS MP2 2631 B	04/2003 -	B 180 APC	B 180 EHD	B 185 APC	
ACTROS MP2 2631 K, LK	04/2003 -	B 180 APC	B 180 EHD	B 185 APC	
ACTROS MP2 2631 L	04/2003 -	B 180 APC	B 180 EHD	B 185 APC	
ACTROS MP2 2631 LS	10/2002 -	B 180 APC	B 180 EHD	B 185 APC	
ACTROS MP2 2631 LS	10/2009 -	B 180 APC	B 180 EHD	B 185 APC	
ACTROS MP2 2632 B	04/2003 -	B 180 APC	B 180 EHD	B 185 APC	

MARCHIO E MODELLO - MAKE AND MODEL MARQUE ET MODÈLE - MARKE UND MODELL MARCA Y MODELO - МАРКА И МОДЕЛЬ	Periodo Period	powerCUBE		energyCUBE	
		APC	EHD	APC	RST
MERCEDES-BENZ cont.					
ACTROS MP2 2632 K, LK	04/2003 -	B 180 APC	B 180 EHD	B 185 APC	
ACTROS MP2 2632 LS	04/2003 -	B 180 APC	B 180 EHD	B 185 APC	
ACTROS MP2 2632 LS	10/2009 -	B 180 APC	B 180 EHD	B 185 APC	
ACTROS MP2 2635 B	04/2003 -	B 180 APC	B 180 EHD	B 185 APC	
ACTROS MP2 2635 K, LK	04/2003 -	B 180 APC	B 180 EHD	B 185 APC	
ACTROS MP2 2635 L	04/2003 -	B 180 APC	B 180 EHD	B 185 APC	
ACTROS MP2 2635 LS	10/2002 -	B 180 APC	B 180 EHD	B 185 APC	
ACTROS MP2 2635 LS	10/2009 -	B 180 APC	B 180 EHD	B 185 APC	
ACTROS MP2 2636 B	04/2003 -	B 180 APC	B 180 EHD	B 185 APC	
ACTROS MP2 2636 K	04/2003 -	B 180 APC	B 180 EHD	B 185 APC	
ACTROS MP2 2636 LS	04/2003 -	B 180 APC	B 180 EHD	B 185 APC	
ACTROS MP2 2636 LS	10/2009 -	B 180 APC	B 180 EHD	B 185 APC	
ACTROS MP2 2636, L	04/2003 -	B 180 APC	B 180 EHD	B 185 APC	
ACTROS MP2 2640 B	04/2003 -	B 180 APC	B 180 EHD	B 185 APC	
ACTROS MP2 2640 K, LK	04/2003 -	B 180 APC	B 180 EHD	B 185 APC	
ACTROS MP2 2640 L	04/2003 -	B 180 APC	B 180 EHD	B 185 APC	
ACTROS MP2 2640 LS	10/2002 -	B 180 APC	B 180 EHD	B 185 APC	
ACTROS MP2 2640 LS	10/2009 -	B 180 APC	B 180 EHD	B 185 APC	
ACTROS MP2 2641 B	04/2003 -	B 180 APC	B 180 EHD	B 185 APC	
ACTROS MP2 2641 K	04/2003 -	B 180 APC	B 180 EHD	B 185 APC	
ACTROS MP2 2641 LS	10/2009 -	B 180 APC	B 180 EHD	B 185 APC	
ACTROS MP2 2641 S, LS	04/2003 -	B 180 APC	B 180 EHD	B 185 APC	
ACTROS MP2 2641, L	04/2003 -	B 180 APC	B 180 EHD	B 185 APC	
ACTROS MP2 2643 B	04/2003 -	B 180 APC	B 180 EHD	B 185 APC	
ACTROS MP2 2643 K, LK	04/2003 -	B 180 APC	B 180 EHD	B 185 APC	
ACTROS MP2 2643 L	04/2003 -	B 180 APC	B 180 EHD	B 185 APC	
ACTROS MP2 2643 LS	10/2009 -	B 180 APC	B 180 EHD	B 185 APC	
ACTROS MP2 2644 B	04/2003 -	B 180 APC	B 180 EHD	B 185 APC	
ACTROS MP2 2644 K	04/2003 -	B 180 APC	B 180 EHD	B 185 APC	
ACTROS MP2 2644 S, LS	04/2003 -	B 180 APC	B 180 EHD	B 185 APC	
ACTROS MP2 2644, L	04/2003 -	B 180 APC	B 180 EHD	B 185 APC	
ACTROS MP2 2646 B	04/2003 -	B 180 APC	B 180 EHD	B 185 APC	
ACTROS MP2 2646 K	04/2003 -	B 180 APC	B 180 EHD	B 185 APC	
ACTROS MP2 2646 LS	10/2009 -	B 180 APC	B 180 EHD	B 185 APC	
ACTROS MP2 2646 S, LS	04/2003 -	B 180 APC	B 180 EHD	B 185 APC	
ACTROS MP2 2646, L	04/2003 -	B 180 APC	B 180 EHD	B 185 APC	
ACTROS MP2 2648 B	04/2003 -	B 180 APC	B 180 EHD	B 185 APC	
ACTROS MP2 2648 K, LK	04/2003 -	B 180 APC	B 180 EHD	B 185 APC	
ACTROS MP2 2648 L	04/2003 -	B 180 APC	B 180 EHD	B 185 APC	
ACTROS MP2 2648 LS	10/2002 -	B 180 APC	B 180 EHD	B 185 APC	
ACTROS MP2 2648 LS	10/2009 -	B 180 APC	B 180 EHD	B 185 APC	
ACTROS MP2 2648 S, LS	04/2003 -	B 180 APC	B 180 EHD	B 185 APC	
ACTROS MP2 2648, L, LL	06/2008 -	B 180 APC	B 180 EHD	B 185 APC	
ACTROS MP2 2650 K	04/2003 -	B 180 APC	B 180 EHD	B 185 APC	
ACTROS MP2 2650 S, LS	04/2003 -	B 180 APC	B 180 EHD	B 185 APC	

MARCHIO E MODELLO - MAKE AND MODEL MARQUE ET MODÈLE - MARKE UND MODELL MARCA Y MODELO - МАРКА И МОДЕЛЬ	Periodo Period	powerCUBE		energyCUBE	
		APC	EHD	APC	RST
MERCEDES-BENZ cont.					
ACTROS MP2 2650, L	04/2003 -	B 180 APC	B 180 EHD	B 185 APC	
ACTROS MP2 2651 L	04/2003 -	B 180 APC	B 180 EHD	B 185 APC	
ACTROS MP2 2651 LS	10/2009 -	B 180 APC	B 180 EHD	B 185 APC	
ACTROS MP2 2651 S, LS	04/2003 -	B 180 APC	B 180 EHD	B 185 APC	
ACTROS MP2 2653 K, LK	04/2003 -	B 180 APC	B 180 EHD	B 185 APC	
ACTROS MP2 2653 L	04/2003 -	B 180 APC	B 180 EHD	B 185 APC	
ACTROS MP2 2653 LS	10/2009 -	B 180 APC	B 180 EHD	B 185 APC	
ACTROS MP2 2654 K	04/2003 -	B 180 APC	B 180 EHD	B 185 APC	
ACTROS MP2 2654 S, LS	04/2003 -	B 180 APC	B 180 EHD	B 185 APC	
ACTROS MP2 2654, L	04/2003 -	B 180 APC	B 180 EHD	B 185 APC	
ACTROS MP2 2655 LS	10/2009 -	B 180 APC	B 180 EHD	B 185 APC	
ACTROS MP2 2655 S, LS	04/2003 -	B 180 APC	B 180 EHD	B 185 APC	
ACTROS MP2 2658 K	04/2003 -	B 180 APC	B 180 EHD	B 185 APC	
ACTROS MP2 2658 L	04/2003 -	B 180 APC	B 180 EHD	B 185 APC	
ACTROS MP2 2658 LS	04/2003 -	B 180 APC	B 180 EHD	B 185 APC	
ACTROS MP2 2660 L, LL	06/2008 -	B 180 APC	B 180 EHD	B 185 APC	
ACTROS MP2 2660 LK	04/2003 -	B 180 APC	B 180 EHD	B 185 APC	
ACTROS MP2 2660 S, LS	06/2008 -	B 180 APC	B 180 EHD	B 185 APC	
ACTROS MP2 2665 LS	04/2003 -	B 180 APC	B 180 EHD	B 185 APC	
ACTROS MP2 2732 AE	06/2008 -	B 180 APC	B 180 EHD	B 185 APC	
ACTROS MP2 2732 AKE	06/2008 -	B 180 APC	B 180 EHD	B 185 APC	
ACTROS MP2 2736 AE	06/2008 -	B 180 APC	B 180 EHD	B 185 APC	
ACTROS MP2 2736 AKE	06/2008 -	B 180 APC	B 180 EHD	B 185 APC	
ACTROS MP2 2741 AE	06/2008 -	B 180 APC	B 180 EHD	B 185 APC	
ACTROS MP2 2741 AKE	06/2008 -	B 180 APC	B 180 EHD	B 185 APC	
ACTROS MP2 2744 AE	06/2008 -	B 180 APC	B 180 EHD	B 185 APC	
ACTROS MP2 2744 AKE	06/2008 -	B 180 APC	B 180 EHD	B 185 APC	
ACTROS MP2 2746 AE	06/2008 -	B 180 APC	B 180 EHD	B 185 APC	
ACTROS MP2 2746 AKE	06/2008 -	B 180 APC	B 180 EHD	B 185 APC	
ACTROS MP2 2748 AE	06/2008 -	B 180 APC	B 180 EHD	B 185 APC	
ACTROS MP2 2748 AKE	06/2008 -	B 180 APC	B 180 EHD	B 185 APC	
ACTROS MP2 3231 B	04/2003 -	B 180 APC	B 180 EHD	B 185 APC	
ACTROS MP2 3231 K, 3232 K	04/2003 -	B 180 APC	B 180 EHD	B 185 APC	
ACTROS MP2 3232 B	04/2003 -	B 180 APC	B 180 EHD	B 185 APC	
ACTROS MP2 3235 B	04/2003 -	B 180 APC	B 180 EHD	B 185 APC	
ACTROS MP2 3235 K	04/2003 -	B 180 APC	B 180 EHD	B 185 APC	
ACTROS MP2 3236 B	04/2003 -	B 180 APC	B 180 EHD	B 185 APC	
ACTROS MP2 3236 K	04/2003 -	B 180 APC	B 180 EHD	B 185 APC	
ACTROS MP2 3236 L	06/2008 -	B 180 APC	B 180 EHD	B 185 APC	
ACTROS MP2 3240	04/2003 -	B 180 APC	B 180 EHD	B 185 APC	
ACTROS MP2 3240 B	04/2003 -	B 180 APC	B 180 EHD	B 185 APC	
ACTROS MP2 3240 K	04/2003 -	B 180 APC	B 180 EHD	B 185 APC	
ACTROS MP2 3241	04/2003 -	B 180 APC	B 180 EHD	B 185 APC	
ACTROS MP2 3241 B	04/2003 -	B 180 APC	B 180 EHD	B 185 APC	
ACTROS MP2 3241 K	04/2003 -	B 180 APC	B 180 EHD	B 185 APC	

MARCHIO E MODELLO - MAKE AND MODEL MARQUE ET MODÈLE - MARKE UND MODELL MARCA Y MODELO - МАРКА И МОДЕЛЬ	Periodo Period	powerCUBE		energyCUBE	
		APC	EHD	APC	RST
MERCEDES-BENZ cont.					
ACTROS MP2 3241 L	06/2008 -	B 180 APC	B 180 EHD	B 185 APC	
ACTROS MP2 3243	11/2002 -	B 180 APC	B 180 EHD	B 185 APC	
ACTROS MP2 3243 B	04/2003 -	B 180 APC	B 180 EHD	B 185 APC	
ACTROS MP2 3243 K	04/2003 -	B 180 APC	B 180 EHD	B 185 APC	
ACTROS MP2 3244	04/2003 -	B 180 APC	B 180 EHD	B 185 APC	
ACTROS MP2 3244 B	04/2003 -	B 180 APC	B 180 EHD	B 185 APC	
ACTROS MP2 3244 K	04/2003 -	B 180 APC	B 180 EHD	B 185 APC	
ACTROS MP2 3246	04/2003 -	B 180 APC	B 180 EHD	B 185 APC	
ACTROS MP2 3246 B	04/2003 -	B 180 APC	B 180 EHD	B 185 APC	
ACTROS MP2 3246 K	01/2002 -	B 180 APC	B 180 EHD	B 185 APC	
ACTROS MP2 3248	04/2003 -	B 180 APC	B 180 EHD	B 185 APC	
ACTROS MP2 3248 B	04/2003 -	B 180 APC	B 180 EHD	B 185 APC	
ACTROS MP2 3248 K	04/2003 -	B 180 APC	B 180 EHD	B 185 APC	
ACTROS MP2 3250	04/2003 -	B 180 APC	B 180 EHD	B 185 APC	
ACTROS MP2 3255 L	02/2009 -	B 180 APC	B 180 EHD	B 185 APC	
ACTROS MP2 3260 L	02/2009 -	B 180 APC	B 180 EHD	B 185 APC	
ACTROS MP2 3331 A, 3332 A	04/2003 -	B 180 APC	B 180 EHD	B 185 APC	
ACTROS MP2 3331 AK, 3332 AK	04/2003 -	B 180 APC	B 180 EHD	B 185 APC	
ACTROS MP2 3331 B	04/2003 -	B 180 APC	B 180 EHD	B 185 APC	
ACTROS MP2 3331 K	04/2003 -	B 180 APC	B 180 EHD	B 185 APC	
ACTROS MP2 3331 S, 3332 S	04/2003 -	B 180 APC	B 180 EHD	B 185 APC	
ACTROS MP2 3331, 3332	04/2003 -	B 180 APC	B 180 EHD	B 185 APC	
ACTROS MP2 3332 AK	04/2003 -	B 180 APC	B 180 EHD	B 185 APC	
ACTROS MP2 3332 AKE		B 180 APC	B 180 EHD	B 185 APC	
ACTROS MP2 3332 AS	04/2003 -	B 180 APC	B 180 EHD	B 185 APC	
ACTROS MP2 3332 B	04/2003 -	B 180 APC	B 180 EHD	B 185 APC	
ACTROS MP2 3332 K	04/2003 -	B 180 APC	B 180 EHD	B 185 APC	
ACTROS MP2 3335 A	04/2003 -	B 180 APC	B 180 EHD	B 185 APC	
ACTROS MP2 3335 B	04/2003 -	B 180 APC	B 180 EHD	B 185 APC	
ACTROS MP2 3335 K	04/2003 -	B 180 APC	B 180 EHD	B 185 APC	
ACTROS MP2 3336	04/2003 -	B 180 APC	B 180 EHD	B 185 APC	
ACTROS MP2 3336 A	04/2003 -	B 180 APC	B 180 EHD	B 185 APC	
ACTROS MP2 3336 AK	04/2003 -	B 180 APC	B 180 EHD	B 185 APC	
ACTROS MP2 3336 AKE		B 180 APC	B 180 EHD	B 185 APC	
ACTROS MP2 3336 AS	04/2003 -	B 180 APC	B 180 EHD	B 185 APC	
ACTROS MP2 3336 B	04/2003 -	B 180 APC	B 180 EHD	B 185 APC	
ACTROS MP2 3336 K	04/2003 -	B 180 APC	B 180 EHD	B 185 APC	
ACTROS MP2 3336 S	04/2003 -	B 180 APC	B 180 EHD	B 185 APC	
ACTROS MP2 3339 A	04/2003 -	B 180 APC	B 180 EHD	B 185 APC	
ACTROS MP2 3339 AK	04/2003 -	B 180 APC	B 180 EHD	B 185 APC	
ACTROS MP2 3339 B	04/2003 -	B 180 APC	B 180 EHD	B 185 APC	
ACTROS MP2 3339 K	04/2003 -	B 180 APC	B 180 EHD	B 185 APC	
ACTROS MP2 3341	04/2003 -	B 180 APC	B 180 EHD	B 185 APC	
ACTROS MP2 3341 A	04/2003 -	B 180 APC	B 180 EHD	B 185 APC	
ACTROS MP2 3341 AK	04/2003 -	B 180 APC	B 180 EHD	B 185 APC	

MARCHIO E MODELLO - MAKE AND MODEL MARQUE ET MODÈLE - MARKE UND MODELL MARCA Y MODELO - МАРКА И МОДЕЛЬ	Periodo Period	powerCUBE		energyCUBE	
		APC	EHD	APC	RST
MERCEDES-BENZ cont.					
ACTROS MP2 3341 AKE		B 180 APC	B 180 EHD	B 185 APC	
ACTROS MP2 3341 AS	04/2003 -	B 180 APC	B 180 EHD	B 185 APC	
ACTROS MP2 3341 B	04/2003 -	B 180 APC	B 180 EHD	B 185 APC	
ACTROS MP2 3341 K	04/2003 -	B 180 APC	B 180 EHD	B 185 APC	
ACTROS MP2 3341 S	04/2003 -	B 180 APC	B 180 EHD	B 185 APC	
ACTROS MP2 3343 AK	04/2003 -	B 180 APC	B 180 EHD	B 185 APC	
ACTROS MP2 3343 B	04/2003 -	B 180 APC	B 180 EHD	B 185 APC	
ACTROS MP2 3343 K	04/2003 -	B 180 APC	B 180 EHD	B 185 APC	
ACTROS MP2 3344	04/2003 -	B 180 APC	B 180 EHD	B 185 APC	
ACTROS MP2 3344 A	04/2003 -	B 180 APC	B 180 EHD	B 185 APC	
ACTROS MP2 3344 AK	04/2003 -	B 180 APC	B 180 EHD	B 185 APC	
ACTROS MP2 3344 AKE		B 180 APC	B 180 EHD	B 185 APC	
ACTROS MP2 3344 AS	04/2003 -	B 180 APC	B 180 EHD	B 185 APC	
ACTROS MP2 3344 B	04/2003 -	B 180 APC	B 180 EHD	B 185 APC	
ACTROS MP2 3344 K	04/2003 -	B 180 APC	B 180 EHD	B 185 APC	
ACTROS MP2 3344 S	04/2003 -	B 180 APC	B 180 EHD	B 185 APC	
ACTROS MP2 3346	04/2003 -	B 180 APC	B 180 EHD	B 185 APC	
ACTROS MP2 3346 A	04/2003 -	B 180 APC	B 180 EHD	B 185 APC	
ACTROS MP2 3346 AK	04/2003 -	B 180 APC	B 180 EHD	B 185 APC	
ACTROS MP2 3346 AKE		B 180 APC	B 180 EHD	B 185 APC	
ACTROS MP2 3346 AS	04/2003 -	B 180 APC	B 180 EHD	B 185 APC	
ACTROS MP2 3346 B	04/2003 -	B 180 APC	B 180 EHD	B 185 APC	
ACTROS MP2 3346 K	04/2003 -	B 180 APC	B 180 EHD	B 185 APC	
ACTROS MP2 3346 S	04/2003 -	B 180 APC	B 180 EHD	B 185 APC	
ACTROS MP2 3348		B 180 APC	B 180 EHD	B 185 APC	
ACTROS MP2 3348	04/2003 -	B 180 APC	B 180 EHD	B 185 APC	
ACTROS MP2 3348 A	04/2003 -	B 180 APC	B 180 EHD	B 185 APC	
ACTROS MP2 3348 AK	04/2003 -	B 180 APC	B 180 EHD	B 185 APC	
ACTROS MP2 3348 AKE		B 180 APC	B 180 EHD	B 185 APC	
ACTROS MP2 3348 AS	04/2003 -	B 180 APC	B 180 EHD	B 185 APC	
ACTROS MP2 3348 B	04/2003 -	B 180 APC	B 180 EHD	B 185 APC	
ACTROS MP2 3348 K	04/2003 -	B 180 APC	B 180 EHD	B 185 APC	
ACTROS MP2 3348 S	04/2003 -	B 180 APC	B 180 EHD	B 185 APC	
ACTROS MP2 3350 S	06/2009 -	B 180 APC	B 180 EHD	B 185 APC	
ACTROS MP2 3350, 3351	04/2003 -	B 180 APC	B 180 EHD	B 185 APC	
ACTROS MP2 3351 A	06/2008 -	B 180 APC	B 180 EHD	B 185 APC	
ACTROS MP2 3351 AK	04/2003 -	B 180 APC	B 180 EHD	B 185 APC	
ACTROS MP2 3351 AS	04/2003 -	B 180 APC	B 180 EHD	B 185 APC	
ACTROS MP2 3351 K	04/2003 -	B 180 APC	B 180 EHD	B 185 APC	
ACTROS MP2 3351 S	04/2003 -	B 180 APC	B 180 EHD	B 185 APC	
ACTROS MP2 3354, 3355	04/2003 -	B 180 APC	B 180 EHD	B 185 APC	
ACTROS MP2 3355 A	04/2003 -	B 180 APC	B 180 EHD	B 185 APC	
ACTROS MP2 3355 AK	04/2003 -	B 180 APC	B 180 EHD	B 185 APC	
ACTROS MP2 3355 AS	04/2003 -	B 180 APC	B 180 EHD	B 185 APC	
ACTROS MP2 3355 S	04/2003 -	B 180 APC	B 180 EHD	B 185 APC	

MARCHIO E MODELLO - MAKE AND MODEL MARQUE ET MODÈLE - MARKE UND MODELL MARCA Y MODELO - МАРКА И МОДЕЛЬ	Periodo Period	powerCUBE		energyCUBE	
		APC	EHD	APC	RST
MERCEDES-BENZ cont.					
ACTROS MP2 3358	04/2003 -	B 180 APC	B 180 EHD	B 185 APC	
ACTROS MP2 3358 K	04/2003 -	B 180 APC	B 180 EHD	B 185 APC	
ACTROS MP2 3360	04/2003 -	B 180 APC	B 180 EHD	B 185 APC	
ACTROS MP2 3360 A	04/2003 -	B 180 APC	B 180 EHD	B 185 APC	
ACTROS MP2 3360 AK	04/2003 -	B 180 APC	B 180 EHD	B 185 APC	
ACTROS MP2 3365 A	04/2003 -	B 180 APC	B 180 EHD	B 185 APC	
ACTROS MP2 3550 S	06/2009 -	B 180 APC	B 180 EHD	B 185 APC	
ACTROS MP2 4036 K	06/2009 -	B 180 APC	B 180 EHD	B 185 APC	
ACTROS MP2 4140 AK	04/2003 -	B 180 APC	B 180 EHD	B 185 APC	
ACTROS MP2 4140 B	04/2003 -	B 180 APC	B 180 EHD	B 185 APC	
ACTROS MP2 4140 K	04/2003 -	B 180 APC	B 180 EHD	B 185 APC	
ACTROS MP2 4141	06/2008 -	B 180 APC	B 180 EHD	B 185 APC	
ACTROS MP2 4141 AK	04/2003 -	B 180 APC	B 180 EHD	B 185 APC	
ACTROS MP2 4141 B	04/2003 -	B 180 APC	B 180 EHD	B 185 APC	
ACTROS MP2 4141 B	06/2008 -	B 180 APC	B 180 EHD	B 185 APC	
ACTROS MP2 4141 K	04/2003 -	B 180 APC	B 180 EHD	B 185 APC	
ACTROS MP2 4143 AK	04/2003 -	B 180 APC	B 180 EHD	B 185 APC	
ACTROS MP2 4143 B	04/2003 -	B 180 APC	B 180 EHD	B 185 APC	
ACTROS MP2 4143 K	04/2003 -	B 180 APC	B 180 EHD	B 185 APC	
ACTROS MP2 4144 AK	04/2003 -	B 180 APC	B 180 EHD	B 185 APC	
ACTROS MP2 4144 B	04/2003 -	B 180 APC	B 180 EHD	B 185 APC	
ACTROS MP2 4144 B	06/2008 -	B 180 APC	B 180 EHD	B 185 APC	
ACTROS MP2 4144 K	04/2003 -	B 180 APC	B 180 EHD	B 185 APC	
ACTROS MP2 4146 AK	04/2003 -	B 180 APC	B 180 EHD	B 185 APC	
ACTROS MP2 4146 B	04/2003 -	B 180 APC	B 180 EHD	B 185 APC	
ACTROS MP2 4146 B	06/2008 -	B 180 APC	B 180 EHD	B 185 APC	
ACTROS MP2 4146 K	04/2003 -	B 180 APC	B 180 EHD	B 185 APC	
ACTROS MP2 4148 AK	04/2003 -	B 180 APC	B 180 EHD	B 185 APC	
ACTROS MP2 4148 B	04/2003 -	B 180 APC	B 180 EHD	B 185 APC	
ACTROS MP2 4148 B	06/2008 -	B 180 APC	B 180 EHD	B 185 APC	
ACTROS MP2 4148 K	03/2000 -	B 180 APC	B 180 EHD	B 185 APC	
ACTROS MP2 4148 K	04/2003 -	B 180 APC	B 180 EHD	B 185 APC	
ACTROS MP2 4150 K	04/2003 -	B 180 APC	B 180 EHD	B 185 APC	
ACTROS MP2 4151 AK	04/2003 -	B 180 APC	B 180 EHD	B 185 APC	
ACTROS MP2 4151 K	04/2003 -	B 180 APC	B 180 EHD	B 185 APC	
ACTROS MP2 4151 K	05/2005 -	B 180 APC	B 180 EHD	B 185 APC	
ACTROS MP2 4154 S	04/2003 -	B 180 APC	B 180 EHD	B 185 APC	
ACTROS MP2 4155 AK	04/2003 -	B 180 APC	B 180 EHD	B 185 APC	
ACTROS MP2 4155 K	04/2003 -	B 180 APC	B 180 EHD	B 185 APC	
ACTROS MP2 4160 AK	04/2003 -	B 180 APC	B 180 EHD	B 185 APC	
ACTROS MP2 4160 K	04/2003 -	B 180 APC	B 180 EHD	B 185 APC	
ACTROS MP2 4160 S	10/2002 -	B 180 APC	B 180 EHD	B 185 APC	
ACTROS MP2 4165 AK	04/2003 -	B 180 APC	B 180 EHD	B 185 APC	
ACTROS MP2 4165 S	08/2008 -	B 180 APC	B 180 EHD	B 185 APC	
ACTROS MP2 4841 K	08/2009 -	B 180 APC	B 180 EHD	B 185 APC	

MARCHIO E MODELLO - MAKE AND MODEL MARQUE ET MODÈLE - MARKE UND MODELL MARCA Y MODELO - МАРКА И МОДЕЛЬ	Periodo <i>Period</i>	powerCUBE		energyCUBE	
		APC	EHD	APC	RST
MERCEDES-BENZ cont.					
ACTROS MP2 5041 AK	06/2008 -	B 180 APC	B 180 EHD	B 185 APC	
ACTROS MP2 5041 B	06/2008 -	B 180 APC	B 180 EHD	B 185 APC	
ACTROS MP2 5041 K	06/2008 -	B 180 APC	B 180 EHD	B 185 APC	
ACTROS MP2 5044 AK	06/2008 -	B 180 APC	B 180 EHD	B 185 APC	
ACTROS MP2 5044 B	06/2008 -	B 180 APC	B 180 EHD	B 185 APC	
ACTROS MP2 5044 K	06/2008 -	B 180 APC	B 180 EHD	B 185 APC	
ACTROS MP2 5046 AK	06/2008 -	B 180 APC	B 180 EHD	B 185 APC	
ACTROS MP2 5046 B	06/2008 -	B 180 APC	B 180 EHD	B 185 APC	
ACTROS MP2 5046 K	06/2008 -	B 180 APC	B 180 EHD	B 185 APC	
ACTROS MP2 5048 AK	06/2008 -	B 180 APC	B 180 EHD	B 185 APC	
ACTROS MP4 1824 L	07/2011 -	B 180 APC	B 180 EHD	B 185 APC	
ACTROS MP4 1824 LS		B 180 APC	B 180 EHD	B 185 APC	
ACTROS MP4 1827 L	07/2011 -	B 180 APC	B 180 EHD	B 185 APC	
ACTROS MP4 1827 LS		B 180 APC	B 180 EHD	B 185 APC	
ACTROS MP4 1830 L	07/2011 -	B 180 APC	B 180 EHD	B 185 APC	
ACTROS MP4 1830 LS		B 180 APC	B 180 EHD	B 185 APC	
ACTROS MP4 1832 L	07/2011 -	B 180 APC	B 180 EHD	B 185 APC	
ACTROS MP4 1832 LS		B 180 APC	B 180 EHD	B 185 APC	
ACTROS MP4 1833 L	07/2011 -	B 180 APC	B 180 EHD	B 185 APC	
ACTROS MP4 1833 LS	07/2011 -	B 180 APC	B 180 EHD	B 185 APC	
ACTROS MP4 1835 L	07/2011 -	B 180 APC	B 180 EHD	B 185 APC	
ACTROS MP4 1835 LS	07/2011 -	B 180 APC	B 180 EHD	B 185 APC	
ACTROS MP4 1836 L	07/2011 -	B 180 APC	B 180 EHD	B 185 APC	
ACTROS MP4 1836 LS	07/2011 -	B 180 APC	B 180 EHD	B 185 APC	
ACTROS MP4 1840 L	07/2011 -	B 180 APC	B 180 EHD	B 185 APC	
ACTROS MP4 1840 LS	07/2011 -	B 180 APC	B 180 EHD	B 185 APC	
ACTROS MP4 1843 L	07/2011 -	B 180 APC	B 180 EHD	B 185 APC	
ACTROS MP4 1843 LS	07/2011 -	B 180 APC	B 180 EHD	B 185 APC	
ACTROS MP4 1845 L	07/2011 -	B 180 APC	B 180 EHD	B 185 APC	
ACTROS MP4 1845 LS	07/2011 -	B 180 APC	B 180 EHD	B 185 APC	
ACTROS MP4 1848 L	07/2011 -	B 180 APC	B 180 EHD	B 185 APC	
ACTROS MP4 1848 LS	07/2011 -	B 180 APC	B 180 EHD	B 185 APC	
ACTROS MP4 1851 L	07/2011 -	B 180 APC	B 180 EHD	B 185 APC	
ACTROS MP4 1851 LS	07/2011 -	B 180 APC	B 180 EHD	B 185 APC	
ACTROS MP4 2024 L	07/2011 -	B 180 APC	B 180 EHD	B 185 APC	
ACTROS MP4 2024 LS	07/2011 -	B 180 APC	B 180 EHD	B 185 APC	
ACTROS MP4 2027 L	07/2011 -	B 180 APC	B 180 EHD	B 185 APC	
ACTROS MP4 2027 LS	07/2011 -	B 180 APC	B 180 EHD	B 185 APC	
ACTROS MP4 2030 L	07/2011 -	B 180 APC	B 180 EHD	B 185 APC	
ACTROS MP4 2030 LS	07/2011 -	B 180 APC	B 180 EHD	B 185 APC	
ACTROS MP4 2032 L	07/2011 -	B 180 APC	B 180 EHD	B 185 APC	
ACTROS MP4 2032 LS	07/2011 -	B 180 APC	B 180 EHD	B 185 APC	
ACTROS MP4 2033 L	07/2011 -	B 180 APC	B 180 EHD	B 185 APC	
ACTROS MP4 2033 LS	07/2011 -	B 180 APC	B 180 EHD	B 185 APC	
ACTROS MP4 2035 L	07/2011 -	B 180 APC	B 180 EHD	B 185 APC	

MARCHIO E MODELLO - MAKE AND MODEL MARQUE ET MODÈLE - MARKE UND MODELL MARCA Y MODELO - МАРКА И МОДЕЛЬ	Periodo Period	powerCUBE		energyCUBE	
		APC	EHD	APC	RST
MERCEDES-BENZ cont.					
ACTROS MP4 2035 LS	07/2011 -	B 180 APC	B 180 EHD	B 185 APC	
ACTROS MP4 2036 L	07/2011 -	B 180 APC	B 180 EHD	B 185 APC	
ACTROS MP4 2036 LS	07/2011 -	B 180 APC	B 180 EHD	B 185 APC	
ACTROS MP4 2040 L	07/2011 -	B 180 APC	B 180 EHD	B 185 APC	
ACTROS MP4 2040 LS	07/2011 -	B 180 APC	B 180 EHD	B 185 APC	
ACTROS MP4 2042 L	07/2011 -	B 180 APC	B 180 EHD	B 185 APC	
ACTROS MP4 2042 LS	07/2011 -	B 180 APC	B 180 EHD	B 185 APC	
ACTROS MP4 2043 L	07/2011 -	B 180 APC	B 180 EHD	B 185 APC	
ACTROS MP4 2043 LS	07/2011 -	B 180 APC	B 180 EHD	B 185 APC	
ACTROS MP4 2045 L	07/2011 -	B 180 APC	B 180 EHD	B 185 APC	
ACTROS MP4 2045 LS	07/2011 -	CX 225 APC		CX 220 APC	
ACTROS MP4 2048 L	07/2011 -	B 180 APC	B 180 EHD	B 185 APC	
ACTROS MP4 2048 LS	07/2011 -	B 180 APC	B 180 EHD	B 185 APC	
ACTROS MP4 2051 L	07/2011 -	B 180 APC	B 180 EHD	B 185 APC	
ACTROS MP4 2051 LS	07/2011 -	B 180 APC	B 180 EHD	B 185 APC	
ACTROS MP4 2427 LS	07/2011 -	B 180 APC	B 180 EHD	B 185 APC	
ACTROS MP4 2430 LS	07/2011 -	B 180 APC	B 180 EHD	B 185 APC	
ACTROS MP4 2432 LS	07/2011 -	B 180 APC	B 180 EHD	B 185 APC	
ACTROS MP4 2433 LS	07/2011 -	B 180 APC	B 180 EHD	B 185 APC	
ACTROS MP4 2435 LS	07/2011 -	B 180 APC	B 180 EHD	B 185 APC	
ACTROS MP4 2436 LS	07/2011 -	B 180 APC	B 180 EHD	B 185 APC	
ACTROS MP4 2440 LS	07/2011 -	B 180 APC	B 180 EHD	B 185 APC	
ACTROS MP4 2442 LS	07/2011 -	B 180 APC	B 180 EHD	B 185 APC	
ACTROS MP4 2443 LS	07/2011 -	B 180 APC	B 180 EHD	B 185 APC	
ACTROS MP4 2445 LS	07/2011 -	B 180 APC	B 180 EHD	B 185 APC	
ACTROS MP4 2448 LS	07/2011 -	B 180 APC	B 180 EHD	B 185 APC	
ACTROS MP4 2451 LS	07/2011 -	B 180 APC	B 180 EHD	B 185 APC	
ACTROS MP4 2527 L	07/2011 -	B 180 APC	B 180 EHD	B 185 APC	
ACTROS MP4 2527 LS	07/2011 -	B 180 APC	B 180 EHD	B 185 APC	
ACTROS MP4 2530 L	07/2011 -	B 180 APC	B 180 EHD	B 185 APC	
ACTROS MP4 2530 LS	07/2011 -	B 180 APC	B 180 EHD	B 185 APC	
ACTROS MP4 2532 L	07/2011 -	B 180 APC	B 180 EHD	B 185 APC	
ACTROS MP4 2532 LS	07/2011 -	B 180 APC	B 180 EHD	B 185 APC	
ACTROS MP4 2533 L	07/2011 -	B 180 APC	B 180 EHD	B 185 APC	
ACTROS MP4 2533 LS	07/2011 -	B 180 APC	B 180 EHD	B 185 APC	
ACTROS MP4 2535 L	07/2011 -	B 180 APC	B 180 EHD	B 185 APC	
ACTROS MP4 2535 LS	07/2011 -	B 180 APC	B 180 EHD	B 185 APC	
ACTROS MP4 2536 L	07/2011 -	B 180 APC	B 180 EHD	B 185 APC	
ACTROS MP4 2536 LS	07/2011 -	B 180 APC	B 180 EHD	B 185 APC	
ACTROS MP4 2540 L	07/2011 -	B 180 APC	B 180 EHD	B 185 APC	
ACTROS MP4 2540 LS	07/2011 -	B 180 APC	B 180 EHD	B 185 APC	
ACTROS MP4 2542 LS	07/2011 -	B 180 APC	B 180 EHD	B 185 APC	
ACTROS MP4 2543 L	07/2011 -	B 180 APC	B 180 EHD	B 185 APC	
ACTROS MP4 2543 LS	07/2011 -	B 180 APC	B 180 EHD	B 185 APC	
ACTROS MP4 2545 L	07/2011 -	B 180 APC	B 180 EHD	B 185 APC	

MARCHIO E MODELLO - MAKE AND MODEL MARQUE ET MODÈLE - MARKE UND MODELL MARCA Y MODELO - МАРКА И МОДЕЛЬ	Periodo Period	powerCUBE		energyCUBE	
		APC	EHD	APC	RST
MERCEDES-BENZ cont.					
ACTROS MP4 2545 LS	07/2011 -	B 180 APC	B 180 EHD	B 185 APC	
ACTROS MP4 2548 L	07/2011 -	B 180 APC	B 180 EHD	B 185 APC	
ACTROS MP4 2548 LS	07/2011 -	B 180 APC	B 180 EHD	B 185 APC	
ACTROS MP4 2551 L	07/2011 -	B 180 APC	B 180 EHD	B 185 APC	
ACTROS MP4 2551 LS	07/2011 -	B 180 APC	B 180 EHD	B 185 APC	
ACTROS MP4 2627 L	07/2011 -	B 180 APC	B 180 EHD	B 185 APC	
ACTROS MP4 2627 LS	07/2011 -	B 180 APC	B 180 EHD	B 185 APC	
ACTROS MP4 2630 L	07/2011 -	B 180 APC	B 180 EHD	B 185 APC	
ACTROS MP4 2630 LS	07/2011 -	B 180 APC	B 180 EHD	B 185 APC	
ACTROS MP4 2632 L	07/2011 -	B 180 APC	B 180 EHD	B 185 APC	
ACTROS MP4 2632 LS	07/2011 -	B 180 APC	B 180 EHD	B 185 APC	
ACTROS MP4 2633 L	07/2011 -	B 180 APC	B 180 EHD	B 185 APC	
ACTROS MP4 2633 LS	07/2011 -	B 180 APC	B 180 EHD	B 185 APC	
ACTROS MP4 2635 L	07/2011 -	B 180 APC	B 180 EHD	B 185 APC	
ACTROS MP4 2635 LS	07/2011 -	B 180 APC	B 180 EHD	B 185 APC	
ACTROS MP4 2636 L	07/2011 -	B 180 APC	B 180 EHD	B 185 APC	
ACTROS MP4 2636 LS	07/2011 -	B 180 APC	B 180 EHD	B 185 APC	
ACTROS MP4 2640 L	07/2011 -	B 180 APC	B 180 EHD	B 185 APC	
ACTROS MP4 2640 LS	07/2011 -	B 180 APC	B 180 EHD	B 185 APC	
ACTROS MP4 2642 L	07/2011 -	B 180 APC	B 180 EHD	B 185 APC	
ACTROS MP4 2642 LS	07/2011 -	B 180 APC	B 180 EHD	B 185 APC	
ACTROS MP4 2643 L	07/2011 -	B 180 APC	B 180 EHD	B 185 APC	
ACTROS MP4 2643 LS	07/2011 -	B 180 APC	B 180 EHD	B 185 APC	
ACTROS MP4 2645 L	07/2011 -	B 180 APC	B 180 EHD	B 185 APC	
ACTROS MP4 2645 LS	07/2011 -	B 180 APC	B 180 EHD	B 185 APC	
ACTROS MP4 2648 L	07/2011 -	B 180 APC	B 180 EHD	B 185 APC	
ACTROS MP4 2648 LS	07/2011 -	B 180 APC	B 180 EHD	B 185 APC	
ACTROS MP4 2651 L	07/2011 -	B 180 APC	B 180 EHD	B 185 APC	
ACTROS MP4 2651 LS	07/2011 -	B 180 APC	B 180 EHD	B 185 APC	
ACTROS MP4 3333 L	07/2011 -	B 180 APC	B 180 EHD	B 185 APC	
ACTROS MP4 3333 LS	07/2011 -	B 180 APC	B 180 EHD	B 185 APC	
ACTROS MP4 3336 L	07/2011 -	B 180 APC	B 180 EHD	B 185 APC	
ACTROS MP4 3336 LS	07/2011 -	B 180 APC	B 180 EHD	B 185 APC	
ACTROS MP4 3340 L	07/2011 -	B 180 APC	B 180 EHD	B 185 APC	
ACTROS MP4 3340 LS	07/2011 -	B 180 APC	B 180 EHD	B 185 APC	
ACTROS MP4 3342 L	07/2011 -	B 180 APC	B 180 EHD	B 185 APC	
ACTROS MP4 3342 LS	07/2011 -	B 180 APC	B 180 EHD	B 185 APC	
ACTROS MP4 3343 L	07/2011 -	B 180 APC	B 180 EHD	B 185 APC	
ACTROS MP4 3343 LS	07/2011 -	B 180 APC	B 180 EHD	B 185 APC	
ACTROS MP4 3345 L	07/2011 -	B 180 APC	B 180 EHD	B 185 APC	
ACTROS MP4 3345 LS	07/2011 -	B 180 APC	B 180 EHD	B 185 APC	
ACTROS MP4 3348 L	07/2011 -	B 180 APC	B 180 EHD	B 185 APC	
ACTROS MP4 3348 LS	07/2011 -	B 180 APC	B 180 EHD	B 185 APC	
ACTROS MP4 3351 L	07/2011 -	B 180 APC	B 180 EHD	B 185 APC	
ACTROS MP4 3351 LS	07/2011 -	B 180 APC	B 180 EHD	B 185 APC	

MARCHIO E MODELLO - MAKE AND MODEL MARQUE ET MODÈLE - MARKE UND MODELL MARCA Y MODELO - МАРКА И МОДЕЛЬ	Periodo Period	powerCUBE		energyCUBE	
		APC	EHD	APC	RST
MERCEDES-BENZ cont.					
ANTOS 1824 L	07/2012 -	B 180 APC	B 180 EHD	B 185 APC	
ANTOS 1824 LS	07/2012 -	B 180 APC	B 180 EHD	B 185 APC	
ANTOS 1827 L	07/2012 -	B 180 APC	B 180 EHD	B 185 APC	
ANTOS 1827 LS	07/2012 -	B 180 APC	B 180 EHD	B 185 APC	
ANTOS 1830 L	07/2012 -	B 180 APC	B 180 EHD	B 185 APC	
ANTOS 1830 LS	07/2012 -	B 180 APC	B 180 EHD	B 185 APC	
ANTOS 1832 L	07/2012 -	B 180 APC	B 180 EHD	B 185 APC	
ANTOS 1832 LS	07/2012 -	B 180 APC	B 180 EHD	B 185 APC	
ANTOS 1833 L	07/2012 -	B 180 APC	B 180 EHD	B 185 APC	
ANTOS 1833 LS	07/2012 -	B 180 APC	B 180 EHD	B 185 APC	
ANTOS 1835 L	07/2012 -	B 180 APC	B 180 EHD	B 185 APC	
ANTOS 1835 LS	07/2012 -	B 180 APC	B 180 EHD	B 185 APC	
ANTOS 1836 L	07/2012 -	B 180 APC	B 180 EHD	B 185 APC	
ANTOS 1836 LS	07/2012 -	B 180 APC	B 180 EHD	B 185 APC	
ANTOS 1840 L	07/2012 -	B 180 APC	B 180 EHD	B 185 APC	
ANTOS 1840 LS	07/2012 -	B 180 APC	B 180 EHD	B 185 APC	
ANTOS 1842 L	07/2012 -	B 180 APC	B 180 EHD	B 185 APC	
ANTOS 1842 LS	07/2012 -	B 180 APC	B 180 EHD	B 185 APC	
ANTOS 1843 L	07/2012 -	B 180 APC	B 180 EHD	B 185 APC	
ANTOS 1843 LS	07/2012 -	B 180 APC	B 180 EHD	B 185 APC	
ANTOS 1845 L	07/2012 -	B 180 APC	B 180 EHD	B 185 APC	
ANTOS 1845 LS	07/2012 -	B 180 APC	B 180 EHD	B 185 APC	
ANTOS 1848 L	07/2012 -	B 180 APC	B 180 EHD	B 185 APC	
ANTOS 1848 LS	07/2012 -	B 180 APC	B 180 EHD	B 185 APC	
ANTOS 1851 L	07/2012 -	B 180 APC	B 180 EHD	B 185 APC	
ANTOS 1851 LS	07/2012 -	B 180 APC	B 180 EHD	B 185 APC	
ANTOS 2024 L	07/2012 -	B 180 APC	B 180 EHD	B 185 APC	
ANTOS 2024 LS	07/2012 -	B 180 APC	B 180 EHD	B 185 APC	
ANTOS 2027 L	07/2012 -	B 180 APC	B 180 EHD	B 185 APC	
ANTOS 2027 LS	07/2012 -	B 180 APC	B 180 EHD	B 185 APC	
ANTOS 2030 L	07/2012 -	B 180 APC	B 180 EHD	B 185 APC	
ANTOS 2030 LS	07/2012 -	B 180 APC	B 180 EHD	B 185 APC	
ANTOS 2032 L	07/2012 -	B 180 APC	B 180 EHD	B 185 APC	
ANTOS 2032 LS	07/2012 -	B 180 APC	B 180 EHD	B 185 APC	
ANTOS 2033 L	07/2012 -	B 180 APC	B 180 EHD	B 185 APC	
ANTOS 2033 LS	07/2012 -	B 180 APC	B 180 EHD	B 185 APC	
ANTOS 2035 L	07/2012 -	B 180 APC	B 180 EHD	B 185 APC	
ANTOS 2035 LS	07/2012 -	B 180 APC	B 180 EHD	B 185 APC	
ANTOS 2036 L	07/2012 -	B 180 APC	B 180 EHD	B 185 APC	
ANTOS 2036 LS	07/2012 -	B 180 APC	B 180 EHD	B 185 APC	
ANTOS 2040 L	07/2012 -	B 180 APC	B 180 EHD	B 185 APC	
ANTOS 2040 LS	07/2012 -	B 180 APC	B 180 EHD	B 185 APC	
ANTOS 2042 L	07/2012 -	B 180 APC	B 180 EHD	B 185 APC	
ANTOS 2042 LS	07/2012 -	B 180 APC	B 180 EHD	B 185 APC	
ANTOS 2043 L	07/2012 -	B 180 APC	B 180 EHD	B 185 APC	

MARCHIO E MODELLO - MAKE AND MODEL MARQUE ET MODÈLE - MARKE UND MODELL MARCA Y MODELO - МАРКА И МОДЕЛЬ	Periodo Period	powerCUBE		energyCUBE	
		APC	EHD	APC	RST
MERCEDES-BENZ cont.					
ANTOS 2043 LS	07/2012 -	B 180 APC	B 180 EHD	B 185 APC	
ANTOS 2045 L	07/2012 -	B 180 APC	B 180 EHD	B 185 APC	
ANTOS 2045 LS	07/2012 -	B 180 APC	B 180 EHD	B 185 APC	
ANTOS 2048 L	07/2012 -	B 180 APC	B 180 EHD	B 185 APC	
ANTOS 2048 LS	07/2012 -	B 180 APC	B 180 EHD	B 185 APC	
ANTOS 2051 L	07/2012 -	B 180 APC	B 180 EHD	B 185 APC	
ANTOS 2051 LS	07/2012 -	B 180 APC	B 180 EHD	B 185 APC	
ANTOS 2427 LS	07/2012 -	B 180 APC	B 180 EHD	B 185 APC	
ANTOS 2430 LS	07/2012 -	B 180 APC	B 180 EHD	B 185 APC	
ANTOS 2432 LS	07/2012 -	B 180 APC	B 180 EHD	B 185 APC	
ANTOS 2433 LS	07/2012 -	B 180 APC	B 180 EHD	B 185 APC	
ANTOS 2435 LS	07/2012 -	B 180 APC	B 180 EHD	B 185 APC	
ANTOS 2436 LS	07/2012 -	B 180 APC	B 180 EHD	B 185 APC	
ANTOS 2440 LS	07/2012 -	B 180 APC	B 180 EHD	B 185 APC	
ANTOS 2442 LS	07/2012 -	B 180 APC	B 180 EHD	B 185 APC	
ANTOS 2443 LS	07/2012 -	B 180 APC	B 180 EHD	B 185 APC	
ANTOS 2445 LS	07/2012 -	B 180 APC	B 180 EHD	B 185 APC	
ANTOS 2448 LS	07/2012 -	B 180 APC	B 180 EHD	B 185 APC	
ANTOS 2451 LS	07/2012 -	B 180 APC	B 180 EHD	B 185 APC	
ANTOS 2527 L	07/2012 -	B 180 APC	B 180 EHD	B 185 APC	
ANTOS 2527 LS	07/2012 -	B 180 APC	B 180 EHD	B 185 APC	
ANTOS 2530 L	07/2012 -	B 180 APC	B 180 EHD	B 185 APC	
ANTOS 2530 LS	07/2012 -	B 180 APC	B 180 EHD	B 185 APC	
ANTOS 2532 L	07/2012 -	B 180 APC	B 180 EHD	B 185 APC	
ANTOS 2532 LS	07/2012 -	B 180 APC	B 180 EHD	B 185 APC	
ANTOS 2533 L	07/2012 -	B 180 APC	B 180 EHD	B 185 APC	
ANTOS 2533 LS	07/2012 -	B 180 APC	B 180 EHD	B 185 APC	
ANTOS 2535 L	07/2012 -	B 180 APC	B 180 EHD	B 185 APC	
ANTOS 2535 LS	07/2012 -	B 180 APC	B 180 EHD	B 185 APC	
ANTOS 2536 L	07/2012 -	B 180 APC	B 180 EHD	B 185 APC	
ANTOS 2536 LS	07/2012 -	B 180 APC	B 180 EHD	B 185 APC	
ANTOS 2540 L	07/2012 -	B 180 APC	B 180 EHD	B 185 APC	
ANTOS 2540 LS	07/2012 -	B 180 APC	B 180 EHD	B 185 APC	
ANTOS 2542 L	07/2012 -	B 180 APC	B 180 EHD	B 185 APC	
ANTOS 2542 LS	07/2012 -	B 180 APC	B 180 EHD	B 185 APC	
ANTOS 2543 L	07/2012 -	B 180 APC	B 180 EHD	B 185 APC	
ANTOS 2543 LS	07/2012 -	B 180 APC	B 180 EHD	B 185 APC	
ANTOS 2545 L	07/2012 -	B 180 APC	B 180 EHD	B 185 APC	
ANTOS 2545 LS	07/2012 -	B 180 APC	B 180 EHD	B 185 APC	
ANTOS 2548 L	07/2012 -	B 180 APC	B 180 EHD	B 185 APC	
ANTOS 2548 LS	07/2012 -	B 180 APC	B 180 EHD	B 185 APC	
ANTOS 2551 L	07/2012 -	B 180 APC	B 180 EHD	B 185 APC	
ANTOS 2551 LS	07/2012 -	B 180 APC	B 180 EHD	B 185 APC	
ANTOS 2627 L	07/2012 -	B 180 APC	B 180 EHD	B 185 APC	
ANTOS 2627 LS	07/2012 -	B 180 APC	B 180 EHD	B 185 APC	

MARCHIO E MODELLO - MAKE AND MODEL MARQUE ET MODÈLE - MARKE UND MODELL MARCA Y MODELO - МАРКА И МОДЕЛЬ	Periodo Period	powerCUBE		energyCUBE	
		APC	EHD	APC	RST
MERCEDES-BENZ cont.					
ANTOS 2630 L	07/2012 -	B 180 APC	B 180 EHD	B 185 APC	
ANTOS 2630 LS	07/2012 -	B 180 APC	B 180 EHD	B 185 APC	
ANTOS 2632 L	07/2012 -	B 180 APC	B 180 EHD	B 185 APC	
ANTOS 2632 LS	07/2012 -	B 180 APC	B 180 EHD	B 185 APC	
ANTOS 2633 L	07/2012 -	B 180 APC	B 180 EHD	B 185 APC	
ANTOS 2633 LS	07/2012 -	B 180 APC	B 180 EHD	B 185 APC	
ANTOS 2635 L	07/2012 -	B 180 APC	B 180 EHD	B 185 APC	
ANTOS 2635 LS	07/2012 -	B 180 APC	B 180 EHD	B 185 APC	
ANTOS 2636 L	07/2012 -	B 180 APC	B 180 EHD	B 185 APC	
ANTOS 2636 LS	07/2012 -	B 180 APC	B 180 EHD	B 185 APC	
ANTOS 2640 L	07/2012 -	B 180 APC	B 180 EHD	B 185 APC	
ANTOS 2640 LS	07/2012 -	B 180 APC	B 180 EHD	B 185 APC	
ANTOS 2642 L	07/2012 -	B 180 APC	B 180 EHD	B 185 APC	
ANTOS 2642 LS	07/2012 -	B 180 APC	B 180 EHD	B 185 APC	
ANTOS 2643 L	07/2012 -	B 180 APC	B 180 EHD	B 185 APC	
ANTOS 2643 LS	07/2012 -	B 180 APC	B 180 EHD	B 185 APC	
ANTOS 2645 L	07/2012 -	B 180 APC	B 180 EHD	B 185 APC	
ANTOS 2645 LS	07/2012 -	B 180 APC	B 180 EHD	B 185 APC	
ANTOS 2648 L	07/2012 -	B 180 APC	B 180 EHD	B 185 APC	
ANTOS 2648 LS	07/2012 -	B 180 APC	B 180 EHD	B 185 APC	
ANTOS 2651 L	07/2012 -	B 180 APC	B 180 EHD	B 185 APC	
ANTOS 2651 LS	07/2012 -	B 180 APC	B 180 EHD	B 185 APC	
ANTOS 3333 L	07/2012 -	B 180 APC	B 180 EHD	B 185 APC	
ANTOS 3333 LS	07/2012 -	B 180 APC	B 180 EHD	B 185 APC	
ANTOS 3336 L	07/2012 -	B 180 APC	B 180 EHD	B 185 APC	
ANTOS 3336 LS	07/2012 -	B 180 APC	B 180 EHD	B 185 APC	
ANTOS 3340 L	07/2012 -	B 180 APC	B 180 EHD	B 185 APC	
ANTOS 3340 LS	07/2012 -	B 180 APC	B 180 EHD	B 185 APC	
ANTOS 3342 L	07/2012 -	B 180 APC	B 180 EHD	B 185 APC	
ANTOS 3342 LS	07/2012 -	B 180 APC	B 180 EHD	B 185 APC	
ANTOS 3343 L	07/2012 -	B 180 APC	B 180 EHD	B 185 APC	
ANTOS 3343 LS	07/2012 -	B 180 APC	B 180 EHD	B 185 APC	
ANTOS 3345 L	07/2012 -	B 180 APC	B 180 EHD	B 185 APC	
ANTOS 3345 LS	07/2012 -	B 180 APC	B 180 EHD	B 185 APC	
ANTOS 3348 L	07/2012 -	B 180 APC	B 180 EHD	B 185 APC	
ANTOS 3348 LS	07/2012 -	B 180 APC	B 180 EHD	B 185 APC	
ANTOS 3351 L	07/2012 -	B 180 APC	B 180 EHD	B 185 APC	
ANTOS 3351 LS	07/2012 -	B 180 APC	B 180 EHD	B 185 APC	
AROCS 1824	01/2013 -	B 180 APC	B 180 EHD	B 185 APC	
AROCS 1824 A	01/2013 -	B 180 APC	B 180 EHD	B 185 APC	
AROCS 1824 AK	01/2013 -	B 180 APC	B 180 EHD	B 185 APC	
AROCS 1824 K	01/2013 -	B 180 APC	B 180 EHD	B 185 APC	
AROCS 1824 LS	01/2013 -	B 180 APC	B 180 EHD	B 185 APC	
AROCS 1827	01/2013 -	B 180 APC	B 180 EHD	B 185 APC	
AROCS 1827 A	01/2013 -	B 180 APC	B 180 EHD	B 185 APC	

MARCHIO E MODELLO - MAKE AND MODEL MARQUE ET MODÈLE - MARKE UND MODELL MARCA Y MODELO - МАРКА И МОДЕЛЬ	Periodo Period	powerCUBE		energyCUBE	
		APC	EHD	APC	RST
MERCEDES-BENZ cont.					
AROCS 1827 AK	01/2013 -	B 180 APC	B 180 EHD	B 185 APC	
AROCS 1827 K	01/2013 -	B 180 APC	B 180 EHD	B 185 APC	
AROCS 1827 LS	01/2013 -	B 180 APC	B 180 EHD	B 185 APC	
AROCS 1830	01/2013 -	B 180 APC	B 180 EHD	B 185 APC	
AROCS 1830 A	01/2013 -	B 180 APC	B 180 EHD	B 185 APC	
AROCS 1830 AK	01/2013 -	B 180 APC	B 180 EHD	B 185 APC	
AROCS 1830 K	01/2013 -	B 180 APC	B 180 EHD	B 185 APC	
AROCS 1830 S, 1830 LS	01/2013 -	B 180 APC	B 180 EHD	B 185 APC	
AROCS 1832	01/2013 -	B 180 APC	B 180 EHD	B 185 APC	
AROCS 1832 A	01/2013 -	B 180 APC	B 180 EHD	B 185 APC	
AROCS 1832 AK	01/2013 -	B 180 APC	B 180 EHD	B 185 APC	
AROCS 1832 K	01/2013 -	B 180 APC	B 180 EHD	B 185 APC	
AROCS 1832 S, 1832 LS	01/2013 -	B 180 APC	B 180 EHD	B 185 APC	
AROCS 1833	01/2013 -	B 180 APC	B 180 EHD	B 185 APC	
AROCS 1833 A	01/2013 -	B 180 APC	B 180 EHD	B 185 APC	
AROCS 1833 AK	01/2013 -	B 180 APC	B 180 EHD	B 185 APC	
AROCS 1833 AS	01/2013 -	B 180 APC	B 180 EHD	B 185 APC	
AROCS 1833 K	01/2013 -	B 180 APC	B 180 EHD	B 185 APC	
AROCS 1833 LS	01/2013 -	B 180 APC	B 180 EHD	B 185 APC	
AROCS 1835	01/2013 -	B 180 APC	B 180 EHD	B 185 APC	
AROCS 1835 A	01/2013 -	B 180 APC	B 180 EHD	B 185 APC	
AROCS 1835 AK	01/2013 -	B 180 APC	B 180 EHD	B 185 APC	
AROCS 1835 K	01/2013 -	B 180 APC	B 180 EHD	B 185 APC	
AROCS 1835 S, 1835 LS	01/2013 -	B 180 APC	B 180 EHD	B 185 APC	
AROCS 1836	01/2013 -	B 180 APC	B 180 EHD	B 185 APC	
AROCS 1836 A	01/2013 -	B 180 APC	B 180 EHD	B 185 APC	
AROCS 1836 AK	01/2013 -	B 180 APC	B 180 EHD	B 185 APC	
AROCS 1836 AS	01/2013 -	B 180 APC	B 180 EHD	B 185 APC	
AROCS 1836 K	01/2013 -	B 180 APC	B 180 EHD	B 185 APC	
AROCS 1836 S, 1836 LS	01/2013 -	B 180 APC	B 180 EHD	B 185 APC	
AROCS 1840	01/2013 -	B 180 APC	B 180 EHD	B 185 APC	
AROCS 1840 A	01/2013 -	B 180 APC	B 180 EHD	B 185 APC	
AROCS 1840 AK	01/2013 -	B 180 APC	B 180 EHD	B 185 APC	
AROCS 1840 AS	01/2013 -	B 180 APC	B 180 EHD	B 185 APC	
AROCS 1840 K	01/2013 -	B 180 APC	B 180 EHD	B 185 APC	
AROCS 1840 LS	01/2013 -	B 180 APC	B 180 EHD	B 185 APC	
AROCS 1842	01/2013 -	B 180 APC	B 180 EHD	B 185 APC	
AROCS 1842 A	01/2013 -	B 180 APC	B 180 EHD	B 185 APC	
AROCS 1842 AK	01/2013 -	B 180 APC	B 180 EHD	B 185 APC	
AROCS 1842 AS	01/2013 -	B 180 APC	B 180 EHD	B 185 APC	
AROCS 1842 K	01/2013 -	B 180 APC	B 180 EHD	B 185 APC	
AROCS 1842 LS	01/2013 -	B 180 APC	B 180 EHD	B 185 APC	
AROCS 1843	01/2013 -	B 180 APC	B 180 EHD	B 185 APC	
AROCS 1843 A	01/2013 -	B 180 APC	B 180 EHD	B 185 APC	
AROCS 1843 AK	01/2013 -	B 180 APC	B 180 EHD	B 185 APC	

MARCHIO E MODELLO - MAKE AND MODEL MARQUE ET MODÈLE - MARKE UND MODELL MARCA Y MODELO - МАРКА И МОДЕЛЬ	Periodo Period	powerCUBE		energyCUBE	
		APC	EHD	APC	RST
MERCEDES-BENZ cont.					
AROCS 1843 AS	01/2013 -	B 180 APC	B 180 EHD	B 185 APC	
AROCS 1843 K	01/2013 -	B 180 APC	B 180 EHD	B 185 APC	
AROCS 1843 LS	01/2013 -	B 180 APC	B 180 EHD	B 185 APC	
AROCS 1845	01/2013 -	B 180 APC	B 180 EHD	B 185 APC	
AROCS 1845 A	01/2013 -	B 180 APC	B 180 EHD	B 185 APC	
AROCS 1845 AK	01/2013 -	B 180 APC	B 180 EHD	B 185 APC	
AROCS 1845 AS	01/2013 -	B 180 APC	B 180 EHD	B 185 APC	
AROCS 1845 K	01/2013 -	B 180 APC	B 180 EHD	B 185 APC	
AROCS 1845 LS	01/2013 -	B 180 APC	B 180 EHD	B 185 APC	
AROCS 1848	01/2013 -	B 180 APC	B 180 EHD	B 185 APC	
AROCS 1848 A	01/2013 -	B 180 APC	B 180 EHD	B 185 APC	
AROCS 1848 AK	01/2013 -	B 180 APC	B 180 EHD	B 185 APC	
AROCS 1848 AS	01/2013 -	B 180 APC	B 180 EHD	B 185 APC	
AROCS 1848 K	01/2013 -	B 180 APC	B 180 EHD	B 185 APC	
AROCS 1848 LS	01/2013 -	B 180 APC	B 180 EHD	B 185 APC	
AROCS 1851	01/2013 -	B 180 APC	B 180 EHD	B 185 APC	
AROCS 1851 A	01/2013 -	CX 225 APC		CX 220 APC	
AROCS 1851 AK	01/2013 -	B 180 APC	B 180 EHD	B 185 APC	
AROCS 1851 AS	01/2013 -	B 180 APC	B 180 EHD	B 185 APC	
AROCS 1851 K	01/2013 -	B 180 APC	B 180 EHD	B 185 APC	
AROCS 1851 LS	01/2013 -	B 180 APC	B 180 EHD	B 185 APC	
AROCS 2024	01/2013 -	B 180 APC	B 180 EHD	B 185 APC	
AROCS 2024 K	01/2013 -	B 180 APC	B 180 EHD	B 185 APC	
AROCS 2024 S, 2424 LS	01/2013 -	B 180 APC	B 180 EHD	B 185 APC	
AROCS 2027	01/2013 -	B 180 APC	B 180 EHD	B 185 APC	
AROCS 2027 K	01/2013 -	B 180 APC	B 180 EHD	B 185 APC	
AROCS 2027 S, 2027 LS	01/2013 -	B 180 APC	B 180 EHD	B 185 APC	
AROCS 2030	01/2013 -	B 180 APC	B 180 EHD	B 185 APC	
AROCS 2030 K	01/2013 -	B 180 APC	B 180 EHD	B 185 APC	
AROCS 2030 S, 2030 LS	01/2013 -	B 180 APC	B 180 EHD	B 185 APC	
AROCS 2032	01/2013 -	B 180 APC	B 180 EHD	B 185 APC	
AROCS 2032 K	01/2013 -	B 180 APC	B 180 EHD	B 185 APC	
AROCS 2032 S, 2032 LS	01/2013 -	B 180 APC	B 180 EHD	B 185 APC	
AROCS 2033	01/2013 -	B 180 APC	B 180 EHD	B 185 APC	
AROCS 2033 A	01/2013 -	B 180 APC	B 180 EHD	B 185 APC	
AROCS 2033 AK	01/2013 -	B 180 APC	B 180 EHD	B 185 APC	
AROCS 2033 AS	01/2013 -	B 180 APC	B 180 EHD	B 185 APC	
AROCS 2033 K	01/2013 -	B 180 APC	B 180 EHD	B 185 APC	
AROCS 2033 S, 2033 LS	01/2013 -	B 180 APC	B 180 EHD	B 185 APC	
AROCS 2035	01/2013 -	B 180 APC	B 180 EHD	B 185 APC	
AROCS 2035 K	01/2013 -	B 180 APC	B 180 EHD	B 185 APC	
AROCS 2035 S, 2035 LS	01/2013 -	B 180 APC	B 180 EHD	B 185 APC	
AROCS 2036	01/2013 -	B 180 APC	B 180 EHD	B 185 APC	
AROCS 2036 A	01/2013 -	B 180 APC	B 180 EHD	B 185 APC	
AROCS 2036 AK	01/2013 -	B 180 APC	B 180 EHD	B 185 APC	

MARCHIO E MODELLO - MAKE AND MODEL MARQUE ET MODÈLE - MARKE UND MODELL MARCA Y MODELO - МАРКА И МОДЕЛЬ	Periodo Period	powerCUBE		energyCUBE	
		APC	EHD	APC	RST
MERCEDES-BENZ cont.					
AROCS 2036 AS	01/2013 -	B 180 APC	B 180 EHD	B 185 APC	
AROCS 2036 K	01/2013 -	B 180 APC	B 180 EHD	B 185 APC	
AROCS 2036 S, 2036 LS	01/2013 -	B 180 APC	B 180 EHD	B 185 APC	
AROCS 2040	01/2013 -	B 180 APC	B 180 EHD	B 185 APC	
AROCS 2040 A	01/2013 -	B 180 APC	B 180 EHD	B 185 APC	
AROCS 2040 AK	01/2013 -	B 180 APC	B 180 EHD	B 185 APC	
AROCS 2040 AS	01/2013 -	B 180 APC	B 180 EHD	B 185 APC	
AROCS 2040 K	01/2013 -	B 180 APC	B 180 EHD	B 185 APC	
AROCS 2040 S, 2040 LS	01/2013 -	B 180 APC	B 180 EHD	B 185 APC	
AROCS 2042	01/2013 -	B 180 APC	B 180 EHD	B 185 APC	
AROCS 2042 A	01/2013 -	B 180 APC	B 180 EHD	B 185 APC	
AROCS 2042 AK	01/2013 -	B 180 APC	B 180 EHD	B 185 APC	
AROCS 2042 AS	01/2013 -	B 180 APC	B 180 EHD	B 185 APC	
AROCS 2042 K	01/2013 -	B 180 APC	B 180 EHD	B 185 APC	
AROCS 2042 S, 2042 LS	01/2013 -	B 180 APC	B 180 EHD	B 185 APC	
AROCS 2043	01/2013 -	B 180 APC	B 180 EHD	B 185 APC	
AROCS 2043 A	01/2013 -	B 180 APC	B 180 EHD	B 185 APC	
AROCS 2043 AK	01/2013 -	B 180 APC	B 180 EHD	B 185 APC	
AROCS 2043 AS	01/2013 -	B 180 APC	B 180 EHD	B 185 APC	
AROCS 2043 K	01/2013 -	B 180 APC	B 180 EHD	B 185 APC	
AROCS 2043 S, 2043 LS	01/2013 -	B 180 APC	B 180 EHD	B 185 APC	
AROCS 2045	01/2013 -	B 180 APC	B 180 EHD	B 185 APC	
AROCS 2045 A	01/2013 -	B 180 APC	B 180 EHD	B 185 APC	
AROCS 2045 AK	01/2013 -	B 180 APC	B 180 EHD	B 185 APC	
AROCS 2045 AS	01/2013 -	B 180 APC	B 180 EHD	B 185 APC	
AROCS 2045 K	01/2013 -	B 180 APC	B 180 EHD	B 185 APC	
AROCS 2045 S, 2045 LS	01/2013 -	B 180 APC	B 180 EHD	B 185 APC	
AROCS 2048	01/2013 -	B 180 APC	B 180 EHD	B 185 APC	
AROCS 2048 A	01/2013 -	B 180 APC	B 180 EHD	B 185 APC	
AROCS 2048 AK	01/2013 -	B 180 APC	B 180 EHD	B 185 APC	
AROCS 2048 AS	01/2013 -	B 180 APC	B 180 EHD	B 185 APC	
AROCS 2048 K	01/2013 -	B 180 APC	B 180 EHD	B 185 APC	
AROCS 2048 S, 2048 LS	01/2013 -	B 180 APC	B 180 EHD	B 185 APC	
AROCS 2051	01/2013 -	B 180 APC	B 180 EHD	B 185 APC	
AROCS 2051 A	01/2013 -	B 180 APC	B 180 EHD	B 185 APC	
AROCS 2051 AK	01/2013 -	B 180 APC	B 180 EHD	B 185 APC	
AROCS 2051 AS	01/2013 -	B 180 APC	B 180 EHD	B 185 APC	
AROCS 2051 K	01/2013 -	B 180 APC	B 180 EHD	B 185 APC	
AROCS 2051 S, 2051 LS	01/2013 -	B 180 APC	B 180 EHD	B 185 APC	
AROCS 2527	01/2013 -	CX 225 APC		CX 220 APC	
AROCS 2527 LS	01/2013 -	B 180 APC	B 180 EHD	B 185 APC	
AROCS 2530 L	01/2013 -	B 180 APC	B 180 EHD	B 185 APC	
AROCS 2530 LS	01/2013 -	B 180 APC	B 180 EHD	B 185 APC	
AROCS 2532 L	01/2013 -	B 180 APC	B 180 EHD	B 185 APC	
AROCS 2532 LS	01/2013 -	B 180 APC	B 180 EHD	B 185 APC	

MARCHIO E MODELLO - MAKE AND MODEL MARQUE ET MODÈLE - MARKE UND MODELL MARCA Y MODELO - МАРКА И МОДЕЛЬ	Periodo Period	powerCUBE		energyCUBE	
		APC	EHD	APC	RST
MERCEDES-BENZ cont.					
AROCS 2533 L	01/2013 -	B 180 APC	B 180 EHD	B 185 APC	
AROCS 2533 LS	01/2013 -	B 180 APC	B 180 EHD	B 185 APC	
AROCS 2535 L	01/2013 -	B 180 APC	B 180 EHD	B 185 APC	
AROCS 2535 LS	01/2013 -	B 180 APC	B 180 EHD	B 185 APC	
AROCS 2536 L	01/2013 -	B 180 APC	B 180 EHD	B 185 APC	
AROCS 2536 LS	01/2013 -	B 180 APC	B 180 EHD	B 185 APC	
AROCS 2540 L	01/2013 -	B 180 APC	B 180 EHD	B 185 APC	
AROCS 2540 LS	01/2013 -	B 180 APC	B 180 EHD	B 185 APC	
AROCS 2542 L	01/2013 -	B 180 APC	B 180 EHD	B 185 APC	
AROCS 2542 LS	01/2013 -	B 180 APC	B 180 EHD	B 185 APC	
AROCS 2543 L	01/2013 -	B 180 APC	B 180 EHD	B 185 APC	
AROCS 2543 LS	01/2013 -	B 180 APC	B 180 EHD	B 185 APC	
AROCS 2545 L	01/2013 -	B 180 APC	B 180 EHD	B 185 APC	
AROCS 2545 LS	01/2013 -	B 180 APC	B 180 EHD	B 185 APC	
AROCS 2548 L	01/2013 -	B 180 APC	B 180 EHD	B 185 APC	
AROCS 2548 LS	01/2013 -	B 180 APC	B 180 EHD	B 185 APC	
AROCS 2551 L	01/2013 -	B 180 APC	B 180 EHD	B 185 APC	
AROCS 2551 LS	01/2013 -	B 180 APC	B 180 EHD	B 185 APC	
AROCS 2627 B, 2627 LB	01/2013 -	B 180 APC	B 180 EHD	B 185 APC	
AROCS 2627 K, 2627 LK	01/2013 -	B 180 APC	B 180 EHD	B 185 APC	
AROCS 2627 L	01/2013 -	CX 225 APC		CX 220 APC	
AROCS 2627 LS	01/2013 -	CX 225 APC		CX 220 APC	
AROCS 2627 S, 2627 LS	01/2013 -	B 180 APC	B 180 EHD	B 185 APC	
AROCS 2627, 2627 L	01/2013 -	B 180 APC	B 180 EHD	B 185 APC	
AROCS 2630 B, 2630 LB	01/2013 -	B 180 APC	B 180 EHD	B 185 APC	
AROCS 2630 K, 2630 LK	01/2013 -	B 180 APC	B 180 EHD	B 185 APC	
AROCS 2630 L	01/2013 -	CX 225 APC		CX 220 APC	
AROCS 2630 LS	01/2013 -	CX 225 APC		CX 220 APC	
AROCS 2630 S, 2630 LS	01/2013 -	B 180 APC	B 180 EHD	B 185 APC	
AROCS 2630, 2630 L	01/2013 -	B 180 APC	B 180 EHD	B 185 APC	
AROCS 2632 B, 2632 LB	01/2013 -	B 180 APC	B 180 EHD	B 185 APC	
AROCS 2632 K, 2632 LK	01/2013 -	B 180 APC	B 180 EHD	B 185 APC	
AROCS 2632 L	01/2013 -	CX 225 APC		CX 220 APC	
AROCS 2632 LS	01/2013 -	CX 225 APC		CX 220 APC	
AROCS 2632 S, 2632 LS	01/2013 -	B 180 APC	B 180 EHD	B 185 APC	
AROCS 2632, 2632 L	01/2013 -	B 180 APC	B 180 EHD	B 185 APC	
AROCS 2633 B, 2633 LB	01/2013 -	B 180 APC	B 180 EHD	B 185 APC	
AROCS 2633 K, 2633 LK	01/2013 -	B 180 APC	B 180 EHD	B 185 APC	
AROCS 2633 L	01/2013 -	CX 225 APC		CX 220 APC	
AROCS 2633 LS	01/2013 -	CX 225 APC		CX 220 APC	
AROCS 2633 S, 2633 LS	01/2013 -	B 180 APC	B 180 EHD	B 185 APC	
AROCS 2633, 2633 L	01/2013 -	B 180 APC	B 180 EHD	B 185 APC	
AROCS 2635 B, 2635 LB	01/2013 -	B 180 APC	B 180 EHD	B 185 APC	
AROCS 2635 K, 2635 LK	01/2013 -	B 180 APC	B 180 EHD	B 185 APC	
AROCS 2635 L	01/2013 -	CX 225 APC		CX 220 APC	

MARCHIO E MODELLO - MAKE AND MODEL MARQUE ET MODÈLE - MARKE UND MODELL MARCA Y MODELO - МАРКА И МОДЕЛЬ	Periodo Period	powerCUBE		energyCUBE	
		APC	EHD	APC	RST
MERCEDES-BENZ cont.					
AROCS 2635 LS	01/2013 -	CX 225 APC		CX 220 APC	
AROCS 2635 S, 2635 LS	01/2013 -	B 180 APC	B 180 EHD	B 185 APC	
AROCS 2635, 2635 L	01/2013 -	B 180 APC	B 180 EHD	B 185 APC	
AROCS 2636 B, 2636 LB	01/2013 -	B 180 APC	B 180 EHD	B 185 APC	
AROCS 2636 K, 2636 LK	01/2013 -	B 180 APC	B 180 EHD	B 185 APC	
AROCS 2636 L	01/2013 -	CX 225 APC		CX 220 APC	
AROCS 2636 LS	01/2013 -	CX 225 APC		CX 220 APC	
AROCS 2636 S, 2636 LS	01/2013 -	B 180 APC	B 180 EHD	B 185 APC	
AROCS 2636, 2636 L	01/2013 -	B 180 APC	B 180 EHD	B 185 APC	
AROCS 2640 B, 2640 LB	01/2013 -	B 180 APC	B 180 EHD	B 185 APC	
AROCS 2640 K, 2640 LK	01/2013 -	B 180 APC	B 180 EHD	B 185 APC	
AROCS 2640 L	01/2013 -	CX 225 APC		CX 220 APC	
AROCS 2640 LS	01/2013 -	CX 225 APC		CX 220 APC	
AROCS 2640 S, 2640 LS	01/2013 -	B 180 APC	B 180 EHD	B 185 APC	
AROCS 2640, 2640 L	01/2013 -	B 180 APC	B 180 EHD	B 185 APC	
AROCS 2642 B, 2642 LB	01/2013 -	B 180 APC	B 180 EHD	B 185 APC	
AROCS 2642 K, 2642 LK	01/2013 -	B 180 APC	B 180 EHD	B 185 APC	
AROCS 2642 L	01/2013 -	CX 225 APC		CX 220 APC	
AROCS 2642 LS	01/2013 -	CX 225 APC		CX 220 APC	
AROCS 2642 S, 2642 LS	01/2013 -	B 180 APC	B 180 EHD	B 185 APC	
AROCS 2642, 2642 L	01/2013 -	B 180 APC	B 180 EHD	B 185 APC	
AROCS 2643 B, 2643 LB	01/2013 -	B 180 APC	B 180 EHD	B 185 APC	
AROCS 2643 K, 2643 LK	01/2013 -	B 180 APC	B 180 EHD	B 185 APC	
AROCS 2643 L	01/2013 -	CX 225 APC		CX 220 APC	
AROCS 2643 LS	01/2013 -	CX 225 APC		CX 220 APC	
AROCS 2643 S, 2643 LS	01/2013 -	B 180 APC	B 180 EHD	B 185 APC	
AROCS 2643, 2643 L	01/2013 -	B 180 APC	B 180 EHD	B 185 APC	
AROCS 2645 B, 2645 LB	01/2013 -	B 180 APC	B 180 EHD	B 185 APC	
AROCS 2645 K, 2645 LK	01/2013 -	B 180 APC	B 180 EHD	B 185 APC	
AROCS 2645 L	01/2013 -	CX 225 APC		CX 220 APC	
AROCS 2645 LS	01/2013 -	CX 225 APC		CX 220 APC	
AROCS 2645 S, 2645 LS	01/2013 -	B 180 APC	B 180 EHD	B 185 APC	
AROCS 2645, 2645 L	01/2013 -	B 180 APC	B 180 EHD	B 185 APC	
AROCS 2648 B, 2648 LB	01/2013 -	B 180 APC	B 180 EHD	B 185 APC	
AROCS 2648 K, 2648 LK	01/2013 -	B 180 APC	B 180 EHD	B 185 APC	
AROCS 2648 L	01/2013 -	CX 225 APC		CX 220 APC	
AROCS 2648 LS	01/2013 -	CX 225 APC		CX 220 APC	
AROCS 2648 S, 2648 LS	01/2013 -	B 180 APC	B 180 EHD	B 185 APC	
AROCS 2648, 2648 L	01/2013 -	B 180 APC	B 180 EHD	B 185 APC	
AROCS 2651 B, 2651 LB	01/2013 -	B 180 APC	B 180 EHD	B 185 APC	
AROCS 2651 K, 2651 LK	01/2013 -	B 180 APC	B 180 EHD	B 185 APC	
AROCS 2651 L	01/2013 -	CX 225 APC		CX 220 APC	
AROCS 2651 LS	01/2013 -	CX 225 APC		CX 220 APC	
AROCS 2651 S, 2651 LS	01/2013 -	B 180 APC	B 180 EHD	B 185 APC	
AROCS 2651, 2651 L	01/2013 -	B 180 APC	B 180 EHD	B 185 APC	

MARCHIO E MODELLO - MAKE AND MODEL MARQUE ET MODÈLE - MARKE UND MODELL MARCA Y MODELO - МАРКА И МОДЕЛЬ	Periodo <i>Period</i>	powerCUBE		energyCUBE	
		APC	EHD	APC	RST
MERCEDES-BENZ <i>cont.</i>					
AROCS 3227 B, 3227 LB	01/2013 -	B 180 APC	B 180 EHD	B 185 APC	
AROCS 3227 K, 3227 LK	01/2013 -	B 180 APC	B 180 EHD	B 185 APC	
AROCS 3227 L	01/2013 -	B 180 APC	B 180 EHD	B 185 APC	
AROCS 3227 LB	01/2013 -	B 180 APC	B 180 EHD	B 185 APC	
AROCS 3227 LK	01/2013 -	B 180 APC	B 180 EHD	B 185 APC	
AROCS 3227, 3227 L	01/2013 -	B 180 APC	B 180 EHD	B 185 APC	
AROCS 3230 B, 3230 LB	01/2013 -	B 180 APC	B 180 EHD	B 185 APC	
AROCS 3230 K, 3230 LK	01/2013 -	B 180 APC	B 180 EHD	B 185 APC	
AROCS 3230 L	01/2013 -	B 180 APC	B 180 EHD	B 185 APC	
AROCS 3230 LB	01/2013 -	B 180 APC	B 180 EHD	B 185 APC	
AROCS 3230 LK	01/2013 -	B 180 APC	B 180 EHD	B 185 APC	
AROCS 3230, 3230 L	01/2013 -	B 180 APC	B 180 EHD	B 185 APC	
AROCS 3232 B, 3232 LB	01/2013 -	B 180 APC	B 180 EHD	B 185 APC	
AROCS 3232 K, 3232 LK	01/2013 -	B 180 APC	B 180 EHD	B 185 APC	
AROCS 3232 L	01/2013 -	B 180 APC	B 180 EHD	B 185 APC	
AROCS 3232 LB	01/2013 -	B 180 APC	B 180 EHD	B 185 APC	
AROCS 3232 LK	01/2013 -	B 180 APC	B 180 EHD	B 185 APC	
AROCS 3232, 3232 L	01/2013 -	B 180 APC	B 180 EHD	B 185 APC	
AROCS 3233 B, 3233 LB	01/2013 -	B 180 APC	B 180 EHD	B 185 APC	
AROCS 3233 K, 3233 LK	01/2013 -	B 180 APC	B 180 EHD	B 185 APC	
AROCS 3233 L	01/2013 -	B 180 APC	B 180 EHD	B 185 APC	
AROCS 3233 LB	01/2013 -	B 180 APC	B 180 EHD	B 185 APC	
AROCS 3233 LK	01/2013 -	B 180 APC	B 180 EHD	B 185 APC	
AROCS 3233, 3233 L	01/2013 -	B 180 APC	B 180 EHD	B 185 APC	
AROCS 3235 B, 3235 LB	01/2013 -	B 180 APC	B 180 EHD	B 185 APC	
AROCS 3235 K, 3235 LK	01/2013 -	B 180 APC	B 180 EHD	B 185 APC	
AROCS 3235 L	01/2013 -	B 180 APC	B 180 EHD	B 185 APC	
AROCS 3235 LB	01/2013 -	B 180 APC	B 180 EHD	B 185 APC	
AROCS 3235 LK	01/2013 -	B 180 APC	B 180 EHD	B 185 APC	
AROCS 3235, 3235 L	01/2013 -	B 180 APC	B 180 EHD	B 185 APC	
AROCS 3236 B, 3236 LB	01/2013 -	B 180 APC	B 180 EHD	B 185 APC	
AROCS 3236 K, 3236 LK	01/2013 -	B 180 APC	B 180 EHD	B 185 APC	
AROCS 3236 L	01/2013 -	B 180 APC	B 180 EHD	B 185 APC	
AROCS 3236 LB	01/2013 -	B 180 APC	B 180 EHD	B 185 APC	
AROCS 3236 LK	01/2013 -	B 180 APC	B 180 EHD	B 185 APC	
AROCS 3236, 3236 L	01/2013 -	B 180 APC	B 180 EHD	B 185 APC	
AROCS 3240 B, 3240 LB	01/2013 -	B 180 APC	B 180 EHD	B 185 APC	
AROCS 3240 K, 3240 LK	01/2013 -	B 180 APC	B 180 EHD	B 185 APC	
AROCS 3240 L	01/2013 -	B 180 APC	B 180 EHD	B 185 APC	
AROCS 3240 LB	01/2013 -	B 180 APC	B 180 EHD	B 185 APC	
AROCS 3240 LK	01/2013 -	B 180 APC	B 180 EHD	B 185 APC	
AROCS 3240, 3240 L	01/2013 -	B 180 APC	B 180 EHD	B 185 APC	
AROCS 3242 B, 3242 LB	01/2013 -	B 180 APC	B 180 EHD	B 185 APC	
AROCS 3242 K, 3242 LK	01/2013 -	B 180 APC	B 180 EHD	B 185 APC	
AROCS 3242 L	01/2013 -	B 180 APC	B 180 EHD	B 185 APC	

MARCHIO E MODELLO - MAKE AND MODEL MARQUE ET MODÈLE - MARKE UND MODELL MARCA Y MODELO - МАРКА И МОДЕЛЬ	Periodo Period	powerCUBE		energyCUBE	
		APC	EHD	APC	RST
MERCEDES-BENZ cont.					
AROCS 3242 LB	01/2013 -	B 180 APC	B 180 EHD	B 185 APC	
AROCS 3242 LK	01/2013 -	B 180 APC	B 180 EHD	B 185 APC	
AROCS 3242, 3242 L	01/2013 -	B 180 APC	B 180 EHD	B 185 APC	
AROCS 3243 B, 3243 LB	01/2013 -	B 180 APC	B 180 EHD	B 185 APC	
AROCS 3243 K, 3243 LK	01/2013 -	B 180 APC	B 180 EHD	B 185 APC	
AROCS 3243 L	01/2013 -	B 180 APC	B 180 EHD	B 185 APC	
AROCS 3243 LB	01/2013 -	B 180 APC	B 180 EHD	B 185 APC	
AROCS 3243 LK	01/2013 -	B 180 APC	B 180 EHD	B 185 APC	
AROCS 3243, 3243 L	01/2013 -	B 180 APC	B 180 EHD	B 185 APC	
AROCS 3245 B, 3245 LB	01/2013 -	B 180 APC	B 180 EHD	B 185 APC	
AROCS 3245 K, 3245 LK	01/2013 -	B 180 APC	B 180 EHD	B 185 APC	
AROCS 3245 L	01/2013 -	B 180 APC	B 180 EHD	B 185 APC	
AROCS 3245 LB	01/2013 -	B 180 APC	B 180 EHD	B 185 APC	
AROCS 3245 LK	01/2013 -	B 180 APC	B 180 EHD	B 185 APC	
AROCS 3245, 3245 L	01/2013 -	B 180 APC	B 180 EHD	B 185 APC	
AROCS 3248 B, 3248 LB	01/2013 -	B 180 APC	B 180 EHD	B 185 APC	
AROCS 3248 K, 3248 LK	01/2013 -	B 180 APC	B 180 EHD	B 185 APC	
AROCS 3248 L	01/2013 -	B 180 APC	B 180 EHD	B 185 APC	
AROCS 3248 LB	01/2013 -	B 180 APC	B 180 EHD	B 185 APC	
AROCS 3248 LK	01/2013 -	B 180 APC	B 180 EHD	B 185 APC	
AROCS 3248, 3248 L	01/2013 -	B 180 APC	B 180 EHD	B 185 APC	
AROCS 3251 B, 3251 LB	01/2013 -	B 180 APC	B 180 EHD	B 185 APC	
AROCS 3251 K, 3251 LK	01/2013 -	B 180 APC	B 180 EHD	B 185 APC	
AROCS 3251 L	01/2013 -	B 180 APC	B 180 EHD	B 185 APC	
AROCS 3251 LB	01/2013 -	B 180 APC	B 180 EHD	B 185 APC	
AROCS 3251 LK	01/2013 -	B 180 APC	B 180 EHD	B 185 APC	
AROCS 3251, 3251 L	01/2013 -	B 180 APC	B 180 EHD	B 185 APC	
AROCS 3333 A	01/2013 -	B 180 APC	B 180 EHD	B 185 APC	
AROCS 3333 AK	01/2013 -	B 180 APC	B 180 EHD	B 185 APC	
AROCS 3333 AS	01/2013 -	B 180 APC	B 180 EHD	B 185 APC	
AROCS 3333 B, 3333 LB	01/2013 -	B 180 APC	B 180 EHD	B 185 APC	
AROCS 3333 K, 3333 LK	01/2013 -	B 180 APC	B 180 EHD	B 185 APC	
AROCS 3333 S, 3333 LS	01/2013 -	B 180 APC	B 180 EHD	B 185 APC	
AROCS 3333, 3333 L	01/2013 -	B 180 APC	B 180 EHD	B 185 APC	
AROCS 3336 A	01/2013 -	B 180 APC	B 180 EHD	B 185 APC	
AROCS 3336 AK	01/2013 -	B 180 APC	B 180 EHD	B 185 APC	
AROCS 3336 AS	01/2013 -	B 180 APC	B 180 EHD	B 185 APC	
AROCS 3336 B, 3336 LB	01/2013 -	B 180 APC	B 180 EHD	B 185 APC	
AROCS 3336 K, 3336 LK	01/2013 -	B 180 APC	B 180 EHD	B 185 APC	
AROCS 3336 S, 3336 LS	01/2013 -	B 180 APC	B 180 EHD	B 185 APC	
AROCS 3336, 3336 L	01/2013 -	B 180 APC	B 180 EHD	B 185 APC	
AROCS 3340 A	01/2013 -	B 180 APC	B 180 EHD	B 185 APC	
AROCS 3340 AK	01/2013 -	B 180 APC	B 180 EHD	B 185 APC	
AROCS 3340 AS	01/2013 -	B 180 APC	B 180 EHD	B 185 APC	
AROCS 3340 B, 3340 LB	01/2013 -	B 180 APC	B 180 EHD	B 185 APC	

MARCHIO E MODELLO - MAKE AND MODEL MARQUE ET MODÈLE - MARKE UND MODELL MARCA Y MODELO - МАРКА И МОДЕЛЬ	Periodo Period	powerCUBE		energyCUBE	
		APC	EHD	APC	RST
MERCEDES-BENZ cont.					
AROCS 3340 K, 3340 LK	01/2013 -	B 180 APC	B 180 EHD	B 185 APC	
AROCS 3340 S, 3340 LS	01/2013 -	B 180 APC	B 180 EHD	B 185 APC	
AROCS 3340, 3340 L	01/2013 -	B 180 APC	B 180 EHD	B 185 APC	
AROCS 3342 A	01/2013 -	B 180 APC	B 180 EHD	B 185 APC	
AROCS 3342 AK	01/2013 -	B 180 APC	B 180 EHD	B 185 APC	
AROCS 3342 AS	01/2013 -	B 180 APC	B 180 EHD	B 185 APC	
AROCS 3342 B, 3342 LB	01/2013 -	B 180 APC	B 180 EHD	B 185 APC	
AROCS 3342 K, 3342 LK	01/2013 -	B 180 APC	B 180 EHD	B 185 APC	
AROCS 3342 S, 3342 LS	01/2013 -	B 180 APC	B 180 EHD	B 185 APC	
AROCS 3342, 3342 L	01/2013 -	B 180 APC	B 180 EHD	B 185 APC	
AROCS 3343 A	01/2013 -	B 180 APC	B 180 EHD	B 185 APC	
AROCS 3343 AK	01/2013 -	B 180 APC	B 180 EHD	B 185 APC	
AROCS 3343 AS	01/2013 -	B 180 APC	B 180 EHD	B 185 APC	
AROCS 3343 B, 3343 LB	01/2013 -	B 180 APC	B 180 EHD	B 185 APC	
AROCS 3343 K, 3343 LK	01/2013 -	B 180 APC	B 180 EHD	B 185 APC	
AROCS 3343 S, 3343 LS	01/2013 -	B 180 APC	B 180 EHD	B 185 APC	
AROCS 3343, 3343 L	01/2013 -	B 180 APC	B 180 EHD	B 185 APC	
AROCS 3345 A	01/2013 -	B 180 APC	B 180 EHD	B 185 APC	
AROCS 3345 AK	01/2013 -	B 180 APC	B 180 EHD	B 185 APC	
AROCS 3345 AS	01/2013 -	B 180 APC	B 180 EHD	B 185 APC	
AROCS 3345, 3345 L	01/2013 -	B 180 APC	B 180 EHD	B 185 APC	
AROCS 3345B, 3345 LB	01/2013 -	B 180 APC	B 180 EHD	B 185 APC	
AROCS 3345K, 3345 LK	01/2013 -	B 180 APC	B 180 EHD	B 185 APC	
AROCS 3345S, 3345 LS	01/2013 -	B 180 APC	B 180 EHD	B 185 APC	
AROCS 3348 A	01/2013 -	B 180 APC	B 180 EHD	B 185 APC	
AROCS 3348 AK	01/2013 -	B 180 APC	B 180 EHD	B 185 APC	
AROCS 3348 AS	01/2013 -	B 180 APC	B 180 EHD	B 185 APC	
AROCS 3348 B, 3348 LB	01/2013 -	B 180 APC	B 180 EHD	B 185 APC	
AROCS 3348 K, 3348 LK	01/2013 -	B 180 APC	B 180 EHD	B 185 APC	
AROCS 3348 S, 3348 LS	01/2013 -	B 180 APC	B 180 EHD	B 185 APC	
AROCS 3348, 3348 L	01/2013 -	B 180 APC	B 180 EHD	B 185 APC	
AROCS 3351 A	01/2013 -	B 180 APC	B 180 EHD	B 185 APC	
AROCS 3351 AK	01/2013 -	B 180 APC	B 180 EHD	B 185 APC	
AROCS 3351 AS	01/2013 -	B 180 APC	B 180 EHD	B 185 APC	
AROCS 3351 B, 3351 LB	01/2013 -	B 180 APC	B 180 EHD	B 185 APC	
AROCS 3351 K, 3351 LK	01/2013 -	B 180 APC	B 180 EHD	B 185 APC	
AROCS 3351 S, 3351 LS	01/2013 -	B 180 APC	B 180 EHD	B 185 APC	
AROCS 3351, 3351 L	01/2013 -	B 180 APC	B 180 EHD	B 185 APC	
AROCS 4133	01/2013 -	B 180 APC	B 180 EHD	B 185 APC	
AROCS 4133 AK	01/2013 -	B 180 APC	B 180 EHD	B 185 APC	
AROCS 4133 B	01/2013 -	B 180 APC	B 180 EHD	B 185 APC	
AROCS 4133 K	01/2013 -	B 180 APC	B 180 EHD	B 185 APC	
AROCS 4136	01/2013 -	B 180 APC	B 180 EHD	B 185 APC	
AROCS 4136 AK	01/2013 -	B 180 APC	B 180 EHD	B 185 APC	
AROCS 4136 B	01/2013 -	B 180 APC	B 180 EHD	B 185 APC	

MARCHIO E MODELLO - MAKE AND MODEL MARQUE ET MODÈLE - MARKE UND MODELL MARCA Y MODELO - МАРКА И МОДЕЛЬ	Periodo Period	powerCUBE		energyCUBE	
		APC	EHD	APC	RST
MERCEDES-BENZ cont.					
AROCS 4136 K	01/2013 -	B 180 APC	B 180 EHD	B 185 APC	
AROCS 4140	01/2013 -	B 180 APC	B 180 EHD	B 185 APC	
AROCS 4140 AK	01/2013 -	B 180 APC	B 180 EHD	B 185 APC	
AROCS 4140 B	01/2013 -	B 180 APC	B 180 EHD	B 185 APC	
AROCS 4140 K	01/2013 -	B 180 APC	B 180 EHD	B 185 APC	
AROCS 4142	01/2013 -	B 180 APC	B 180 EHD	B 185 APC	
AROCS 4142 AK	01/2013 -	B 180 APC	B 180 EHD	B 185 APC	
AROCS 4142 B	01/2013 -	B 180 APC	B 180 EHD	B 185 APC	
AROCS 4142 K	01/2013 -	B 180 APC	B 180 EHD	B 185 APC	
AROCS 4143	01/2013 -	B 180 APC	B 180 EHD	B 185 APC	
AROCS 4143 AK	01/2013 -	B 180 APC	B 180 EHD	B 185 APC	
AROCS 4143 B	01/2013 -	B 180 APC	B 180 EHD	B 185 APC	
AROCS 4143 K	01/2013 -	B 180 APC	B 180 EHD	B 185 APC	
AROCS 4145	01/2013 -	B 180 APC	B 180 EHD	B 185 APC	
AROCS 4145 AK	01/2013 -	B 180 APC	B 180 EHD	B 185 APC	
AROCS 4145 B	01/2013 -	B 180 APC	B 180 EHD	B 185 APC	
AROCS 4145 K	01/2013 -	B 180 APC	B 180 EHD	B 185 APC	
AROCS 4148	01/2013 -	B 180 APC	B 180 EHD	B 185 APC	
AROCS 4148 AK	01/2013 -	B 180 APC	B 180 EHD	B 185 APC	
AROCS 4148 B	01/2013 -	B 180 APC	B 180 EHD	B 185 APC	
AROCS 4148 K	01/2013 -	B 180 APC	B 180 EHD	B 185 APC	
AROCS 4151	01/2013 -	B 180 APC	B 180 EHD	B 185 APC	
AROCS 4151 AK	01/2013 -	B 180 APC	B 180 EHD	B 185 APC	
AROCS 4151 B	01/2013 -	B 180 APC	B 180 EHD	B 185 APC	
AROCS 4151 K	01/2013 -	B 180 APC	B 180 EHD	B 185 APC	
ATEGO 1014 K	01/1998 - 10/2004	A 135 APC	A 140 EHD		
ATEGO 1014, 1014 L	01/1998 - 10/2004	A 135 APC	A 140 EHD		
ATEGO 1017 A	01/1998 - 10/2004	A 135 APC	A 140 EHD / A 120 EHD		
ATEGO 1017 AK	01/1998 - 10/2004	A 135 APC	A 140 EHD / A 120 EHD		
ATEGO 1017 K	01/1998 - 10/2004	A 135 APC	A 140 EHD / A 120 EHD		
ATEGO 1017 KO	01/1998 - 10/2004	A 135 APC	A 140 EHD / A 120 EHD		
ATEGO 1017,1017 L	01/1998 - 10/2004	A 135 APC	A 140 EHD / A 120 EHD		
ATEGO 1023 AK	01/1998 - 10/2004	A 135 APC	A 140 EHD		
ATEGO 1023 K	01/1998 - 10/2004	A 135 APC	A 140 EHD		
ATEGO 1023,1023 L	01/1998 - 10/2004	A 135 APC	A 140 EHD / A 120 EHD		
ATEGO 1214 K	01/1998 - 10/2004	A 135 APC	A 140 EHD		
ATEGO 1214, 1214 L	01/1998 - 10/2004	A 135 APC	A 140 EHD / A 120 EHD		
ATEGO 1215 K	01/1998 - 10/2004	A 135 APC	A 140 EHD / A 120 EHD		
ATEGO 1215,1215 L	01/1998 - 10/2004	A 135 APC	A 140 EHD / A 120 EHD		
ATEGO 1217 K	01/1998 - 10/2004	A 135 APC	A 140 EHD / A 120 EHD		
ATEGO 1217 KO	01/1998 - 10/2004	A 135 APC	A 140 EHD / A 120 EHD		
ATEGO 1217,1217 L	01/1998 - 10/2004	A 135 APC	A 140 EHD / A 120 EHD		
ATEGO 1223 K	01/1998 - 09/2004	A 135 APC	A 140 EHD		
ATEGO 1223,1223 L	01/1998 - 10/2004	A 135 APC	A 140 EHD / A 120 EHD		
ATEGO 1225 AF	01/1998 - 10/2004	A 135 APC	A 140 EHD / A 120 EHD		

MARCHIO E MODELLO - MAKE AND MODEL MARQUE ET MODÈLE - MARKE UND MODELL MARCA Y MODELO - МАРКА И МОДЕЛЬ	Periodo Period	powerCUBE		energyCUBE	
		APC	EHD	APC	RST
MERCEDES-BENZ cont.					
ATEGO 1225 F	01/1998 - 10/2004	A 135 APC	A 140 EHD / A 120 EHD		
ATEGO 1228,1228 L	01/1998 - 10/2004	A 135 APC	A 140 EHD / A 120 EHD		
ATEGO 1317 A	01/1998 - 10/2004	A 135 APC	A 140 EHD / A 120 EHD		
ATEGO 1317 AK	01/1998 - 10/2004	A 135 APC	A 140 EHD / A 120 EHD		
ATEGO 1317 K	01/1998 - 10/2004	A 135 APC	A 140 EHD / A 120 EHD		
ATEGO 1317 K0	01/1998 - 10/2004	A 135 APC	A 140 EHD / A 120 EHD		
ATEGO 1317,1317 L	01/1998 - 10/2004	A 135 APC	A 140 EHD / A 120 EHD		
ATEGO 1323 AK	01/1998 - 09/2004	A 135 APC	A 140 EHD		
ATEGO 1323 K	01/1998 - 09/2004	A 135 APC	A 140 EHD		
ATEGO 1323 K0	01/1998 - 10/2004	A 135 APC	A 140 EHD / A 120 EHD		
ATEGO 1323 LS	01/1998 - 10/2004	A 135 APC	A 140 EHD / A 120 EHD		
ATEGO 1323,1323 L	01/1998 - 10/2004	A 135 APC	A 140 EHD / A 120 EHD		
ATEGO 1325 AF	01/1998 - 10/2004	A 135 APC	A 140 EHD / A 120 EHD		
ATEGO 1325 F	01/1998 - 10/2004	A 135 APC	A 140 EHD / A 120 EHD		
ATEGO 1328 AF	01/1998 - 10/2004	A 135 APC	A 140 EHD / A 120 EHD		
ATEGO 1328 F	01/1998 - 10/2004	A 135 APC	A 140 EHD / A 120 EHD		
ATEGO 1328 LS	01/1998 - 10/2004	A 135 APC	A 140 EHD / A 120 EHD		
ATEGO 1328,1328 L	01/1998 - 10/2004	A 135 APC	A 140 EHD / A 120 EHD		
ATEGO 1517 A	01/1998 - 10/2004	A 135 APC	A 140 EHD / A 120 EHD		
ATEGO 1517 AK	01/1998 - 10/2004	A 135 APC	A 140 EHD		
ATEGO 1517 K	01/1998 - 10/2004	A 135 APC	A 140 EHD / A 120 EHD		
ATEGO 1517,1517 L	01/1998 - 10/2004	A 135 APC	A 140 EHD / A 120 EHD		
ATEGO 1523 A	01/1998 - 10/2004	A 135 APC	A 140 EHD / A 120 EHD		
ATEGO 1523 AK	01/1998 - 10/2004	A 135 APC	A 140 EHD / A 120 EHD		
ATEGO 1523 K	01/1998 - 10/2004	A 135 APC	A 140 EHD / A 120 EHD		
ATEGO 1523 K0	01/1998 - 10/2004	A 135 APC	A 140 EHD / A 120 EHD		
ATEGO 1523,1523 L	01/1998 - 10/2004	A 135 APC	A 140 EHD / A 120 EHD		
ATEGO 1525 AF	01/1998 - 10/2004	A 135 APC	A 140 EHD / A 120 EHD		
ATEGO 1528 AF	01/1998 - 10/2004	A 135 APC	A 140 EHD / A 120 EHD		
ATEGO 1528 AK	01/1998 - 09/2004	A 135 APC	A 140 EHD		
ATEGO 1528 F	01/1998 - 10/2004	A 135 APC	A 140 EHD / A 120 EHD		
ATEGO 1528 K	01/1998 - 09/2004	A 135 APC	A 140 EHD		
ATEGO 1528,1528 L	01/1998 - 10/2004	A 135 APC	A 140 EHD / A 120 EHD		
ATEGO 1923 L	04/1998 - 09/2004	A 135 APC	A 140 EHD		
ATEGO 1928 L	04/1998 - 09/2004	A 135 APC	A 140 EHD		
ATEGO 2223 L	04/1998 - 09/2004	A 135 APC	A 140 EHD		
ATEGO 2228 L	04/1998 - 09/2004	A 135 APC	A 140 EHD		
ATEGO 712	01/1998 - 10/2004	A 135 APC	A 140 EHD / A 120 EHD		
ATEGO 714	01/1998 - 10/2004	A 135 APC	A 140 EHD / A 120 EHD		
ATEGO 714 K	01/1998 - 10/2004	A 135 APC	A 140 EHD / A 120 EHD		
ATEGO 715,715 L	01/1998 - 10/2004	A 135 APC	A 140 EHD / A 120 EHD		
ATEGO 717	01/1998 - 10/2004	A 135 APC	A 140 EHD / A 120 EHD		
ATEGO 717 K	01/1998 - 10/2004	A 135 APC	A 140 EHD / A 120 EHD		
ATEGO 812	01/1998 - 10/2004	A 135 APC	A 140 EHD / A 120 EHD		
ATEGO 814 K	01/1998 - 10/2004	A 135 APC	A 140 EHD / A 120 EHD		

MARCHIO E MODELLO - MAKE AND MODEL MARQUE ET MODÈLE - MARKE UND MODELL MARCA Y MODELO - МАРКА И МОДЕЛЬ	Periodo Period	powerCUBE		energyCUBE	
		APC	EHD	APC	RST
MERCEDES-BENZ cont.					
ATEGO 814, 814 L	01/1998 - 10/2004	A 135 APC	A 140 EHD / A 120 EHD		
ATEGO 815 F	01/1998 - 10/2004	A 135 APC	A 140 EHD / A 120 EHD		
ATEGO 815 K	01/1998 - 10/2004	A 135 APC	A 140 EHD / A 120 EHD		
ATEGO 815,815 L	01/1998 - 10/2004	A 135 APC	A 140 EHD / A 120 EHD		
ATEGO 817 K	01/1998 - 10/2004	A 135 APC	A 140 EHD / A 120 EHD		
ATEGO 817,817 L	01/1998 - 10/2004	A 135 APC	A 140 EHD / A 120 EHD		
ATEGO 823 K	01/1998 - 10/2004	A 135 APC	A 140 EHD / A 120 EHD		
ATEGO 823,823 L	01/1998 - 10/2004	A 135 APC	A 140 EHD / A 120 EHD		
ATEGO 914 K	01/1998 - 10/2004	A 135 APC	A 140 EHD		
ATEGO 914, 914 L	01/1998 - 10/2004	A 135 APC	A 140 EHD		
ATEGO 917 AF	01/1998 - 10/2004	A 135 APC	A 140 EHD / A 120 EHD		
ATEGO 917 K	01/1998 - 10/2004	A 135 APC	A 140 EHD / A 120 EHD		
ATEGO 917,917 L	01/1998 - 10/2004	A 135 APC	A 140 EHD / A 120 EHD		
ATEGO 923 K	01/1998 - 10/2004	A 135 APC	A 140 EHD / A 120 EHD		
ATEGO 923,923 L	01/1998 - 10/2004	A 135 APC	A 140 EHD / A 120 EHD		
ATEGO 925 AF	01/1998 - 10/2004	A 135 APC	A 140 EHD / A 120 EHD		
ATEGO 2 1015 K	10/2004 -	B 180 APC	B 180 EHD	B 185 APC	
ATEGO 2 1015, 1015 L	10/2004 -	B 180 APC	B 180 EHD	B 185 APC	
ATEGO 2 1016 K	10/2004 -	A 135 APC	A 140 EHD / A 120 EHD		
ATEGO 2 1016, 1016 L	10/2004 -	A 135 APC	A 140 EHD / A 120 EHD		
ATEGO 2 1017 AK	10/2004 -	B 180 APC	B 180 EHD	B 185 APC	
ATEGO 2 1018 A	10/2004 -	A 135 APC	A 140 EHD / A 120 EHD		
ATEGO 2 1018 AK	10/2004 -	B 180 APC	B 180 EHD	B 185 APC	
ATEGO 2 1018 K	10/2004 -	A 135 APC	A 140 EHD / A 120 EHD		
ATEGO 2 1018, 1018 L	10/2004 -	A 135 APC	A 140 EHD / A 120 EHD		
ATEGO 2 1022 A	10/2004 -	B 180 APC	B 180 EHD	B 185 APC	
ATEGO 2 1022 AK	10/2004 -	B 180 APC	B 180 EHD	B 185 APC	
ATEGO 2 1022 K	10/2004 -	A 135 APC	A 140 EHD / A 120 EHD		
ATEGO 2 1022 KO	10/2004 -	B 180 APC	B 180 EHD	B 185 APC	
ATEGO 2 1022, 1022 L	10/2004 -	A 135 APC	A 140 EHD / A 120 EHD		
ATEGO 2 1023 A, 1024 A	10/2004 -	A 135 APC	A 140 EHD / A 120 EHD		
ATEGO 2 1023, 1023 L, 1024, 1024 L	10/2004 -	A 135 APC	A 140 EHD / A 120 EHD		
ATEGO 2 1024 AK	10/2004 -	B 180 APC	B 180 EHD	B 185 APC	
ATEGO 2 1024 K	10/2004 -	A 135 APC	A 140 EHD / A 120 EHD		
ATEGO 2 1024, 1024 L	10/2004 -	B 180 APC	B 180 EHD	B 185 APC	
ATEGO 2 1026, 1026 L	10/2004 -	B 180 APC	B 180 EHD	B 185 APC	
ATEGO 2 1029, 1029 L	10/2004 -	B 180 APC	B 180 EHD	B 185 APC	
ATEGO 2 1118 AF	01/2011 -	B 180 APC	B 180 EHD	B 185 APC	
ATEGO 2 1215, 1215 L, 1216, 1216 L	10/2004 -	A 135 APC	A 140 EHD / A 120 EHD		
ATEGO 2 1216 K	10/2004 -	A 135 APC	A 140 EHD / A 120 EHD		
ATEGO 2 1216, 1216 L	10/2004 -	B 180 APC	B 180 EHD	B 185 APC	
ATEGO 2 1218 K	10/2004 -	A 135 APC	A 140 EHD / A 120 EHD		
ATEGO 2 1218, 1218 L	10/2004 -	A 135 APC	A 140 EHD / A 120 EHD		
ATEGO 2 1222 AF	10/2004 -	B 180 APC	B 180 EHD	B 185 APC	
ATEGO 2 1222 F	10/2004 -	B 180 APC	B 180 EHD	B 185 APC	

MARCHIO E MODELLO - MAKE AND MODEL MARQUE ET MODÈLE - MARKE UND MODELL MARCA Y MODELO - МАРКА И МОДЕЛЬ	Periodo Period	powerCUBE		energyCUBE	
		APC	EHD	APC	RST
MERCEDES-BENZ cont.					
ATEGO 2 1222 K	10/2004 -	A 135 APC	A 140 EHD / A 120 EHD		
ATEGO 2 1222, 1222 L	10/2004 -	A 135 APC	A 140 EHD / A 120 EHD		
ATEGO 2 1223, 1223 L, 1224, 1224 L	10/2004 -	A 135 APC	A 140 EHD / A 120 EHD		
ATEGO 2 1224 K	10/2004 -	A 135 APC	A 140 EHD / A 120 EHD		
ATEGO 2 1224, 1224 L	10/2004 -	B 180 APC	B 180 EHD	B 185 APC	
ATEGO 2 1226 AF	10/2004 -	B 180 APC	B 180 EHD	B 185 APC	
ATEGO 2 1226 F	10/2004 -	B 180 APC	B 180 EHD	B 185 APC	
ATEGO 2 1226, 1226 L	10/2004 -	A 135 APC	A 140 EHD / A 120 EHD		
ATEGO 2 1228, 1228 L, 1229, 1229 L	10/2004 -	A 135 APC	A 140 EHD / A 120 EHD		
ATEGO 2 1229, 1229 L	10/2004 -	B 180 APC	B 180 EHD	B 185 APC	
ATEGO 2 1315	01/2011 -	B 180 APC	B 180 EHD	B 185 APC	
ATEGO 2 1318 A	10/2004 -	A 135 APC	A 140 EHD / A 120 EHD		
ATEGO 2 1318 AK	10/2004 -	A 135 APC	A 140 EHD / A 120 EHD		
ATEGO 2 1318 K	10/2004 -	A 135 APC	A 140 EHD / A 120 EHD		
ATEGO 2 1318, 1318 L	10/2004 -	A 135 APC	A 140 EHD / A 120 EHD		
ATEGO 2 1322 A	10/2004 -	B 180 APC	B 180 EHD	B 185 APC	
ATEGO 2 1322 AF	10/2004 -	B 180 APC	B 180 EHD	B 185 APC	
ATEGO 2 1322 AK	10/2004 -	B 180 APC	B 180 EHD	B 185 APC	
ATEGO 2 1322 F	10/2004 -	B 180 APC	B 180 EHD	B 185 APC	
ATEGO 2 1322 K	10/2004 -	A 135 APC	A 140 EHD / A 120 EHD		
ATEGO 2 1322 LKO	10/2004 -	B 180 APC	B 180 EHD	B 185 APC	
ATEGO 2 1322 LS	10/2004 -	A 135 APC	A 140 EHD / A 120 EHD		
ATEGO 2 1322, 1322 L	10/2004 -	A 135 APC	A 140 EHD / A 120 EHD		
ATEGO 2 1323 A, 1324 A	10/2004 -	A 135 APC	A 140 EHD / A 120 EHD		
ATEGO 2 1323 LS, 1324 LS	10/2004 -	A 135 APC	A 140 EHD / A 120 EHD		
ATEGO 2 1323, 1323 L, 1324, 1324 L	10/2004 -	A 135 APC	A 140 EHD / A 120 EHD		
ATEGO 2 1324 AK	10/2004 -	A 135 APC	A 140 EHD / A 120 EHD		
ATEGO 2 1324 K	10/2004 -	A 135 APC	A 140 EHD / A 120 EHD		
ATEGO 2 1324 LKO	10/2004 -	B 180 APC	B 180 EHD	B 185 APC	
ATEGO 2 1324, 1324 L	10/2004 -	B 180 APC	B 180 EHD	B 185 APC	
ATEGO 2 1326 AF	10/2004 -	B 180 APC	B 180 EHD	B 185 APC	
ATEGO 2 1326 F	10/2004 -	B 180 APC	B 180 EHD	B 185 APC	
ATEGO 2 1326 LS	10/2004 -	A 135 APC	A 140 EHD / A 120 EHD		
ATEGO 2 1326, 1326 L	10/2004 -	A 135 APC	A 140 EHD / A 120 EHD		
ATEGO 2 1328 LS, 1329 LS	10/2004 -	A 135 APC	A 140 EHD / A 120 EHD		
ATEGO 2 1328, 1328 L, 1329, 1329 L	10/2004 -	A 135 APC	A 140 EHD / A 120 EHD		
ATEGO 2 1329 AF	10/2004 -	B 180 APC	B 180 EHD	B 185 APC	
ATEGO 2 1329 F	10/2004 -	B 180 APC	B 180 EHD	B 185 APC	
ATEGO 2 1329, 1329 L	10/2004 -	B 180 APC	B 180 EHD	B 185 APC	
ATEGO 2 1418	01/2011 -	B 180 APC	B 180 EHD	B 185 APC	
ATEGO 2 1418 K	01/2011 -	B 180 APC	B 180 EHD	B 185 APC	
ATEGO 2 1419	10/2004 -	B 180 APC	B 180 EHD	B 185 APC	
ATEGO 2 1518 A	10/2004 -	A 135 APC	A 140 EHD / A 120 EHD		
ATEGO 2 1518 AK	10/2004 -	B 180 APC	B 180 EHD	B 185 APC	
ATEGO 2 1518 K	10/2004 -	A 135 APC	A 140 EHD / A 120 EHD		

MARCHIO E MODELLO - MAKE AND MODEL MARQUE ET MODÈLE - MARKE UND MODELL MARCA Y MODELO - МАРКА И МОДЕЛЬ	Periodo Period	powerCUBE		energyCUBE	
		APC	EHD	APC	RST
MERCEDES-BENZ cont.					
ATEGO 2 1518, 1518 L	10/2004 -	A 135 APC	A 140 EHD / A 120 EHD		
ATEGO 2 1522 A	10/2004 -	B 180 APC	B 180 EHD	B 185 APC	
ATEGO 2 1522 AF	10/2004 -	B 180 APC	B 180 EHD	B 185 APC	
ATEGO 2 1522 AK	10/2004 -	B 180 APC	B 180 EHD	B 185 APC	
ATEGO 2 1522 F	10/2004 -	B 180 APC	B 180 EHD	B 185 APC	
ATEGO 2 1522 K	10/2004 -	A 135 APC	A 140 EHD / A 120 EHD		
ATEGO 2 1522, 1522 L	10/2004 -	A 135 APC	A 140 EHD / A 120 EHD		
ATEGO 2 1523 A, 1524 A	10/2004 -	A 135 APC	A 140 EHD / A 120 EHD		
ATEGO 2 1523, 1523 L, 1524, 1524 L	10/2004 -	A 135 APC	A 140 EHD / A 120 EHD		
ATEGO 2 1524 AK	10/2004 -	A 135 APC	A 140 EHD / A 120 EHD		
ATEGO 2 1524 K	10/2004 -	A 135 APC	A 140 EHD / A 120 EHD		
ATEGO 2 1524, 1524 L	10/2004 -	B 180 APC	B 180 EHD	B 185 APC	
ATEGO 2 1526 AF	10/2004 -	B 180 APC	B 180 EHD	B 185 APC	
ATEGO 2 1526 AK	10/2004 -	A 135 APC	A 140 EHD / A 120 EHD		
ATEGO 2 1526 K	10/2004 -	A 135 APC	A 140 EHD / A 120 EHD		
ATEGO 2 1526, 1526 L	10/2004 -	A 135 APC	A 140 EHD / A 120 EHD		
ATEGO 2 1528, 1528 L, 1529, 1529 L	10/2004 -	A 135 APC	A 140 EHD / A 120 EHD		
ATEGO 2 1529 AF	10/2004 -	B 180 APC	B 180 EHD	B 185 APC	
ATEGO 2 1529 AK	10/2004 -	A 135 APC	A 140 EHD / A 120 EHD		
ATEGO 2 1529 F	10/2004 -	B 180 APC	B 180 EHD	B 185 APC	
ATEGO 2 1529 K	10/2004 -	A 135 APC	A 140 EHD / A 120 EHD		
ATEGO 2 1529, 1529 L	10/2004 -	B 180 APC	B 180 EHD	B 185 APC	
ATEGO 2 1618		A 135 APC	A 140 EHD / A 120 EHD		
ATEGO 2 1618 K		A 135 APC	A 140 EHD / A 120 EHD		
ATEGO 2 1622		A 135 APC	A 140 EHD / A 120 EHD		
ATEGO 2 1622 K		A 135 APC	A 140 EHD / A 120 EHD		
ATEGO 2 1624		A 135 APC	A 140 EHD / A 120 EHD		
ATEGO 2 1624 K		A 135 APC	A 140 EHD / A 120 EHD		
ATEGO 2 1629		A 135 APC	A 140 EHD / A 120 EHD		
ATEGO 2 1718	01/2011 -	B 180 APC	B 180 EHD	B 185 APC	
ATEGO 2 1718 K	01/2011 -	B 180 APC	B 180 EHD	B 185 APC	
ATEGO 2 1719	10/2004 -	B 180 APC	B 180 EHD	B 185 APC	
ATEGO 2 1722	10/2004 -	B 180 APC	B 180 EHD	B 185 APC	
ATEGO 2 1725	01/2011 -	B 180 APC	B 180 EHD	B 185 APC	
ATEGO 2 1725 A	01/2011 -	B 180 APC	B 180 EHD	B 185 APC	
ATEGO 2 1725 K	01/2011 -	B 180 APC	B 180 EHD	B 185 APC	
ATEGO 2 1725 S	01/2007 -	B 180 APC	B 180 EHD	B 185 APC	
ATEGO 2 1728	01/2011 -	B 180 APC	B 180 EHD	B 185 APC	
ATEGO 2 1728 S	01/2007 -	B 180 APC	B 180 EHD	B 185 APC	
ATEGO 2 1924 L	10/2004 -	B 180 APC	B 180 EHD	B 185 APC	
ATEGO 2 1926 L	10/2004 -	B 180 APC	B 180 EHD	B 185 APC	
ATEGO 2 1929 L	10/2004 -	B 180 APC	B 180 EHD	B 185 APC	
ATEGO 2 2224 L	10/2004 -	B 180 APC	B 180 EHD	B 185 APC	
ATEGO 2 2226 L	10/2004 -	B 180 APC	B 180 EHD	B 185 APC	
ATEGO 2 2229 L	10/2004 -	B 180 APC	B 180 EHD	B 185 APC	

MARCHIO E MODELLO - MAKE AND MODEL MARQUE ET MODÈLE - MARKE UND MODELL MARCA Y MODELO - МАРКА И МОДЕЛЬ	Periodo Period	powerCUBE		energyCUBE	
		APC	EHD	APC	RST
MERCEDES-BENZ cont.					
ATEGO 2 2422	10/2004 -	B 180 APC	B 180 EHD	B 185 APC	
ATEGO 2 2425	01/2011 -	B 180 APC	B 180 EHD	B 185 APC	
ATEGO 2 2428	01/2011 -	B 180 APC	B 180 EHD	B 185 APC	
ATEGO 2 2428	10/2004 -	B 180 APC	B 180 EHD	B 185 APC	
ATEGO 2 2529 L	10/2004 -	B 180 APC	B 180 EHD	B 185 APC	
ATEGO 2 712, 713	10/2004 -	A 135 APC	A 140 EHD / A 120 EHD		
ATEGO 2 715, 715 L, 716, 716 L	10/2004 -	A 135 APC	A 140 EHD / A 120 EHD		
ATEGO 2 812 K	10/2004 -	A 135 APC	A 140 EHD / A 120 EHD		
ATEGO 2 812, 813	10/2004 -	A 135 APC	A 140 EHD / A 120 EHD		
ATEGO 2 815 F	10/2004 -	B 180 APC	B 180 EHD	B 185 APC	
ATEGO 2 815 K, 816 K	10/2004 -	A 135 APC	A 140 EHD / A 120 EHD		
ATEGO 2 815, 815 L, 816, 816 L	10/2004 -	A 135 APC	A 140 EHD / A 120 EHD		
ATEGO 2 816, 816 L	10/2004 -	A 135 APC	A 140 EHD / A 120 EHD		
ATEGO 2 818 K	10/2004 -	A 135 APC	A 140 EHD / A 120 EHD		
ATEGO 2 818, 818 L	10/2004 -	A 135 APC	A 140 EHD / A 120 EHD		
ATEGO 2 822 F	10/2004 -	B 180 APC	B 180 EHD	B 185 APC	
ATEGO 2 822 K	10/2004 -	A 135 APC	A 140 EHD / A 120 EHD		
ATEGO 2 822, 822 L	10/2004 -	A 135 APC	A 140 EHD / A 120 EHD		
ATEGO 2 823, 823 L, 824, 824 L	01/1998 -	A 135 APC	A 140 EHD / A 120 EHD		
ATEGO 2 824 K	01/1998 -	A 135 APC	A 140 EHD / A 120 EHD		
ATEGO 2 824, 824 L	10/2004 -	B 180 APC	B 180 EHD	B 185 APC	
ATEGO 2 826, 826 L	10/2004 -	B 180 APC	B 180 EHD	B 185 APC	
ATEGO 2 829, 829 L	10/2004 -	B 180 APC	B 180 EHD	B 185 APC	
ATEGO 2 915 K	10/2004 -	B 180 APC	B 180 EHD	B 185 APC	
ATEGO 2 915, 915 L, 916, 916 L	10/2004 -	A 135 APC	A 140 EHD / A 120 EHD		
ATEGO 2 916 K	10/2004 -	A 135 APC	A 140 EHD / A 120 EHD		
ATEGO 2 916, 916 L	10/2004 -	B 180 APC	B 180 EHD	B 185 APC	
ATEGO 2 918 AF	10/2004 -	B 180 APC	B 180 EHD	B 185 APC	
ATEGO 2 918 K	10/2004 -	A 135 APC	A 140 EHD / A 120 EHD		
ATEGO 2 918, 918 L	10/2004 -	A 135 APC	A 140 EHD / A 120 EHD		
ATEGO 2 922 AF	10/2004 -	B 180 APC	B 180 EHD	B 185 APC	
ATEGO 2 922 K	10/2004 -	A 135 APC	A 140 EHD / A 120 EHD		
ATEGO 2 922, 922 L	10/2004 -	A 135 APC	A 140 EHD / A 120 EHD		
ATEGO 2 923, 923 L, 924, 924 L	10/2004 -	A 135 APC	A 140 EHD / A 120 EHD		
ATEGO 2 924 K	10/2004 -	A 135 APC	A 140 EHD / A 120 EHD		
ATEGO 2 924, 924 L	10/2004 -	B 180 APC	B 180 EHD	B 185 APC	
ATEGO 2 926 AF	10/2004 -	B 180 APC	B 180 EHD	B 185 APC	
ATEGO 2 926, 926 L	10/2004 -	B 180 APC	B 180 EHD	B 185 APC	
ATEGO 2 929, 929 L	10/2004 -	B 180 APC	B 180 EHD	B 185 APC	
Atego 3 (BM967) 1016 K	01/2010 -	B 180 APC	B 180 EHD	B 185 APC	
Atego 3 (BM967) 1016, 1016 L	01/2010 -	B 180 APC	B 180 EHD	B 185 APC	
Atego 3 (BM967) 1018 A	01/2010 -	B 180 APC	B 180 EHD	B 185 APC	
Atego 3 (BM967) 1018 AK	01/2010 -	B 180 APC	B 180 EHD	B 185 APC	
Atego 3 (BM967) 1018 K	01/2010 -	B 180 APC	B 180 EHD	B 185 APC	
Atego 3 (BM967) 1018 KO	01/2010 -	B 180 APC	B 180 EHD	B 185 APC	

MARCHIO E MODELLO - MAKE AND MODEL MARQUE ET MODÈLE - MARKE UND MODELL MARCA Y MODELO - МАРКА И МОДЕЛЬ	Periodo Period	powerCUBE		energyCUBE	
		APC	EHD	APC	RST
MERCEDES-BENZ cont.					
Atego 3 (BM967) 1018, 1018 L	01/2010 -	B 180 APC	B 180 EHD	B 185 APC	
Atego 3 (BM967) 1021 A	01/2010 -	B 180 APC	B 180 EHD	B 185 APC	
Atego 3 (BM967) 1021 AK	01/2010 -	B 180 APC	B 180 EHD	B 185 APC	
Atego 3 (BM967) 1021 K	01/2010 -	B 180 APC	B 180 EHD	B 185 APC	
Atego 3 (BM967) 1021 KO	01/2010 -	B 180 APC	B 180 EHD	B 185 APC	
Atego 3 (BM967) 1021, 1021 L	01/2010 -	B 180 APC	B 180 EHD	B 185 APC	
Atego 3 (BM967) 1023 A	01/2010 -	B 180 APC	B 180 EHD	B 185 APC	
Atego 3 (BM967) 1023 AK	01/2010 -	B 180 APC	B 180 EHD	B 185 APC	
Atego 3 (BM967) 1023 K	01/2010 -	B 180 APC	B 180 EHD	B 185 APC	
Atego 3 (BM967) 1023 KO	01/2010 -	B 180 APC	B 180 EHD	B 185 APC	
Atego 3 (BM967) 1023, 1023 L	01/2010 -	B 180 APC	B 180 EHD	B 185 APC	
Atego 3 (BM967) 1024 A	01/2010 -	B 180 APC	B 180 EHD	B 185 APC	
Atego 3 (BM967) 1024 AK	01/2010 -	B 180 APC	B 180 EHD	B 185 APC	
Atego 3 (BM967) 1024 K	01/2010 -	B 180 APC	B 180 EHD	B 185 APC	
Atego 3 (BM967) 1024, 1024 L	01/2010 -	B 180 APC	B 180 EHD	B 185 APC	
Atego 3 (BM967) 1216 K	01/2010 -	B 180 APC	B 180 EHD	B 185 APC	
Atego 3 (BM967) 1216, 1216 L	01/2010 -	B 180 APC	B 180 EHD	B 185 APC	
Atego 3 (BM967) 1218 K	01/2010 -	B 180 APC	B 180 EHD	B 185 APC	
Atego 3 (BM967) 1218, 1218 L	01/2010 -	B 180 APC	B 180 EHD	B 185 APC	
Atego 3 (BM967) 1221 K	01/2010 -	B 180 APC	B 180 EHD	B 185 APC	
Atego 3 (BM967) 1221, 1221 L	01/2010 -	B 180 APC	B 180 EHD	B 185 APC	
Atego 3 (BM967) 1223 AF	01/2010 -	B 180 APC	B 180 EHD	B 185 APC	
Atego 3 (BM967) 1223 F	01/2010 -	B 180 APC	B 180 EHD	B 185 APC	
Atego 3 (BM967) 1223 K	01/2010 -	B 180 APC	B 180 EHD	B 185 APC	
Atego 3 (BM967) 1223, 1223 L	01/2010 -	B 180 APC	B 180 EHD	B 185 APC	
Atego 3 (BM967) 1224 K	01/2010 -	B 180 APC	B 180 EHD	B 185 APC	
Atego 3 (BM967) 1224, 1224 L	01/2010 -	B 180 APC	B 180 EHD	B 185 APC	
Atego 3 (BM967) 1227 AF	01/2010 -	B 180 APC	B 180 EHD	B 185 APC	
Atego 3 (BM967) 1227 F	01/2010 -	B 180 APC	B 180 EHD	B 185 APC	
Atego 3 (BM967) 1227 K	01/2010 -	B 180 APC	B 180 EHD	B 185 APC	
Atego 3 (BM967) 1227, 1227 L	01/2010 -	B 180 APC	B 180 EHD	B 185 APC	
Atego 3 (BM967) 1230 AF	01/2010 -	B 180 APC	B 180 EHD	B 185 APC	
Atego 3 (BM967) 1230 F	01/2010 -	B 180 APC	B 180 EHD	B 185 APC	
Atego 3 (BM967) 1230 K	01/2010 -	B 180 APC	B 180 EHD	B 185 APC	
Atego 3 (BM967) 1230, 1230 L	01/2010 -	B 180 APC	B 180 EHD	B 185 APC	
Atego 3 (BM967) 1318 A	01/2010 -	B 180 APC	B 180 EHD	B 185 APC	
Atego 3 (BM967) 1318 AK	01/2010 -	B 180 APC	B 180 EHD	B 185 APC	
Atego 3 (BM967) 1318 K	01/2010 -	B 180 APC	B 180 EHD	B 185 APC	
Atego 3 (BM967) 1318 LKO	01/2010 -	B 180 APC	B 180 EHD	B 185 APC	
Atego 3 (BM967) 1318, 1318 L	01/2010 -	B 180 APC	B 180 EHD	B 185 APC	
Atego 3 (BM967) 1321 A	01/2010 -	B 180 APC	B 180 EHD	B 185 APC	
Atego 3 (BM967) 1321 AK	01/2010 -	B 180 APC	B 180 EHD	B 185 APC	
Atego 3 (BM967) 1321 K	01/2010 -	B 180 APC	B 180 EHD	B 185 APC	
Atego 3 (BM967) 1321 LKO	01/2010 -	B 180 APC	B 180 EHD	B 185 APC	
Atego 3 (BM967) 1321 LS	01/2010 -	B 180 APC	B 180 EHD	B 185 APC	

MARCHIO E MODELLO - MAKE AND MODEL MARQUE ET MODÈLE - MARKE UND MODELL MARCA Y MODELO - МАРКА И МОДЕЛЬ	Periodo Period	powerCUBE		energyCUBE	
		APC	EHD	APC	RST
MERCEDES-BENZ cont.					
Atego 3 (BM967) 1321, 1321 L	01/2010 -	B 180 APC	B 180 EHD	B 185 APC	
Atego 3 (BM967) 1323 A	01/2010 -	B 180 APC	B 180 EHD	B 185 APC	
Atego 3 (BM967) 1323 AF	01/2010 -	B 180 APC	B 180 EHD	B 185 APC	
Atego 3 (BM967) 1323 AK	01/2010 -	B 180 APC	B 180 EHD	B 185 APC	
Atego 3 (BM967) 1323 F	01/2010 -	B 180 APC	B 180 EHD	B 185 APC	
Atego 3 (BM967) 1323 K	01/2010 -	B 180 APC	B 180 EHD	B 185 APC	
Atego 3 (BM967) 1323 LKO	01/2010 -	B 180 APC	B 180 EHD	B 185 APC	
Atego 3 (BM967) 1323 LS	01/2010 -	B 180 APC	B 180 EHD	B 185 APC	
Atego 3 (BM967) 1323, 1323 L	01/2010 -	B 180 APC	B 180 EHD	B 185 APC	
Atego 3 (BM967) 1324 A	01/2010 -	B 180 APC	B 180 EHD	B 185 APC	
Atego 3 (BM967) 1324 AK	01/2010 -	B 180 APC	B 180 EHD	B 185 APC	
Atego 3 (BM967) 1324 K	01/2010 -	B 180 APC	B 180 EHD	B 185 APC	
Atego 3 (BM967) 1324 LKO	01/2010 -	B 180 APC	B 180 EHD	B 185 APC	
Atego 3 (BM967) 1324 LS	01/2010 -	B 180 APC	B 180 EHD	B 185 APC	
Atego 3 (BM967) 1324, 1324 L	01/2010 -	B 180 APC	B 180 EHD	B 185 APC	
Atego 3 (BM967) 1327 AF	01/2010 -	B 180 APC	B 180 EHD	B 185 APC	
Atego 3 (BM967) 1327 AK	01/2010 -	B 180 APC	B 180 EHD	B 185 APC	
Atego 3 (BM967) 1327 F	01/2010 -	B 180 APC	B 180 EHD	B 185 APC	
Atego 3 (BM967) 1327 K	01/2010 -	B 180 APC	B 180 EHD	B 185 APC	
Atego 3 (BM967) 1327 LS	01/2010 -	B 180 APC	B 180 EHD	B 185 APC	
Atego 3 (BM967) 1327, 1327 L	01/2010 -	B 180 APC	B 180 EHD	B 185 APC	
Atego 3 (BM967) 1330 AF	01/2010 -	B 180 APC	B 180 EHD	B 185 APC	
Atego 3 (BM967) 1330 AK	01/2010 -	B 180 APC	B 180 EHD	B 185 APC	
Atego 3 (BM967) 1330 F	01/2010 -	B 180 APC	B 180 EHD	B 185 APC	
Atego 3 (BM967) 1330 K	01/2010 -	B 180 APC	B 180 EHD	B 185 APC	
Atego 3 (BM967) 1330 LS	01/2010 -	B 180 APC	B 180 EHD	B 185 APC	
Atego 3 (BM967) 1330, 1330 L	01/2010 -	B 180 APC	B 180 EHD	B 185 APC	
Atego 3 (BM967) 1518 A	01/2010 -	B 180 APC	B 180 EHD	B 185 APC	
Atego 3 (BM967) 1518 K	01/2010 -	B 180 APC	B 180 EHD	B 185 APC	
Atego 3 (BM967) 1518, 1518 L	01/2010 -	B 180 APC	B 180 EHD	B 185 APC	
Atego 3 (BM967) 1521 A	01/2010 -	B 180 APC	B 180 EHD	B 185 APC	
Atego 3 (BM967) 1521 AK	01/2010 -	B 180 APC	B 180 EHD	B 185 APC	
Atego 3 (BM967) 1521 K	01/2010 -	B 180 APC	B 180 EHD	B 185 APC	
Atego 3 (BM967) 1521, 1521 L	01/2010 -	B 180 APC	B 180 EHD	B 185 APC	
Atego 3 (BM967) 1523 A	01/2010 -	B 180 APC	B 180 EHD	B 185 APC	
Atego 3 (BM967) 1523 AK	01/2010 -	B 180 APC	B 180 EHD	B 185 APC	
Atego 3 (BM967) 1523 K	01/2010 -	B 180 APC	B 180 EHD	B 185 APC	
Atego 3 (BM967) 1523, 1523 L	01/2010 -	B 180 APC	B 180 EHD	B 185 APC	
Atego 3 (BM967) 1524 A	01/2010 -	B 180 APC	B 180 EHD	B 185 APC	
Atego 3 (BM967) 1524 AK	01/2010 -	B 180 APC	B 180 EHD	B 185 APC	
Atego 3 (BM967) 1524 K	01/2010 -	B 180 APC	B 180 EHD	B 185 APC	
Atego 3 (BM967) 1524, 1524 L	01/2010 -	B 180 APC	B 180 EHD	B 185 APC	
Atego 3 (BM967) 1527 AF	01/2010 -	B 180 APC	B 180 EHD	B 185 APC	
Atego 3 (BM967) 1527 AK	01/2010 -	B 180 APC	B 180 EHD	B 185 APC	
Atego 3 (BM967) 1527 F	01/2010 -	B 180 APC	B 180 EHD	B 185 APC	

MARCHIO E MODELLO - MAKE AND MODEL MARQUE ET MODÈLE - MARKE UND MODELL MARCA Y MODELO - МАРКА И МОДЕЛЬ	Periodo Period	powerCUBE		energyCUBE	
		APC	EHD	APC	RST
MERCEDES-BENZ cont.					
Atego 3 (BM967) 1527 K	01/2010 -	B 180 APC	B 180 EHD	B 185 APC	
Atego 3 (BM967) 1527, 1527 L	01/2010 -	B 180 APC	B 180 EHD	B 185 APC	
Atego 3 (BM967) 1530 AF	01/2010 -	B 180 APC	B 180 EHD	B 185 APC	
Atego 3 (BM967) 1530 AK	01/2010 -	B 180 APC	B 180 EHD	B 185 APC	
Atego 3 (BM967) 1530 F	01/2010 -	B 180 APC	B 180 EHD	B 185 APC	
Atego 3 (BM967) 1530 K	01/2010 -	B 180 APC	B 180 EHD	B 185 APC	
Atego 3 (BM967) 1530, 1530 L	01/2010 -	B 180 APC	B 180 EHD	B 185 APC	
Atego 3 (BM967) 716 K	01/2010 -	B 180 APC	B 180 EHD	B 185 APC	
Atego 3 (BM967) 716, 716 L	01/2010 -	B 180 APC	B 180 EHD	B 185 APC	
Atego 3 (BM967) 718 K	01/2010 -	B 180 APC	B 180 EHD	B 185 APC	
Atego 3 (BM967) 718, 718 L	01/2010 -	B 180 APC	B 180 EHD	B 185 APC	
Atego 3 (BM967) 721 K	01/2010 -	B 180 APC	B 180 EHD	B 185 APC	
Atego 3 (BM967) 721, 721 L	01/2010 -	B 180 APC	B 180 EHD	B 185 APC	
Atego 3 (BM967) 723 K	01/2010 -	B 180 APC	B 180 EHD	B 185 APC	
Atego 3 (BM967) 723, 723 L	01/2010 -	B 180 APC	B 180 EHD	B 185 APC	
Atego 3 (BM967) 816 K	01/2010 -	B 180 APC	B 180 EHD	B 185 APC	
Atego 3 (BM967) 816, 816 L	01/2010 -	B 180 APC	B 180 EHD	B 185 APC	
Atego 3 (BM967) 818 K	01/2010 -	B 180 APC	B 180 EHD	B 185 APC	
Atego 3 (BM967) 818, 818 L	01/2010 -	B 180 APC	B 180 EHD	B 185 APC	
Atego 3 (BM967) 821 K	01/2010 -	B 180 APC	B 180 EHD	B 185 APC	
Atego 3 (BM967) 821, 821 L	01/2010 -	B 180 APC	B 180 EHD	B 185 APC	
Atego 3 (BM967) 823 K	01/2010 -	B 180 APC	B 180 EHD	B 185 APC	
Atego 3 (BM967) 823, 823 L	01/2010 -	B 180 APC	B 180 EHD	B 185 APC	
Atego 3 (BM967) 824 K	01/2010 -	B 180 APC	B 180 EHD	B 185 APC	
Atego 3 (BM967) 824, 824 L	01/2010 -	B 180 APC	B 180 EHD	B 185 APC	
Atego 3 (BM967) 916 K	01/2010 -	B 180 APC	B 180 EHD	B 185 APC	
Atego 3 (BM967) 916, 916 L	01/2010 -	B 180 APC	B 180 EHD	B 185 APC	
Atego 3 (BM967) 918 AF	01/2010 -	B 180 APC	B 180 EHD	B 185 APC	
Atego 3 (BM967) 918 F	01/2010 -	B 180 APC	B 180 EHD	B 185 APC	
Atego 3 (BM967) 918 K	01/2010 -	B 180 APC	B 180 EHD	B 185 APC	
Atego 3 (BM967) 918, 918 L	01/2010 -	B 180 APC	B 180 EHD	B 185 APC	
Atego 3 (BM967) 921 K	01/2010 -	B 180 APC	B 180 EHD	B 185 APC	
Atego 3 (BM967) 921, 921 L	01/2010 -	B 180 APC	B 180 EHD	B 185 APC	
Atego 3 (BM967) 923 AF	01/2010 -	B 180 APC	B 180 EHD	B 185 APC	
Atego 3 (BM967) 923 F	01/2010 -	B 180 APC	B 180 EHD	B 185 APC	
Atego 3 (BM967) 923 K	01/2010 -	B 180 APC	B 180 EHD	B 185 APC	
Atego 3 (BM967) 923, 923 L	01/2010 -	B 180 APC	B 180 EHD	B 185 APC	
Atego 3 (BM967) 924 K	01/2010 -	B 180 APC	B 180 EHD	B 185 APC	
Atego 3 (BM967) 924, 924 L	01/2010 -	B 180 APC	B 180 EHD	B 185 APC	
Atego 3 (BM967) 927 AF	01/2010 -	B 180 APC	B 180 EHD	B 185 APC	
Atego 3 (BM967) 927 F	01/2010 -	B 180 APC	B 180 EHD	B 185 APC	
AXOR 1823	01/2002 - 10/2004	B 180 APC	B 180 EHD	B 185 APC	
AXOR 1823 K	01/2002 - 10/2004	B 180 APC	B 180 EHD	B 185 APC	
AXOR 1835 LS	01/2002 - 10/2004	B 180 APC	B 180 EHD	B 185 APC	
AXOR 1840 LS	01/2002 - 10/2004	B 180 APC	B 180 EHD	B 185 APC	

MARCHIO E MODELLO - MAKE AND MODEL MARQUE ET MODÈLE - MARKE UND MODELL MARCA Y MODELO - МАРКА И МОДЕЛЬ	Periodo Period	powerCUBE		energyCUBE	
		APC	EHD	APC	RST
MERCEDES-BENZ cont.					
AXOR 1843 LS	01/2002 - 10/2004	B 180 APC	B 180 EHD	B 185 APC	
AXOR 2523	01/2002 - 10/2004	B 180 APC	B 180 EHD	B 185 APC	
AXOR 2523 K	01/2002 - 10/2004	B 180 APC	B 180 EHD	B 185 APC	
AXOR 2528	01/2002 - 10/2004	B 180 APC	B 180 EHD	B 185 APC	
AXOR 2535 LS	01/2002 - 10/2004	B 180 APC	B 180 EHD	B 185 APC	
AXOR 2540 LS	01/2002 - 10/2004	B 180 APC	B 180 EHD	B 185 APC	
AXOR 2543 LS	01/2002 - 10/2004	B 180 APC	B 180 EHD	B 185 APC	
AXOR 2623 L	01/2002 - 10/2004	B 180 APC	B 180 EHD	B 185 APC	
AXOR 2628 B	01/2002 - 10/2004	B 180 APC	B 180 EHD	B 185 APC	
AXOR 2628 K	01/2002 - 10/2004	B 180 APC	B 180 EHD	B 185 APC	
AXOR 2628 L	01/2002 - 10/2004	B 180 APC	B 180 EHD	B 185 APC	
AXOR 3228 C	01/2002 - 10/2004	B 180 APC	B 180 EHD	B 185 APC	
AXOR 2 1824 A		B 180 APC	B 180 EHD	B 185 APC	
AXOR 2 1824 AK	10/2004 -	B 180 APC	B 180 EHD	B 185 APC	
AXOR 2 1824 K	10/2004 -	B 180 APC	B 180 EHD	B 185 APC	
AXOR 2 1824 LS	10/2004 -	B 180 APC	B 180 EHD	B 185 APC	
AXOR 2 1824, 1824 L	10/2004 -	B 180 APC	B 180 EHD	B 185 APC	
AXOR 2 1826 AK	10/2004 -	B 180 APC	B 180 EHD	B 185 APC	
AXOR 2 1826 K	10/2004 -	B 180 APC	B 180 EHD	B 185 APC	
AXOR 2 1826 LS	10/2004 -	B 180 APC	B 180 EHD	B 185 APC	
AXOR 2 1826, 1826 L	10/2004 -	B 180 APC	B 180 EHD	B 185 APC	
AXOR 2 1828 A, 1829 A	10/2004 -	B 180 APC	B 180 EHD	B 185 APC	
AXOR 2 1828 AK, 1829 AK	10/2004 -	B 180 APC	B 180 EHD	B 185 APC	
AXOR 2 1828 K, 1829 K	10/2004 -	B 180 APC	B 180 EHD	B 185 APC	
AXOR 2 1828 LS	10/1997 -	B 180 APC	B 180 EHD	B 185 APC	
AXOR 2 1829 LS	10/2004 -	B 180 APC	B 180 EHD	B 185 APC	
AXOR 2 1829, 1829 L	10/2004 -	B 180 APC	B 180 EHD	B 185 APC	
AXOR 2 1833 A	10/2004 -	B 180 APC	B 180 EHD	B 185 APC	
AXOR 2 1833 AK	10/2004 -	B 180 APC	B 180 EHD	B 185 APC	
AXOR 2 1833 K	10/2004 -	B 180 APC	B 180 EHD	B 185 APC	
AXOR 2 1833 LS	10/2004 -	B 180 APC	B 180 EHD	B 185 APC	
AXOR 2 1833, 1833 L	10/2004 -	B 180 APC	B 180 EHD	B 185 APC	
AXOR 2 1835 LS	01/2011 -	B 180 APC	B 180 EHD	B 185 APC	
AXOR 2 1836 LS	10/2004 -	B 180 APC	B 180 EHD	B 185 APC	
AXOR 2 1840 LS	10/2004 -	B 180 APC	B 180 EHD	B 185 APC	
AXOR 2 1843 LS	10/2004 -	B 180 APC	B 180 EHD	B 185 APC	
AXOR 2 1933	10/2004 -	B 180 APC	B 180 EHD	B 185 APC	
AXOR 2 1933 S	01/2011 -	B 180 APC	B 180 EHD	B 185 APC	
AXOR 2 2035 S	01/2011 -	B 180 APC	B 180 EHD	B 185 APC	
AXOR 2 2040 S	01/2011 -	B 180 APC	B 180 EHD	B 185 APC	
AXOR 2 2044 S	01/2011 -	B 180 APC	B 180 EHD	B 185 APC	
AXOR 2 2436 LS	10/2004 -	B 180 APC	B 180 EHD	B 185 APC	
AXOR 2 2440 LS	10/2004 -	B 180 APC	B 180 EHD	B 185 APC	
AXOR 2 2443 LS	10/2004 -	B 180 APC	B 180 EHD	B 185 APC	
AXOR 2 2523	01/2011 -	B 180 APC	B 180 EHD	B 185 APC	

MARCHIO E MODELLO - MAKE AND MODEL MARQUE ET MODÈLE - MARKE UND MODELL MARCA Y MODELO - МАРКА И МОДЕЛЬ	Periodo Period	powerCUBE		energyCUBE	
		APC	EHD	APC	RST
MERCEDES-BENZ cont.					
AXOR 2 2528 K, 2528 KL	01/2011 -	B 180 APC	B 180 EHD	B 185 APC	
AXOR 2 2529 L	10/2004 -	B 180 APC	B 180 EHD	B 185 APC	
AXOR 2 2533 L	10/2004 -	B 180 APC	B 180 EHD	B 185 APC	
AXOR 2 2535 S	10/2004 -	B 180 APC	B 180 EHD	B 185 APC	
AXOR 2 2536 L	10/2004 -	B 180 APC	B 180 EHD	B 185 APC	
AXOR 2 2540 L	10/2004 -	B 180 APC	B 180 EHD	B 185 APC	
AXOR 2 2540 S	10/2004 -	B 180 APC	B 180 EHD	B 185 APC	
AXOR 2 2543 L	10/2004 -	B 180 APC	B 180 EHD	B 185 APC	
AXOR 2 2543 S, 2543 LS	10/2004 -	B 180 APC	B 180 EHD	B 185 APC	
AXOR 2 2628 B, 2629 B	10/2004 -	B 180 APC	B 180 EHD	B 185 APC	
AXOR 2 2628 K, 2629 K	10/2004 -	B 180 APC	B 180 EHD	B 185 APC	
AXOR 2 2629	10/2004 -	B 180 APC	B 180 EHD	B 185 APC	
AXOR 2 2633	10/2004 -	B 180 APC	B 180 EHD	B 185 APC	
AXOR 2 2633 B	10/2004 -	B 180 APC	B 180 EHD	B 185 APC	
AXOR 2 2633 K	10/2004 -	B 180 APC	B 180 EHD	B 185 APC	
AXOR 2 2635 B	10/2005 -	B 180 APC	B 180 EHD	B 185 APC	
AXOR 2 2636	10/2004 -	B 180 APC	B 180 EHD	B 185 APC	
AXOR 2 2636 B	10/2004 -	B 180 APC	B 180 EHD	B 185 APC	
AXOR 2 2636 K	10/2004 -	B 180 APC	B 180 EHD	B 185 APC	
AXOR 2 2640	10/2004 -	B 180 APC	B 180 EHD	B 185 APC	
AXOR 2 2640 B	10/2004 -	B 180 APC	B 180 EHD	B 185 APC	
AXOR 2 2640 K	10/2004 -	B 180 APC	B 180 EHD	B 185 APC	
AXOR 2 2640 S	10/2004 -	B 180 APC	B 180 EHD	B 185 APC	
AXOR 2 2643	10/2004 -	B 180 APC	B 180 EHD	B 185 APC	
AXOR 2 2643 B	10/2004 -	B 180 APC	B 180 EHD	B 185 APC	
AXOR 2 2643 K	10/2004 -	B 180 APC	B 180 EHD	B 185 APC	
AXOR 2 2644 S	01/2011 -	B 180 APC	B 180 EHD	B 185 APC	
AXOR 2 2828 K	10/2004 -	B 180 APC	B 180 EHD	B 185 APC	
AXOR 2 2831	01/2011 -	B 180 APC	B 180 EHD	B 185 APC	
AXOR 2 3028 B	01/2011 -	B 180 APC	B 180 EHD	B 185 APC	
AXOR 2 3028 K	01/2011 -	B 180 APC	B 180 EHD	B 185 APC	
AXOR 2 3228	01/2011 -	B 180 APC	B 180 EHD	B 185 APC	
AXOR 2 3235	10/2004 -	B 180 APC	B 180 EHD	B 185 APC	
AXOR 2 3236 B	10/2004 -	B 180 APC	B 180 EHD	B 185 APC	
AXOR 2 3236 K	10/2004 -	B 180 APC	B 180 EHD	B 185 APC	
AXOR 2 3240	03/2005 -	B 180 APC	B 180 EHD	B 185 APC	
AXOR 2 3240 B	10/2004 -	B 180 APC	B 180 EHD	B 185 APC	
AXOR 2 3240 K	10/2004 -	B 180 APC	B 180 EHD	B 185 APC	
AXOR 2 3243	03/2005 -	B 180 APC	B 180 EHD	B 185 APC	
AXOR 2 3243 B	10/2004 -	B 180 APC	B 180 EHD	B 185 APC	
AXOR 2 3243 K	10/2004 -	B 180 APC	B 180 EHD	B 185 APC	
AXOR 2 3335	10/2004 -	B 180 APC	B 180 EHD	B 185 APC	
AXOR 2 3335 B	10/2004 - 10/2005	B 180 APC	B 180 EHD	B 185 APC	
AXOR 2 3335 K	06/2009 -	B 180 APC	B 180 EHD	B 185 APC	
AXOR 2 3335 S	09/2008 -	B 180 APC	B 180 EHD	B 185 APC	

MARCHIO E MODELLO - MAKE AND MODEL MARQUE ET MODÈLE - MARKE UND MODELL MARCA Y MODELO - МАРКА И МОДЕЛЬ	Periodo Period	powerCUBE		energyCUBE	
		APC	EHD	APC	RST
MERCEDES-BENZ cont.					
AXOR 2 3340	10/2004 -	B 180 APC	B 180 EHD	B 185 APC	
AXOR 2 3340 B	10/2004 - 10/2005	B 180 APC	B 180 EHD	B 185 APC	
AXOR 2 3340 B	10/2004 -	B 180 APC	B 180 EHD	B 185 APC	
AXOR 2 3340 K	10/2004 -	B 180 APC	B 180 EHD	B 185 APC	
AXOR 2 3340 S	06/2009 -	B 180 APC	B 180 EHD	B 185 APC	
AXOR 2 3343	10/2004 -	B 180 APC	B 180 EHD	B 185 APC	
AXOR 2 3344	01/2011 -	B 180 APC	B 180 EHD	B 185 APC	
AXOR 2 3344 K	01/2011 -	B 180 APC	B 180 EHD	B 185 APC	
AXOR 2 3344 S	01/2011 -	B 180 APC	B 180 EHD	B 185 APC	
AXOR 2 3535 K	06/2009 -	B 180 APC	B 180 EHD	B 185 APC	
AXOR 2 4135 B	10/2005 -	B 180 APC	B 180 EHD	B 185 APC	
AXOR 2 4135 K	06/2009 -	B 180 APC	B 180 EHD	B 185 APC	
AXOR 2 4140	01/2011 -	B 180 APC	B 180 EHD	B 185 APC	
AXOR 2 4140 B	01/2011 -	B 180 APC	B 180 EHD	B 185 APC	
AXOR 2 4140 K	06/2009 -	B 180 APC	B 180 EHD	B 185 APC	
AXOR 2 4143 B		B 180 APC	B 180 EHD	B 185 APC	
AXOR 2 4143 K	06/2009 -	B 180 APC	B 180 EHD	B 185 APC	
AXOR 2 4144	01/2011 -	B 180 APC	B 180 EHD	B 185 APC	
AXOR 2 4144 K	01/2011 -	B 180 APC	B 180 EHD	B 185 APC	
C8t56Eop 1823 AK	05/1998 - 09/2004	A 135 APC	A 140 EHD / A 120 EHD		
C8t56Eop 1823 K	05/1998 - 09/2004	A 135 APC	A 140 EHD / A 120 EHD		
C8t56Eop 1823 LS	05/1998 - 09/2004	A 135 APC	A 140 EHD / A 120 EHD		
C8t56Eop 1823,1823 L	01/1998 - 09/2004	A 135 APC	A 140 EHD / A 120 EHD		
C8t56Eop 1828 A	05/1998 - 09/2004	A 135 APC	A 140 EHD / A 120 EHD		
C8t56Eop 1828 AK	05/1998 - 09/2004	A 135 APC	A 140 EHD / A 120 EHD		
C8t56Eop 1828 K	05/1998 - 09/2004	A 135 APC	A 140 EHD / A 120 EHD		
C8t56Eop 1828 LS	05/1998 - 09/2004	A 135 APC	A 140 EHD / A 120 EHD		
C8t56Eop 1828,1828 L	05/1998 - 09/2004	A 135 APC	A 140 EHD / A 120 EHD		
C8t56Eop 2523 L	05/1998 - 09/2004	A 135 APC	A 140 EHD / A 120 EHD		
C8t56Eop 2528 L	05/1998 - 09/2004	A 135 APC	A 140 EHD / A 120 EHD		
C8t56Eop 2628	05/1998 - 09/2004	A 135 APC	A 140 EHD / A 120 EHD		
C8t56Eop 2628 B	05/1998 - 09/2004	A 135 APC	A 140 EHD / A 120 EHD		
C8t56Eop 2628 K	05/1998 - 09/2004	A 135 APC	A 140 EHD / A 120 EHD		
CAPACITY (O 530 GL) CapaCity	04/2007 -	CX 225 APC		CX 220 APC	
CITARO (O 530) Citaro		CX 225 APC	CX 200 EHD	CX 220 APC	
CITARO (O 530) Citaro	01/1998 -	CX 225 APC	CX 200 EHD	CX 220 APC	
CITARO (O 530) Citaro	04/1999 -	CX 225 APC	CX 200 EHD	CX 220 APC	
CITARO (O 530) Citaro BZ	01/2002 -	CX 225 APC	CX 200 EHD	CX 220 APC	
CITARO (O 530) Citaro G	01/1998 -	CX 225 APC	CX 200 EHD	CX 220 APC	
CITARO (O 530) Citaro G	01/1999 -	CX 225 APC	CX 200 EHD	CX 220 APC	
CITARO (O 530) Citaro G	04/2000 -	CX 225 APC	CX 200 EHD	CX 220 APC	
CITARO (O 530) Citaro G, Citaro LÜ	01/1998 -	CX 225 APC		CX 220 APC	
CITARO (O 530) Citaro N	01/1998 -	CX 225 APC	CX 200 EHD	CX 220 APC	
CITARO (O 530) Citaro N	01/1999 -	CX 225 APC	CX 200 EHD	CX 220 APC	
CITARO (O 530) Citaro N	06/2000 -	CX 225 APC	CX 200 EHD	CX 220 APC	

MARCHIO E MODELLO - MAKE AND MODEL MARQUE ET MODÈLE - MARKE UND MODELL MARCA Y MODELO - МАРКА И МОДЕЛЬ	Periodo Period	powerCUBE		energyCUBE	
		APC	EHD	APC	RST
MERCEDES-BENZ cont.					
CITARO (O 530) Citaro NG	04/2000 -	CX 225 APC	CX 200 EHD	CX 220 APC	
CITO (O 520) 177 kW	06/1999 -	CX 225 APC	CX 200 EHD	CX 220 APC	
CONECTO (O 345) CONECTO 12M	11/2001 -	CX 225 APC		CX 220 APC	
CONECTO (O 345) CONECTO 18M	11/2001 -	CX 225 APC		CX 220 APC	
CONECTO (O 345) CONECTO C, H, M, UE	11/2001 -	CX 225 APC		CX 220 APC	
CONECTO (O 345) CONECTO C, H, UE	11/2001 -	CX 225 APC		CX 220 APC	
ECONIC 1823 LL	03/1998 -	B 180 APC	B 180 EHD	B 185 APC	
ECONIC 1824 LL		B 180 APC	B 180 EHD	B 185 APC	
ECONIC 1828 L	10/2000 -	B 180 APC	B 180 EHD	B 185 APC	
ECONIC 1828 LL		B 180 APC	B 180 EHD	B 185 APC	
ECONIC 1828 LL	03/1998 -	B 180 APC	B 180 EHD	B 185 APC	
ECONIC 1828 LLS		B 180 APC	B 180 EHD	B 185 APC	
ECONIC 1828 LS	10/2004 -	B 180 APC	B 180 EHD	B 185 APC	
ECONIC 1829 LL		B 180 APC	B 180 EHD	B 185 APC	
ECONIC 1833 LL		B 180 APC	B 180 EHD	B 185 APC	
ECONIC 1833 LS	10/2007 -	B 180 APC	B 180 EHD	B 185 APC	
ECONIC 2624 L	03/1998 -	B 180 APC	B 180 EHD	B 185 APC	
ECONIC 2628	01/1998 -	B 180 APC	B 180 EHD	B 185 APC	
ECONIC 2628 L		B 180 APC	B 180 EHD	B 185 APC	
ECONIC 2628 L	10/2000 -	B 180 APC	B 180 EHD	B 185 APC	
ECONIC 2628 L	10/2001 -	B 180 APC	B 180 EHD	B 185 APC	
ECONIC 2628 LL	03/1998 -	B 180 APC	B 180 EHD	B 185 APC	
ECONIC 2629 LL		B 180 APC	B 180 EHD	B 185 APC	
ECONIC 2633 L	10/2001 -	B 180 APC	B 180 EHD	B 185 APC	
ECONIC 2633 LL		B 180 APC	B 180 EHD	B 185 APC	
ECONIC 3233 LL		B 180 APC	B 180 EHD	B 185 APC	
ECONIC 2 1830 LL	04/2013 -	B 180 APC		B 185 APC	
ECONIC 2 1835 LL	04/2013 -	B 180 APC		B 185 APC	
ECONIC 2 2630 LL	04/2013 -	B 180 APC		B 185 APC	
ECONIC 2 2635 LL	04/2013 -	B 180 APC		B 185 APC	
INTEGRO (O 550) Integro , Integro M	01/2006 -	CX 225 APC		CX 220 APC	
INTEGRO (O 550) Integro L	01/2006 -	CX 225 APC		CX 220 APC	
INTEGRO (O 550) Integro, Integro M	01/2006 -	CX 225 APC		CX 220 APC	
INTOURO Intouro, Intouro E, Intouro M, Intouro ME	01/2005 -	CX 225 APC		CX 220 APC	
LK/LN2 1114 A	02/1987 - 12/1998		D11 135 EHD		
LK/LN2 1114 AK	02/1987 - 12/1998		D11 135 EHD		
LK/LN2 1114 K	03/1984 - 12/1998		D11 135 EHD		
LK/LN2 1114 S	03/1984 - 12/1998		D11 135 EHD		
LK/LN2 1114,1114 L	01/1984 - 12/1998		D11 135 EHD		
LK/LN2 1117 A	06/1987 - 12/1998		D11 135 EHD		
LK/LN2 1117 AK	04/1984 - 12/1998		D11 135 EHD		
LK/LN2 1117 K	03/1996 - 12/1998		D11 135 EHD		
LK/LN2 1117 K	04/1984 - 12/1998		D11 135 EHD		
LK/LN2 1117 LO	03/1996 - 12/1998		D11 135 EHD		
LK/LN2 1117 O,1117 LO	01/1984 - 12/1998		D11 135 EHD		

MARCHIO E MODELLO - MAKE AND MODEL MARQUE ET MODÈLE - MARKE UND MODELL MARCA Y MODELO - МАРКА И МОДЕЛЬ	Periodo Period	powerCUBE		energyCUBE	
		APC	EHD	APC	RST
MERCEDES-BENZ cont.					
LK/LN2 1117 S	03/1996 - 12/1998		D11 135 EHD		
LK/LN2 1117 S,1117 LS	01/1984 - 12/1998		D11 135 EHD		
LK/LN2 1117,1117 L	01/1984 - 12/1998		D11 135 EHD		
LK/LN2 1120 AF	02/1987 - 12/1998		D11 135 EHD		
LK/LN2 1120 F	02/1990 - 12/1998		D11 135 EHD		
LK/LN2 1120 L	08/1984 - 12/1998		D11 135 EHD		
LK/LN2 1120 O,1120 LO	01/1984 - 12/1998		D11 135 EHD		
LK/LN2 1120 S,1120 LS	01/1984 - 12/1998		D11 135 EHD		
LK/LN2 1120,1120 L	01/1984 - 12/1998		D11 135 EHD		
LK/LN2 1124 AF	03/1992 - 12/1998		D11 135 EHD		
LK/LN2 1124 F	03/1992 - 12/1998		D11 135 EHD		
LK/LN2 1214 A	01/1984 - 12/1998		D11 135 EHD		
LK/LN2 1217 KO	03/1994 - 12/1998		D11 135 EHD		
LK/LN2 1314	07/1984 - 12/1998		D11 135 EHD		
LK/LN2 1314 AK	06/1987 - 12/1998		D11 135 EHD		
LK/LN2 1314 K	07/1984 - 12/1998		D11 135 EHD		
LK/LN2 1314 KO	07/1984 - 12/1998		D11 135 EHD		
LK/LN2 1317 AK	08/1984 - 12/1998		D11 135 EHD		
LK/LN2 1317 AK	12/1992 - 12/1998		D11 135 EHD		
LK/LN2 1317 K	03/1996 - 12/1998		D11 135 EHD		
LK/LN2 1317 K	07/1984 - 12/1998		D11 135 EHD		
LK/LN2 1317 KO	03/1994 - 12/1998		D11 135 EHD		
LK/LN2 1317 KO	03/1996 - 12/1998		D11 135 EHD		
LK/LN2 1317 LS	03/1996 - 12/1998		D11 135 EHD		
LK/LN2 1317 S,1317 LS	01/1984 - 12/1998		D11 135 EHD		
LK/LN2 1317,1317 L	01/1984 - 12/1998		D11 135 EHD		
LK/LN2 1320 AK	12/1992 - 12/1998		D11 135 EHD		
LK/LN2 1320 L	12/1992 - 12/1998		D11 135 EHD		
LK/LN2 1320 S,1320 LS	01/1984 - 12/1998		D11 135 EHD		
LK/LN2 1320,1320 L	01/1984 - 12/1998		D11 135 EHD		
LK/LN2 1324 L	01/1991 - 12/1998		D11 135 EHD		
LK/LN2 1324 S,1324 LS	01/1984 - 12/1998		D11 135 EHD		
LK/LN2 1324,1324 L	01/1984 - 12/1998		D11 135 EHD		
LK/LN2 1514 K	01/1989 - 12/1998		D11 135 EHD		
LK/LN2 1514,1514 L	01/1984 - 12/1998		D11 135 EHD		
LK/LN2 1517 K	01/1989 - 12/1998		D11 135 EHD		
LK/LN2 1517 K	03/1996 - 12/1998		D11 135 EHD		
LK/LN2 1517,1517 L	01/1984 - 12/1998		D11 135 EHD		
LK/LN2 1520,1520 L	01/1984 - 12/1998		D11 135 EHD		
LK/LN2 1524,1524 L	01/1984 - 12/1998		D11 135 EHD		
LK/LN2 1724	01/1984 - 12/1998		D11 135 EHD		
LK/LN2 2020 L	01/1984 - 12/1998		D11 135 EHD		
LK/LN2 2024 L	01/1984 - 12/1998		D11 135 EHD		
LK/LN2 709	03/1984 - 12/1998		D11 135 EHD		
LK/LN2 709 K	03/1984 - 10/1990		D11 135 EHD		

MARCHIO E MODELLO - MAKE AND MODEL MARQUE ET MODÈLE - MARKE UND MODELL MARCA Y MODELO - МАРКА И МОДЕЛЬ	Periodo Period	powerCUBE		energyCUBE	
		APC	EHD	APC	RST
MERCEDES-BENZ cont.					
LK/LN2 711	03/1994 - 12/1998		D11 135 EHD		
LK/LN2 711	03/1996 - 12/1998		D11 135 EHD		
LK/LN2 809	03/1984 - 12/1998		D11 135 EHD		
LK/LN2 809 K	03/1984 - 12/1998		D11 135 EHD		
LK/LN2 811	03/1994 - 12/1998		D11 135 EHD		
LK/LN2 811	03/1996 - 12/1998		D11 135 EHD		
LK/LN2 811 K	03/1994 - 12/1998		D11 135 EHD		
LK/LN2 811 K	03/1996 - 12/1998		D11 135 EHD		
LK/LN2 814 F	03/1994 - 12/1998		D11 135 EHD		
LK/LN2 814 F	03/1996 - 12/1998		D11 135 EHD		
LK/LN2 814 F	05/1986 - 12/1998		D11 135 EHD		
LK/LN2 814 K	03/1984 - 12/1998		D11 135 EHD		
LK/LN2 814 K	03/1994 - 12/1998		D11 135 EHD		
LK/LN2 814 K	03/1996 - 12/1998		D11 135 EHD		
LK/LN2 814 LO	03/1996 - 12/1998		D11 135 EHD		
LK/LN2 814 O,814 LO	01/1984 - 12/1998		D11 135 EHD		
LK/LN2 814 S	03/1984 - 12/1998		D11 135 EHD		
LK/LN2 814 S	03/1994 - 12/1998		D11 135 EHD		
LK/LN2 814 S	03/1996 - 12/1998		D11 135 EHD		
LK/LN2 814,814 L	01/1984 - 12/1998		D11 135 EHD		
LK/LN2 814,814L	01/1984 - 12/1998		D11 135 EHD		
LK/LN2 817 F	03/1984 - 12/1998		D11 135 EHD		
LK/LN2 817 F	03/1996 - 12/1998		D11 135 EHD		
LK/LN2 817 K	01/1986 - 12/1998		D11 135 EHD		
LK/LN2 817 K	03/1996 - 12/1998		D11 135 EHD		
LK/LN2 817 LO	03/1996 - 12/1998		D11 135 EHD		
LK/LN2 817 O,817 LO	01/1984 - 12/1998		D11 135 EHD		
LK/LN2 817 S,817 LS	01/1984 - 12/1998		D11 135 EHD		
LK/LN2 817,817 L	01/1984 - 12/1998		D11 135 EHD		
LK/LN2 817,817 L	03/1996 - 12/1998		D11 135 EHD		
LK/LN2 914	03/1984 - 12/1998		D11 135 EHD		
LK/LN2 914 AK	02/1987 - 12/1998		D11 135 EHD		
LK/LN2 914 K	03/1984 - 12/1998		D11 135 EHD		
LK/LN2 914 KO	01/1987 - 12/1998		D11 135 EHD		
LK/LN2 917	03/1994 - 12/1998		D11 135 EHD		
LK/LN2 917	03/1996 - 12/1998		D11 135 EHD		
LK/LN2 917 AF	02/1987 - 12/1998		D11 135 EHD		
LK/LN2 917 AK	03/1994 - 12/1998		D11 135 EHD		
LK/LN2 917 K	03/1994 - 12/1998		D11 135 EHD		
LK/LN2 917 K	03/1996 - 12/1998		D11 135 EHD		
LK/LN2 917 KO	03/1994 - 12/1998		D11 135 EHD		
LK/LN2 917 KO	03/1996 - 12/1998		D11 135 EHD		
LK/LN2 O 1114 ,O 1114 L	01/1984 - 12/1998		D11 135 EHD		
LK/LN2 O 814 ,O 814 L	01/1984 - 12/1998		D11 135 EHD		
LP LP 1013	11/1976 - 12/1984		D11 135 EHD		

MARCHIO E MODELLO - MAKE AND MODEL MARQUE ET MODÈLE - MARKE UND MODELL MARCA Y MODELO - МАРКА И МОДЕЛЬ	Periodo Period	powerCUBE		energyCUBE	
		APC	EHD	APC	RST
MERCEDES-BENZ cont.					
LP LP 1113	01/1980 - 12/1984		D11 135 EHD		
LP LP 608,LPL 608	09/1963 - 12/1984		D11 135 EHD		
LP LP 709,LPL 709	09/1963 - 12/1984		D11 135 EHD		
LP LP 808,LPL 808	09/1963 - 12/1984		D11 135 EHD		
LP LP 809,LPL 809	09/1963 - 12/1984		D11 135 EHD		
LP LP 811	10/1969 - 02/1973		D11 135 EHD		
LP LP 813,LPL 813	09/1963 - 12/1984		D11 135 EHD		
LP LP 911 B	01/1967 - 03/1977		D11 135 EHD		
LP LP 913,LPL 913	09/1963 - 12/1984		D11 135 EHD		
LP LPK 1013	11/1976 - 12/1984		D11 135 EHD		
LP LPK 1113	01/1981 -		D11 135 EHD		
LP LPK 608	10/1969 - 10/1977		D11 135 EHD		
LP LPK 709	11/1977 - 12/1984		D11 135 EHD		
LP LPK 808	10/1969 - 10/1977		D11 135 EHD		
LP LPK 809	11/1977 - 12/1984		D11 135 EHD		
LP LPK 811	03/1973 - 12/1984		D11 135 EHD		
LP LPK 813	03/1973 - 12/1984		D11 135 EHD		
LP LPK 913	01/1967 - 12/1984		D11 135 EHD		
LP LPKF 608	09/1963 - 12/1984		D11 135 EHD		
LP LPKF 709	11/1977 - 12/1984		D11 135 EHD		
LP LPKF 808	10/1969 - 10/1977		D11 135 EHD		
LP LPKO 608	02/1966 - 07/1977		D11 135 EHD		
LP LPO 608	10/1969 - 10/1977		D11 135 EHD		
LP LPO 709	11/1977 - 12/1984		D11 135 EHD		
LP LPO 808, LPO 809	09/1967 - 10/1977		D11 135 EHD		
LP LPO 811	10/1969 -		D11 135 EHD		
LP LPS 608,LPLS 608	09/1963 - 12/1984		D11 135 EHD		
LP LPS 709,LPLS 709	09/1963 - 12/1984		D11 135 EHD		
LP LPS 811	10/1969 - 02/1973		D11 135 EHD		
LP LPS 813,LPLS 813	09/1963 - 12/1984		D11 135 EHD		
LP LPS 911 B	01/1967 - 03/1977		D11 135 EHD		
LP LPS 913	10/1969 - 12/1984		D11 135 EHD		
MB-TRAC 1000	12/1982 - 12/1987	B 180 APC	B 180 EHD / B 160 EHD	B 185 APC	
MB-TRAC 1000, 1100	02/1987 - 12/1991	B 180 APC	B 180 EHD / B 160 EHD	B 185 APC	
MB-TRAC 1100	03/1979 - 08/1987	B 180 APC	B 180 EHD / B 160 EHD	B 185 APC	
MB-TRAC 1300	03/1976 - 08/1987	B 180 APC	B 180 EHD / B 160 EHD	B 185 APC	
MB-TRAC 1300, 1400	02/1982 - 12/1991	B 180 APC	B 180 EHD / B 160 EHD	B 185 APC	
MB-TRAC 1500	07/1980 - 12/1987	B 180 APC	B 180 EHD / B 160 EHD	B 185 APC	
MB-TRAC 1600	06/1990 - 12/1991	B 180 APC	B 180 EHD / B 160 EHD	B 185 APC	
MB-TRAC 1800	06/1990 - 12/1991	B 180 APC	B 180 EHD / B 160 EHD	B 185 APC	
MB-TRAC 65/70, 700, 800	07/1973 - 12/1975	A 135 APC	A 140 EHD / A 120 EHD		
MB-TRAC 700, 800	02/1987 - 12/1991	A 135 APC	A 140 EHD / A 120 EHD		
MB-TRAC 900	03/1987 - 12/1991	A 135 APC	A 140 EHD / A 120 EHD		
MB-TRAC 900	09/1981 - 12/1982	A 135 APC	A 140 EHD / A 120 EHD		
MK 1222	07/1989 - 08/1994	A 135 APC	A 140 EHD / A 120 EHD		

MARCHIO E MODELLO - MAKE AND MODEL MARQUE ET MODÈLE - MARKE UND MODELL MARCA Y MODELO - МАРКА И МОДЕЛЬ	Periodo Period	powerCUBE		energyCUBE	
		APC	EHD	APC	RST
MERCEDES-BENZ cont.					
MK 1222 A, 1222 LA	09/1989 - 07/1994	A 135 APC	A 140 EHD / A 120 EHD		
MK 1222 AF	09/1989 - 09/1993	A 135 APC	A 140 EHD / A 120 EHD		
MK 1222 F	07/1989 - 08/1994	A 135 APC	A 140 EHD / A 120 EHD		
MK 1222 S, 1222 LS	07/1989 - 08/1994	A 135 APC	A 140 EHD / A 120 EHD		
MK 1224 AF	02/1993 - 09/1996	A 135 APC	A 140 EHD / A 120 EHD		
MK 1224 F	07/1989 - 08/1994	A 135 APC	A 140 EHD / A 120 EHD		
MK 1226 AF	02/1990 - 09/1993	A 135 APC	A 140 EHD / A 120 EHD		
MK 1226 AF	02/1993 - 09/1996	A 135 APC	A 140 EHD / A 120 EHD		
MK 1227 A	01/1992 - 07/1992	A 135 APC	A 140 EHD / A 120 EHD		
MK 1227 AF, 1227 LAF	01/1992 - 07/1992	A 135 APC	A 140 EHD / A 120 EHD		
MK 1231 AF	01/1992 - 09/1996	A 135 APC	A 140 EHD / A 120 EHD		
MK 1234 AF	01/1992 - 09/1996	A 135 APC	A 140 EHD / A 120 EHD		
MK 1417	07/1989 - 09/1996	A 135 APC	A 140 EHD / A 120 EHD		
MK 1417 A	09/1989 - 09/1996	A 135 APC	A 140 EHD / A 120 EHD		
MK 1417 AK	09/1989 - 09/1996	A 135 APC	A 140 EHD / A 120 EHD		
MK 1417 K	07/1989 - 09/1996	A 135 APC	A 140 EHD / A 120 EHD		
MK 1420 AK	09/1989 - 09/1996	A 135 APC	A 140 EHD / A 120 EHD		
MK 1420 LS	02/1990 - 09/1996	A 135 APC	A 140 EHD / A 120 EHD		
MK 1420,1420 L	12/1987 - 09/1996	A 135 APC	A 140 EHD / A 120 EHD		
MK 1422	02/1993 - 08/1994	A 135 APC	A 140 EHD / A 120 EHD		
MK 1422 F	02/1993 - 08/1994	A 135 APC	A 140 EHD / A 120 EHD		
MK 1422 F	03/1993 - 08/1994	A 135 APC	A 140 EHD / A 120 EHD		
MK 1422 F	07/1989 - 09/1993	A 135 APC	A 140 EHD / A 120 EHD		
MK 1422 LS	02/1993 - 08/1994	A 135 APC	A 140 EHD / A 120 EHD		
MK 1422 S,1422 LS	12/1987 - 09/1996	A 135 APC	A 140 EHD / A 120 EHD		
MK 1422,1422 L	12/1987 - 09/1996	A 135 APC	A 140 EHD / A 120 EHD		
MK 1424	07/1989 - 09/1996	A 135 APC	A 140 EHD / A 120 EHD		
MK 1424 S,1424 LS	12/1987 - 09/1996	A 135 APC	A 140 EHD / A 120 EHD		
MK 1424,1424 L	12/1987 - 09/1996	A 135 APC	A 140 EHD / A 120 EHD		
MK 1426 S,1426 LS	12/1987 - 09/1996	A 135 APC	A 140 EHD / A 120 EHD		
MK 1427	02/1993 - 09/1996	A 135 APC	A 140 EHD / A 120 EHD		
MK 1427 F	02/1993 - 09/1996	A 135 APC	A 140 EHD / A 120 EHD		
MK 1427 L	12/1987 - 09/1996	A 135 APC	A 140 EHD / A 120 EHD		
MK 1427 LS	02/1993 - 09/1996	A 135 APC	A 140 EHD / A 120 EHD		
MK 1427 S, 1427 LS	02/1993 - 09/1996	A 135 APC	A 140 EHD / A 120 EHD		
MK 1429 AF	01/1992 - 09/1996	A 135 APC	A 140 EHD / A 120 EHD		
MK 1431	12/1987 - 08/1996	A 135 APC	A 140 EHD / A 120 EHD		
MK 1431 F	12/1987 - 08/1996	A 135 APC	A 140 EHD / A 120 EHD		
MK 1624 S	12/1987 - 09/1996	A 135 APC	A 140 EHD / A 120 EHD		
MK 1627 AF	01/1992 - 09/1996	A 135 APC	A 140 EHD / A 120 EHD		
MK 1717 AK	09/1989 - 08/1994	A 135 APC	A 140 EHD / A 120 EHD		
MK 1717 K	09/1989 - 08/1994	A 135 APC	A 140 EHD / A 120 EHD		
MK 1717,1717 L	12/1987 - 09/1996	A 135 APC	A 140 EHD / A 120 EHD		
MK 1720 L	12/1988 - 08/1994	A 135 APC	A 140 EHD / A 120 EHD		
MK 1720 S	02/1990 - 08/1994	A 135 APC	A 140 EHD / A 120 EHD		

MARCHIO E MODELLO - MAKE AND MODEL MARQUE ET MODÈLE - MARKE UND MODELL MARCA Y MODELO - МАРКА И МОДЕЛЬ	Periodo Period	powerCUBE		energyCUBE	
		APC	EHD	APC	RST
MERCEDES-BENZ <i>cont.</i>					
MK 1720,1720 L	12/1987 - 09/1996	A 135 APC	A 140 EHD / A 120 EHD		
MK 1722	08/1988 - 08/1994	A 135 APC	A 140 EHD / A 120 EHD		
MK 1722	12/1988 - 08/1994	A 135 APC	A 140 EHD / A 120 EHD		
MK 1722 AK	12/1988 - 08/1994	A 135 APC	A 140 EHD / A 120 EHD		
MK 1722 K	12/1988 - 08/1994	A 135 APC	A 140 EHD / A 120 EHD		
MK 1722 L	12/1988 - 08/1994	A 135 APC	A 140 EHD / A 120 EHD		
MK 1722 S	12/1988 - 08/1994	A 135 APC	A 140 EHD / A 120 EHD		
MK 1722, 1722 L, 1722 LL	08/1988 - 08/1994	A 135 APC	A 140 EHD / A 120 EHD		
MK 1722,1722 L, 1722 LL	12/1987 - 09/1996	A 135 APC	A 140 EHD / A 120 EHD		
MK 1726 AK	06/1989 - 08/1994	A 135 APC	A 140 EHD / A 120 EHD		
MK 1726 K	12/1988 - 08/1994	A 135 APC	A 140 EHD / A 120 EHD		
MK 1726 L, 1726 LL	12/1988 - 08/1994	A 135 APC	A 140 EHD / A 120 EHD		
MK 1726 LL	12/1987 - 09/1996	A 135 APC	A 140 EHD / A 120 EHD		
MK 1726 S,1726 LS	12/1987 - 09/1996	A 135 APC	A 140 EHD / A 120 EHD		
MK 1726,1726 L, 1726 LL	12/1987 - 09/1996	A 135 APC	A 140 EHD / A 120 EHD		
MK 1727 L	12/1988 - 08/1994	A 135 APC	A 140 EHD / A 120 EHD		
MK 1729	12/1987 - 09/1996	A 135 APC	A 140 EHD / A 120 EHD		
MK 1729 LS	12/1987 - 09/1996	A 135 APC	A 140 EHD / A 120 EHD		
MK 1733 S,1733 LS	12/1987 - 09/1996	A 135 APC	A 140 EHD / A 120 EHD		
MK 1733,1733 L, 1734 L	12/1987 - 09/1996	A 135 APC	A 140 EHD / A 120 EHD		
MK 1820 AK	07/1993 - 09/1996	A 135 APC	A 140 EHD / A 120 EHD		
MK 1820 K	05/1992 - 09/1996	A 135 APC	A 140 EHD / A 120 EHD		
MK 1820,1820 L	12/1987 - 09/1996	A 135 APC	A 140 EHD / A 120 EHD		
MK 1824	01/1994 - 09/1996	A 135 APC	A 140 EHD / A 120 EHD		
MK 1824	08/1992 - 09/1996	A 135 APC	A 140 EHD / A 120 EHD		
MK 1824	12/1988 - 08/1994	A 135 APC	A 140 EHD / A 120 EHD		
MK 1824 AK	01/1994 - 09/1996	A 135 APC	A 140 EHD / A 120 EHD		
MK 1824 AK	08/1992 - 09/1996	A 135 APC	A 140 EHD / A 120 EHD		
MK 1824 K	01/1994 - 09/1996	A 135 APC	A 140 EHD / A 120 EHD		
MK 1824 K	08/1992 - 09/1996	A 135 APC	A 140 EHD / A 120 EHD		
MK 1824,1824 L	12/1987 - 09/1996	A 135 APC	A 140 EHD / A 120 EHD		
MK 1827 AK	08/1992 - 09/1996	A 135 APC	A 140 EHD / A 120 EHD		
MK 1827 K	01/1994 - 09/1996	A 135 APC	A 140 EHD / A 120 EHD		
MK 1827 S,1827 LS	12/1987 - 09/1996	A 135 APC	A 140 EHD / A 120 EHD		
MK 1827,1827 L	12/1987 - 09/1996	A 135 APC	A 140 EHD / A 120 EHD		
MK 1831 K	12/1988 - 08/1994	A 135 APC	A 140 EHD / A 120 EHD		
MK 1831 S,1831 LS	12/1987 - 09/1996	A 135 APC	A 140 EHD / A 120 EHD		
MK 1831,1831 L	12/1987 - 09/1996	A 135 APC	A 140 EHD / A 120 EHD		
MK 1834 S,1834 LS	12/1987 - 09/1996	A 135 APC	A 140 EHD / A 120 EHD		
MK 1834,1834 L	12/1987 - 09/1996	A 135 APC	A 140 EHD / A 120 EHD		
MK 1926	12/1987 - 09/1996	A 135 APC	A 140 EHD / A 120 EHD		
MK 2320 L	12/1987 - 09/1996	A 135 APC	A 140 EHD / A 120 EHD		
MK 2327 L	12/1987 - 09/1996	A 135 APC	A 140 EHD / A 120 EHD		
MK 2420,2420 L	12/1987 - 09/1996	A 135 APC	A 140 EHD / A 120 EHD		
MK 2422	09/1989 - 08/1994	A 135 APC	A 140 EHD / A 120 EHD		

MARCHIO E MODELLO - MAKE AND MODEL MARQUE ET MODÈLE - MARKE UND MODELL MARCA Y MODELO - МАРКА И МОДЕЛЬ	Periodo Period	powerCUBE		energyCUBE	
		APC	EHD	APC	RST
MERCEDES-BENZ cont.					
MK 2422 , 2422 L	09/1989 - 08/1994	A 135 APC	A 140 EHD / A 120 EHD		
MK 2422 B	09/1989 - 08/1994	A 135 APC	A 140 EHD / A 120 EHD		
MK 2422 K	09/1989 - 08/1994	A 135 APC	A 140 EHD / A 120 EHD		
MK 2422 L	12/1987 - 09/1996	A 135 APC	A 140 EHD / A 120 EHD		
MK 2422, 2422 L	09/1989 - 08/1994	A 135 APC	A 140 EHD / A 120 EHD		
MK 2422,2422 L	12/1987 - 09/1996	A 135 APC	A 140 EHD / A 120 EHD		
MK 2426	01/1990 - 08/1994	A 135 APC	A 140 EHD / A 120 EHD		
MK 2426	12/1987 - 09/1996	A 135 APC	A 140 EHD / A 120 EHD		
MK 2426 B	02/1990 - 08/1994	A 135 APC	A 140 EHD / A 120 EHD		
MK 2426 L	02/1990 - 08/1994	A 135 APC	A 140 EHD / A 120 EHD		
MK 2426 L	12/1987 - 09/1996	A 135 APC	A 140 EHD / A 120 EHD		
MK 2426, 2426 L	02/1990 - 08/1994	A 135 APC	A 140 EHD / A 120 EHD		
MK 2427 B	02/1990 - 08/1994	A 135 APC	A 140 EHD / A 120 EHD		
MK 2427 L	12/1987 - 09/1996	A 135 APC	A 140 EHD / A 120 EHD		
MK 2429	12/1987 - 09/1996	A 135 APC	A 140 EHD / A 120 EHD		
MK 2431	12/1987 - 09/1996	A 135 APC	A 140 EHD / A 120 EHD		
MK 2433 K	09/1989 - 07/1992	A 135 APC	A 140 EHD / A 120 EHD		
MK 2433 L	12/1987 - 09/1996	A 135 APC	A 140 EHD / A 120 EHD		
MK 2433 S	12/1987 - 09/1996	A 135 APC	A 140 EHD / A 120 EHD		
MK 2433 S,2433 LS	12/1987 - 09/1996	A 135 APC	A 140 EHD / A 120 EHD		
MK 2433,2433 L, 2434 L	12/1987 - 09/1996	A 135 APC	A 140 EHD / A 120 EHD		
MK 2522 L	12/1987 - 09/1996	A 135 APC	A 140 EHD / A 120 EHD		
MK 2524	01/1994 - 09/1996	A 135 APC	A 140 EHD / A 120 EHD		
MK 2524	06/1992 - 09/1996	A 135 APC	A 140 EHD / A 120 EHD		
MK 2524 K	01/1994 - 09/1996	A 135 APC	A 140 EHD / A 120 EHD		
MK 2524 K	06/1992 - 09/1996	A 135 APC	A 140 EHD / A 120 EHD		
MK 2524 L	12/1987 - 09/1996	A 135 APC	A 140 EHD / A 120 EHD		
MK 2524,2524 L	12/1987 - 09/1996	A 135 APC	A 140 EHD / A 120 EHD		
MK 2527	01/1994 - 09/1996	A 135 APC	A 140 EHD / A 120 EHD		
MK 2527	10/1993 - 09/1996	A 135 APC	A 140 EHD / A 120 EHD		
MK 2527 B	01/1994 - 09/1996	A 135 APC	A 140 EHD / A 120 EHD		
MK 2527 B	03/1991 - 09/1996	A 135 APC	A 140 EHD / A 120 EHD		
MK 2527 K	01/1994 - 09/1996	A 135 APC	A 140 EHD / A 120 EHD		
MK 2527 K	10/1993 - 09/1996	A 135 APC	A 140 EHD / A 120 EHD		
MK 2527 L	01/1994 - 09/1996	A 135 APC	A 140 EHD / A 120 EHD		
MK 2527 L	03/1991 - 08/1994	A 135 APC	A 140 EHD / A 120 EHD		
MK 2527 L	09/1992 - 09/1996	A 135 APC	A 140 EHD / A 120 EHD		
MK 2527 L	12/1987 - 09/1996	A 135 APC	A 140 EHD / A 120 EHD		
MK 2531 B	12/1987 - 09/1996	A 135 APC	A 140 EHD / A 120 EHD		
MK 2531 L	12/1987 - 09/1996	A 135 APC	A 140 EHD / A 120 EHD		
MK 2531,2531 L	12/1987 - 09/1996	A 135 APC	A 140 EHD / A 120 EHD		
MK 2534 K	01/1991 - 09/1996	A 135 APC	A 140 EHD / A 120 EHD		
MK 2534 L	12/1987 - 09/1996	A 135 APC	A 140 EHD / A 120 EHD		
MK 2534 S,2534 LS	12/1987 - 09/1996	A 135 APC	A 140 EHD / A 120 EHD		
MK 2534,2534 L	12/1987 - 09/1996	A 135 APC	A 140 EHD / A 120 EHD		

MARCHIO E MODELLO - MAKE AND MODEL MARQUE ET MODÈLE - MARKE UND MODELL MARCA Y MODELO - МАРКА И МОДЕЛЬ	Periodo Period	powerCUBE		energyCUBE	
		APC	EHD	APC	RST
MERCEDES-BENZ cont.					
MK 3231 L	12/1987 - 09/1996	A 135 APC	A 140 EHD / A 120 EHD		
NG 1013	02/1976 - 12/1984	A 135 APC	A 140 EHD / A 120 EHD		
NG 1013 A	02/1976 - 12/1986	A 135 APC	A 140 EHD / A 120 EHD		
NG 1013 AK	02/1976 - 12/1984	A 135 APC	A 140 EHD / A 120 EHD		
NG 1013 K	02/1976 - 12/1984	A 135 APC	A 140 EHD / A 120 EHD		
NG 1013 KO	02/1976 - 12/1984	A 135 APC	A 140 EHD / A 120 EHD		
NG 1013 S	02/1976 - 12/1984	A 135 APC	A 140 EHD / A 120 EHD		
NG 1017	11/1975 - 02/1991	A 135 APC	A 140 EHD / A 120 EHD		
NG 1017 A	11/1975 - 02/1991	A 135 APC	A 140 EHD / A 120 EHD		
NG 1017 AF	11/1975 - 09/1985	A 135 APC	A 140 EHD / A 120 EHD		
NG 1017 AK	02/1976 - 12/1984	A 135 APC	A 140 EHD / A 120 EHD		
NG 1017 AS	04/1977 - 09/1985	A 135 APC	A 140 EHD / A 120 EHD		
NG 1017 K	02/1976 - 12/1984	A 135 APC	A 140 EHD / A 120 EHD		
NG 1017 KO,1017 F	08/1973 - 09/1996	A 135 APC	A 140 EHD / A 120 EHD		
NG 1017 S,1017 LS	08/1973 - 09/1996	A 135 APC	A 140 EHD / A 120 EHD		
NG 1019 AF	01/1979 - 12/1982	A 135 APC	A 140 EHD / A 120 EHD		
NG 1019 F	01/1979 - 12/1982	A 135 APC	A 140 EHD / A 120 EHD		
NG 1213	09/1975 - 05/1986	A 135 APC	A 140 EHD / A 120 EHD		
NG 1213 A	09/1975 - 05/1986	A 135 APC	A 140 EHD / A 120 EHD		
NG 1213 AK	09/1975 - 05/1986	A 135 APC	A 140 EHD / A 120 EHD		
NG 1213 AKO	09/1975 - 05/1986	A 135 APC	A 140 EHD / A 120 EHD		
NG 1213 AS	09/1975 - 05/1986	A 135 APC	A 140 EHD / A 120 EHD		
NG 1213 K	09/1975 - 05/1986	A 135 APC	A 140 EHD / A 120 EHD		
NG 1213 KO	09/1975 - 05/1986	A 135 APC	A 140 EHD / A 120 EHD		
NG 1213 S	09/1975 - 05/1986	A 135 APC	A 140 EHD / A 120 EHD		
NG 1217 A	09/1975 - 09/1985	A 135 APC	A 140 EHD / A 120 EHD		
NG 1217 AK	09/1975 - 09/1985	A 135 APC	A 140 EHD / A 120 EHD		
NG 1217 AS	09/1975 - 09/1985	A 135 APC	A 140 EHD / A 120 EHD		
NG 1217 CA	05/1982 - 10/1990	A 135 APC	A 140 EHD / A 120 EHD		
NG 1217 K	09/1975 - 12/1984	A 135 APC	A 140 EHD / A 120 EHD		
NG 1217 KO	09/1975 - 09/1985	A 135 APC	A 140 EHD / A 120 EHD		
NG 1217 S,1217 LS	08/1973 - 09/1996	A 135 APC	A 140 EHD / A 120 EHD		
NG 1217,1217 L	08/1973 - 09/1996	A 135 APC	A 140 EHD / A 120 EHD		
NG 1219	09/1975 - 09/1984	A 135 APC	A 140 EHD / A 120 EHD		
NG 1219 A	09/1975 - 12/1982	A 135 APC	A 140 EHD / A 120 EHD		
NG 1219 AF	09/1975 - 09/1984	A 135 APC	A 140 EHD / A 120 EHD		
NG 1219 AK	09/1975 - 12/1984	A 135 APC	A 140 EHD / A 120 EHD		
NG 1219 F	09/1975 - 09/1984	A 135 APC	A 140 EHD / A 120 EHD		
NG 1219 K	09/1975 - 09/1984	A 135 APC	A 140 EHD / A 120 EHD		
NG 1219 S	09/1975 - 09/1984	A 135 APC	A 140 EHD / A 120 EHD		
NG 1222	07/1982 - 02/1990	A 135 APC	A 140 EHD / A 120 EHD		
NG 1222 A	05/1982 - 10/1990	A 135 APC	A 140 EHD / A 120 EHD		
NG 1222 AF	05/1982 - 12/1991	A 135 APC	A 140 EHD / A 120 EHD		
NG 1222 F	05/1982 - 12/1991	A 135 APC	A 140 EHD / A 120 EHD		
NG 1222 S	07/1982 - 02/1990	A 135 APC	A 140 EHD / A 120 EHD		

MARCHIO E MODELLO - MAKE AND MODEL MARQUE ET MODÈLE - MARKE UND MODELL MARCA Y MODELO - МАРКА И МОДЕЛЬ	Periodo <i>Period</i>	powerCUBE		energyCUBE	
		APC	EHD	APC	RST
MERCEDES-BENZ					
cont.					
NG 1225 AF	05/1982 - 12/1991	A 135 APC	A 140 EHD / A 120 EHD		
NG 1228 AF	05/1982 - 12/1991	A 135 APC	A 140 EHD / A 120 EHD		
NG 1413	09/1975 - 12/1984	A 135 APC	A 140 EHD / A 120 EHD		
NG 1413 A	09/1975 - 12/1984	A 135 APC	A 140 EHD / A 120 EHD		
NG 1413 AK	09/1975 - 12/1984	A 135 APC	A 140 EHD / A 120 EHD		
NG 1413 AKO	09/1975 - 12/1984	A 135 APC	A 140 EHD / A 120 EHD		
NG 1413 K	09/1975 - 12/1984	A 135 APC	A 140 EHD / A 120 EHD		
NG 1413 KO	09/1975 - 12/1984	A 135 APC	A 140 EHD / A 120 EHD		
NG 1414	04/1984 - 03/1991	A 135 APC	A 140 EHD / A 120 EHD		
NG 1414 K	04/1984 - 03/1991	A 135 APC	A 140 EHD / A 120 EHD		
NG 1417	05/1975 - 12/1984	A 135 APC	A 140 EHD / A 120 EHD		
NG 1417 A	05/1975 - 12/1984	A 135 APC	A 140 EHD / A 120 EHD		
NG 1417 AK	05/1975 - 12/1984	A 135 APC	A 140 EHD / A 120 EHD		
NG 1417 AKO	05/1975 - 12/1984	A 135 APC	A 140 EHD / A 120 EHD		
NG 1417 C	04/1984 - 03/1991	A 135 APC	A 140 EHD / A 120 EHD		
NG 1417 CA	04/1984 - 03/1991	A 135 APC	A 140 EHD / A 120 EHD		
NG 1417 CAK	04/1984 - 03/1991	A 135 APC	A 140 EHD / A 120 EHD		
NG 1417 CK	04/1984 - 03/1991	A 135 APC	A 140 EHD / A 120 EHD		
NG 1417 K	05/1975 - 12/1984	A 135 APC	A 140 EHD / A 120 EHD		
NG 1417 KO	05/1975 - 12/1984	A 135 APC	A 140 EHD / A 120 EHD		
NG 1419 AK	05/1975 - 12/1984	A 135 APC	A 140 EHD / A 120 EHD		
NG 1419 AS	05/1975 - 12/1982	A 135 APC	A 140 EHD / A 120 EHD		
NG 1419 C,1419 CL	08/1973 - 09/1996	A 135 APC	A 140 EHD / A 120 EHD		
NG 1419 F	05/1975 - 12/1982	A 135 APC	A 140 EHD / A 120 EHD		
NG 1419 K	05/1975 - 12/1982	A 135 APC	A 140 EHD / A 120 EHD		
NG 1419 S,1419 LS	08/1973 - 09/1996	A 135 APC	A 140 EHD / A 120 EHD		
NG 1419,1419 L	08/1973 - 09/1996	A 135 APC	A 140 EHD / A 120 EHD		
NG 1420 LS	07/1985 - 03/1991	A 135 APC	A 140 EHD / A 120 EHD		
NG 1420,1420 L	08/1973 - 09/1996	A 135 APC	A 140 EHD / A 120 EHD		
NG 1422 F	05/1982 - 10/1990	A 135 APC	A 140 EHD / A 120 EHD		
NG 1422 S,1422 LS	08/1973 - 09/1996	A 135 APC	A 140 EHD / A 120 EHD		
NG 1422,1422 L	08/1973 - 09/1996	A 135 APC	A 140 EHD / A 120 EHD		
NG 1424 F	07/1975 - 01/1987	A 135 APC	A 140 EHD / A 120 EHD		
NG 1424 K	07/1975 - 01/1987	A 135 APC	A 140 EHD / A 120 EHD		
NG 1424 S,1424 LS	08/1973 - 09/1996	A 135 APC	A 140 EHD / A 120 EHD		
NG 1424,1424 L	08/1973 - 09/1996	A 135 APC	A 140 EHD / A 120 EHD		
NG 1425 AF	08/1973 - 09/1996	A 135 APC	A 140 EHD / A 120 EHD		
NG 1425 S,1425 LS	08/1973 - 09/1996	A 135 APC	A 140 EHD / A 120 EHD		
NG 1428 F	05/1982 - 12/1991	A 135 APC	A 140 EHD / A 120 EHD		
NG 1428AF	08/1973 - 09/1996	A 135 APC	A 140 EHD / A 120 EHD		
NG 1429 AF	08/1973 - 09/1996	A 135 APC	A 140 EHD / A 120 EHD		
NG 1613 K	01/1975 - 12/1984	A 135 APC	A 140 EHD / A 120 EHD		
NG 1613 KO	01/1975 - 12/1984	A 135 APC	A 140 EHD / A 120 EHD		
NG 1613,1613 L	08/1973 - 09/1996	A 135 APC	A 140 EHD / A 120 EHD		
NG 1614	04/1984 - 03/1991	A 135 APC	A 140 EHD / A 120 EHD		

MARCHIO E MODELLO - MAKE AND MODEL MARQUE ET MODÈLE - MARKE UND MODELL MARCA Y MODELO - МАРКА И МОДЕЛЬ	Periodo Period	powerCUBE		energyCUBE	
		APC	EHD	APC	RST
MERCEDES-BENZ cont.					
NG 1614 K	04/1984 - 03/1991	A 135 APC	A 140 EHD / A 120 EHD		
NG 1617 AK	01/1975 - 07/1985	A 135 APC	A 140 EHD / A 120 EHD		
NG 1617 C,1617 CL	08/1973 - 09/1996	A 135 APC	A 140 EHD / A 120 EHD		
NG 1617 CAK	04/1984 - 03/1991	A 135 APC	A 140 EHD / A 120 EHD		
NG 1617 CK	04/1984 - 03/1991	A 135 APC	A 140 EHD / A 120 EHD		
NG 1617 CS	04/1984 - 03/1991	A 135 APC	A 140 EHD / A 120 EHD		
NG 1617 K	01/1975 - 07/1985	A 135 APC	A 140 EHD / A 120 EHD		
NG 1617 KO	01/1975 - 07/1985	A 135 APC	A 140 EHD / A 120 EHD		
NG 1617 S	01/1975 - 07/1985	A 135 APC	A 140 EHD / A 120 EHD		
NG 1617,1617 L	08/1973 - 09/1996	A 135 APC	A 140 EHD / A 120 EHD		
NG 1619 AK	11/1974 - 12/1982	A 135 APC	A 140 EHD / A 120 EHD		
NG 1619 C,1619 CL	08/1973 - 09/1996	A 135 APC	A 140 EHD / A 120 EHD		
NG 1619 K	11/1974 - 12/1982	A 135 APC	A 140 EHD / A 120 EHD		
NG 1619 KO	11/1974 - 01/1987	A 135 APC	A 140 EHD / A 120 EHD		
NG 1619 S	11/1974 - 12/1984	A 135 APC	A 140 EHD / A 120 EHD		
NG 1619,1619 L	08/1973 - 09/1996	A 135 APC	A 140 EHD / A 120 EHD		
NG 1620,1620 L	08/1973 - 09/1996	A 135 APC	A 140 EHD / A 120 EHD		
NG 1622 AK	05/1982 - 10/1989	A 135 APC	A 140 EHD / A 120 EHD		
NG 1622 K	05/1982 - 10/1989	A 135 APC	A 140 EHD / A 120 EHD		
NG 1622 S	05/1982 - 03/1991	A 135 APC	A 140 EHD / A 120 EHD		
NG 1622,1622 L	08/1973 - 09/1996	A 135 APC	A 140 EHD / A 120 EHD		
NG 1624 K	07/1975 - 08/1982	A 135 APC	A 140 EHD / A 120 EHD		
NG 1624 S,1624 LS	08/1973 - 09/1996	A 135 APC	A 140 EHD / A 120 EHD		
NG 1624,1624 L	08/1973 - 09/1996	A 135 APC	A 140 EHD / A 120 EHD		
NG 1625 AK	10/1980 - 11/1989	A 135 APC	A 140 EHD / A 120 EHD		
NG 1625 K	05/1980 - 11/1989	A 135 APC	A 140 EHD / A 120 EHD		
NG 1625 S,1625 LS	08/1973 - 09/1996	A 135 APC	A 140 EHD / A 120 EHD		
NG 1625,1625 L	08/1973 - 09/1996	A 135 APC	A 140 EHD / A 120 EHD		
NG 1626 AK	08/1973 - 12/1980	A 135 APC	A 140 EHD / A 120 EHD		
NG 1626 AS	05/1974 - 12/1980	A 135 APC	A 140 EHD / A 120 EHD		
NG 1626 K	08/1973 - 12/1980	A 135 APC	A 140 EHD / A 120 EHD		
NG 1626 S,1626 LS	08/1973 - 09/1996	A 135 APC	A 140 EHD / A 120 EHD		
NG 1626,1626 L	08/1973 - 09/1996	A 135 APC	A 140 EHD / A 120 EHD		
NG 1628 A	01/1980 - 05/1989	A 135 APC	A 140 EHD / A 120 EHD		
NG 1628 S,1628 LS	08/1973 - 09/1996	A 135 APC	A 140 EHD / A 120 EHD		
NG 1628,1628 L	08/1973 - 09/1996	A 135 APC	A 140 EHD / A 120 EHD		
NG 1632 AK	08/1973 - 08/1982	A 135 APC	A 140 EHD / A 120 EHD		
NG 1632 AS	05/1974 - 09/1983	A 135 APC	A 140 EHD / A 120 EHD		
NG 1632 K	08/1973 - 08/1982	A 135 APC	A 140 EHD / A 120 EHD		
NG 1632 S,1632 LS	08/1973 - 09/1996	A 135 APC	A 140 EHD / A 120 EHD		
NG 1632,1632 L	08/1973 - 09/1996	A 135 APC	A 140 EHD / A 120 EHD		
NG 1633 S,1633 LS	08/1973 - 09/1996	A 135 APC	A 140 EHD / A 120 EHD		
NG 1633,1633 L	08/1973 - 09/1996	A 135 APC	A 140 EHD / A 120 EHD		
NG 1635 K	02/1986 - 07/1989	A 135 APC	A 140 EHD / A 120 EHD		
NG 1635 S,1635 LS	08/1973 - 09/1996	A 135 APC	A 140 EHD / A 120 EHD		

MARCHIO E MODELLO - MAKE AND MODEL MARQUE ET MODÈLE - MARKE UND MODELL MARCA Y MODELO - МАРКА И МОДЕЛЬ	Periodo Period	powerCUBE		energyCUBE	
		APC	EHD	APC	RST
MERCEDES-BENZ cont.					
NG 1635,1635 L	08/1973 - 09/1996	A 135 APC	A 140 EHD / A 120 EHD		
NG 1636 S,1636 LS	08/1973 - 09/1996	A 135 APC	A 140 EHD / A 120 EHD		
NG 1636,1636 L	08/1973 - 09/1996	A 135 APC	A 140 EHD / A 120 EHD		
NG 1638	11/1980 - 12/1986	A 135 APC	A 140 EHD / A 120 EHD		
NG 1638 S,1638 LS	08/1973 - 09/1996	A 135 APC	A 140 EHD / A 120 EHD		
NG 1644	06/1986 - 08/1989	A 135 APC	A 140 EHD / A 120 EHD		
NG 1644 S,1644 LS	08/1973 - 09/1996	A 135 APC	A 140 EHD / A 120 EHD		
NG 1719	09/1973 - 08/1982	A 135 APC	A 140 EHD / A 120 EHD		
NG 1719 AK	09/1973 - 08/1982	A 135 APC	A 140 EHD / A 120 EHD		
NG 1719 K	09/1973 - 08/1982	A 135 APC	A 140 EHD / A 120 EHD		
NG 1719 S	09/1973 - 08/1982	A 135 APC	A 140 EHD / A 120 EHD		
NG 1919	05/1974 - 08/1982	A 135 APC	A 140 EHD / A 120 EHD		
NG 1919 AK	05/1974 - 08/1982	A 135 APC	A 140 EHD / A 120 EHD		
NG 1919 K	05/1974 - 08/1982	A 135 APC	A 140 EHD / A 120 EHD		
NG 1919 S	05/1974 - 08/1982	A 135 APC	A 140 EHD / A 120 EHD		
NG 1922	10/1981 - 10/1990	A 135 APC	A 140 EHD / A 120 EHD		
NG 1922 AK	10/1981 - 03/1991	A 135 APC	A 140 EHD / A 120 EHD		
NG 1922 K	10/1981 - 03/1991	A 135 APC	A 140 EHD / A 120 EHD		
NG 1922 S	10/1981 - 03/1991	A 135 APC	A 140 EHD / A 120 EHD		
NG 1926	05/1974 - 12/1980	A 135 APC	A 140 EHD / A 120 EHD		
NG 1926 A	05/1974 - 12/1980	A 135 APC	A 140 EHD / A 120 EHD		
NG 1926 AK	08/1973 - 12/1980	A 135 APC	A 140 EHD / A 120 EHD		
NG 1926 AS	05/1974 - 12/1980	A 135 APC	A 140 EHD / A 120 EHD		
NG 1926 K	08/1973 - 12/1980	A 135 APC	A 140 EHD / A 120 EHD		
NG 1926 S,1926 LS	08/1973 - 09/1996	A 135 APC	A 140 EHD / A 120 EHD		
NG 1928 A	01/1980 - 03/1991	A 135 APC	A 140 EHD / A 120 EHD		
NG 1928 AK	01/1980 - 03/1991	A 135 APC	A 140 EHD / A 120 EHD		
NG 1928 AS	01/1980 - 03/1991	A 135 APC	A 140 EHD / A 120 EHD		
NG 1928 K	01/1980 - 03/1991	A 135 APC	A 140 EHD / A 120 EHD		
NG 1928 S,1928 LS	08/1973 - 09/1996	A 135 APC	A 140 EHD / A 120 EHD		
NG 1928,1928 L	08/1973 - 09/1996	A 135 APC	A 140 EHD / A 120 EHD		
NG 1932	05/1974 - 03/1983	A 135 APC	A 140 EHD / A 120 EHD		
NG 1932 A	05/1974 - 03/1983	A 135 APC	A 140 EHD / A 120 EHD		
NG 1932 AK	08/1973 - 09/1983	A 135 APC	A 140 EHD / A 120 EHD		
NG 1932 AS	05/1974 - 12/1982	A 135 APC	A 140 EHD / A 120 EHD		
NG 1932 K	08/1973 - 08/1982	A 135 APC	A 140 EHD / A 120 EHD		
NG 1932 S,1932 LS	08/1973 - 09/1996	A 135 APC	A 140 EHD / A 120 EHD		
NG 1933	11/1980 - 03/1991	A 135 APC	A 140 EHD / A 120 EHD		
NG 1933 S,1933 LS	08/1973 - 09/1996	A 135 APC	A 140 EHD / A 120 EHD		
NG 1935	02/1986 - 09/1989	A 135 APC	A 140 EHD / A 120 EHD		
NG 1935 AK	09/1987 - 03/1991	A 135 APC	A 140 EHD / A 120 EHD		
NG 1935 AS	09/1987 - 03/1991	A 135 APC	A 140 EHD / A 120 EHD		
NG 1935 S,1935 LS	08/1973 - 09/1996	A 135 APC	A 140 EHD / A 120 EHD		
NG 1936	10/1981 - 03/1991	A 135 APC	A 140 EHD / A 120 EHD		
NG 1936 AK	10/1981 - 03/1991	A 135 APC	A 140 EHD / A 120 EHD		

MARCHIO E MODELLO - MAKE AND MODEL MARQUE ET MODÈLE - MARKE UND MODELL MARCA Y MODELO - МАРКА И МОДЕЛЬ	Periodo Period	powerCUBE		energyCUBE	
		APC	EHD	APC	RST
MERCEDES-BENZ cont.					
NG 1936 AS	10/1981 - 03/1991	A 135 APC	A 140 EHD / A 120 EHD		
NG 1936 K	10/1981 - 03/1991	A 135 APC	A 140 EHD / A 120 EHD		
NG 1936 S,1936 LS	08/1973 - 09/1996	A 135 APC	A 140 EHD / A 120 EHD		
NG 1938	11/1980 - 06/1990	A 135 APC	A 140 EHD / A 120 EHD		
NG 1938 S,1938 LS	08/1973 - 09/1996	A 135 APC	A 140 EHD / A 120 EHD		
NG 1944	10/1985 - 12/1989	A 135 APC	A 140 EHD / A 120 EHD		
NG 1944 S,1944 LS	08/1973 - 09/1996	A 135 APC	A 140 EHD / A 120 EHD		
NG 2025 S	08/1983 - 03/1991	A 135 APC	A 140 EHD / A 120 EHD		
NG 2026 S	10/1976 - 10/1980	A 135 APC	A 140 EHD / A 120 EHD		
NG 2028 A	01/1980 - 06/1989	A 135 APC	A 140 EHD / A 120 EHD		
NG 2028 LS	01/1980 - 06/1989	A 135 APC	A 140 EHD / A 120 EHD		
NG 2032 S	08/1975 - 09/1983	A 135 APC	A 140 EHD / A 120 EHD		
NG 2033 LS	12/1981 - 05/1987	A 135 APC	A 140 EHD / A 120 EHD		
NG 2035 S,2035 LS	08/1973 - 09/1996	A 135 APC	A 140 EHD / A 120 EHD		
NG 2036 LS	03/1984 - 03/1991	A 135 APC	A 140 EHD / A 120 EHD		
NG 2219	06/1976 - 01/1987	A 135 APC	A 140 EHD / A 120 EHD		
NG 2219 C,2219 CL	08/1973 - 09/1996	A 135 APC	A 140 EHD / A 120 EHD		
NG 2219 K	06/1976 - 01/1987	A 135 APC	A 140 EHD / A 120 EHD		
NG 2219 KO	06/1976 - 01/1987	A 135 APC	A 140 EHD / A 120 EHD		
NG 2219,2219 L	08/1973 - 09/1996	A 135 APC	A 140 EHD / A 120 EHD		
NG 2220,2220 L	08/1973 - 09/1996	A 135 APC	A 140 EHD / A 120 EHD		
NG 2222	05/1982 - 03/1991	A 135 APC	A 140 EHD / A 120 EHD		
NG 2222 B	05/1982 - 03/1991	A 135 APC	A 140 EHD / A 120 EHD		
NG 2222 K	05/1982 - 03/1991	A 135 APC	A 140 EHD / A 120 EHD		
NG 2222 K	05/1982 - 10/1989	A 135 APC	A 140 EHD / A 120 EHD		
NG 2222 L	08/1973 - 09/1996	A 135 APC	A 140 EHD / A 120 EHD		
NG 2222,2222 L	08/1973 - 09/1996	A 135 APC	A 140 EHD / A 120 EHD		
NG 2224	04/1976 - 12/1982	A 135 APC	A 140 EHD / A 120 EHD		
NG 2224 B	05/1975 - 03/1984	A 135 APC	A 140 EHD / A 120 EHD		
NG 2224 K	04/1976 - 12/1982	A 135 APC	A 140 EHD / A 120 EHD		
NG 2224 S	07/1976 - 12/1982	A 135 APC	A 140 EHD / A 120 EHD		
NG 2225	04/1985 - 03/1991	A 135 APC	A 140 EHD / A 120 EHD		
NG 2225 B	08/1983 - 03/1991	A 135 APC	A 140 EHD / A 120 EHD		
NG 2225 L	08/1973 - 09/1996	A 135 APC	A 140 EHD / A 120 EHD		
NG 2226	09/1975 - 12/1980	A 135 APC	A 140 EHD / A 120 EHD		
NG 2226 S,2226 LS	08/1973 - 09/1996	A 135 APC	A 140 EHD / A 120 EHD		
NG 2226,2226 L	08/1973 - 09/1996	A 135 APC	A 140 EHD / A 120 EHD		
NG 2228	12/1979 - 03/1991	A 135 APC	A 140 EHD / A 120 EHD		
NG 2228 S	12/1979 - 03/1991	A 135 APC	A 140 EHD / A 120 EHD		
NG 2228,2228 L	08/1973 - 09/1996	A 135 APC	A 140 EHD / A 120 EHD		
NG 2232	05/1974 - 09/1983	A 135 APC	A 140 EHD / A 120 EHD		
NG 2232 S,2232 LS	08/1973 - 09/1996	A 135 APC	A 140 EHD / A 120 EHD		
NG 2232,2232 L	08/1973 - 09/1996	A 135 APC	A 140 EHD / A 120 EHD		
NG 2233	11/1980 - 05/1987	A 135 APC	A 140 EHD / A 120 EHD		
NG 2233 S	11/1980 - 05/1987	A 135 APC	A 140 EHD / A 120 EHD		

MARCHIO E MODELLO - MAKE AND MODEL MARQUE ET MODÈLE - MARKE UND MODELL MARCA Y MODELO - МАРКА И МОДЕЛЬ	Periodo Period	powerCUBE		energyCUBE	
		APC	EHD	APC	RST
MERCEDES-BENZ cont.					
NG 2233,2233 L	08/1973 - 09/1996	A 135 APC	A 140 EHD / A 120 EHD		
NG 2235 K	03/1986 - 07/1989	A 135 APC	A 140 EHD / A 120 EHD		
NG 2235 S, 2235 LS	08/1973 - 09/1996	A 135 APC	A 140 EHD / A 120 EHD		
NG 2235,2235 L	08/1973 - 09/1996	A 135 APC	A 140 EHD / A 120 EHD		
NG 2236	09/1982 - 03/1991	A 135 APC	A 140 EHD / A 120 EHD		
NG 2236 S	12/1984 - 03/1991	A 135 APC	A 140 EHD / A 120 EHD		
NG 2238 S	01/1981 - 12/1986	A 135 APC	A 140 EHD / A 120 EHD		
NG 2238,2238 L	08/1973 - 09/1996	A 135 APC	A 140 EHD / A 120 EHD		
NG 2244 S	10/1985 - 07/1989	A 135 APC	A 140 EHD / A 120 EHD		
NG 2244,2244 L	08/1973 - 09/1996	A 135 APC	A 140 EHD / A 120 EHD		
NG 2422	08/1973 - 09/1996	A 135 APC	A 140 EHD / A 120 EHD		
NG 2422	10/1981 - 10/1990	A 135 APC	A 140 EHD / A 120 EHD		
NG 2422 K	10/1981 - 03/1991	A 135 APC	A 140 EHD / A 120 EHD		
NG 2428	08/1973 - 09/1996	A 135 APC	A 140 EHD / A 120 EHD		
NG 2433	10/1980 - 09/1996	A 135 APC	A 140 EHD / A 120 EHD		
NG 2433	11/1980 - 03/1991	A 135 APC	A 140 EHD / A 120 EHD		
NG 2438	08/1973 - 09/1996	A 135 APC	A 140 EHD / A 120 EHD		
NG 2438 L	11/1980 - 06/1990	A 135 APC	A 140 EHD / A 120 EHD		
NG 2444 LS	08/1973 - 09/1996	A 135 APC	A 140 EHD / A 120 EHD		
NG 2528 A	01/1980 - 03/1991	A 135 APC	A 140 EHD / A 120 EHD		
NG 2528 AK	01/1980 - 03/1991	A 135 APC	A 140 EHD / A 120 EHD		
NG 2536 AK	10/1981 - 03/1991	A 135 APC	A 140 EHD / A 120 EHD		
NG 2626	06/1975 - 03/1981	A 135 APC	A 140 EHD / A 120 EHD		
NG 2626 A	06/1975 - 03/1981	A 135 APC	A 140 EHD / A 120 EHD		
NG 2626 AB	05/1974 - 12/1980	A 135 APC	A 140 EHD / A 120 EHD		
NG 2626 AK	08/1973 - 12/1981	A 135 APC	A 140 EHD / A 120 EHD		
NG 2626 AS	06/1975 - 03/1981	A 135 APC	A 140 EHD / A 120 EHD		
NG 2626 B	05/1974 - 12/1980	A 135 APC	A 140 EHD / A 120 EHD		
NG 2626 K	08/1973 - 03/1981	A 135 APC	A 140 EHD / A 120 EHD		
NG 2626 S	06/1975 - 03/1981	A 135 APC	A 140 EHD / A 120 EHD		
NG 2628	02/1980 - 03/1991	A 135 APC	A 140 EHD / A 120 EHD		
NG 2628 A	01/1990 - 03/1991	A 135 APC	A 140 EHD / A 120 EHD		
NG 2628 A	02/1980 - 03/1991	A 135 APC	A 140 EHD / A 120 EHD		
NG 2628 AK	02/1980 - 03/1991	A 135 APC	A 140 EHD / A 120 EHD		
NG 2628 AS	02/1980 - 03/1991	A 135 APC	A 140 EHD / A 120 EHD		
NG 2628 B	02/1980 - 08/1989	A 135 APC	A 140 EHD / A 120 EHD		
NG 2628 K	02/1980 - 03/1991	A 135 APC	A 140 EHD / A 120 EHD		
NG 2628 S	02/1980 - 03/1991	A 135 APC	A 140 EHD / A 120 EHD		
NG 2632	05/1974 - 09/1983	A 135 APC	A 140 EHD / A 120 EHD		
NG 2632 A	05/1974 - 09/1983	A 135 APC	A 140 EHD / A 120 EHD		
NG 2632 AK	08/1973 - 09/1983	A 135 APC	A 140 EHD / A 120 EHD		
NG 2632 AS	05/1974 - 09/1983	A 135 APC	A 140 EHD / A 120 EHD		
NG 2632 K	08/1973 - 09/1983	A 135 APC	A 140 EHD / A 120 EHD		
NG 2632 S	05/1974 - 09/1983	A 135 APC	A 140 EHD / A 120 EHD		
NG 2633	05/1982 - 05/1987	A 135 APC	A 140 EHD / A 120 EHD		

MARCHIO E MODELLO - MAKE AND MODEL MARQUE ET MODÈLE - MARKE UND MODELL MARCA Y MODELO - МАРКА И МОДЕЛЬ	Periodo Period	powerCUBE		energyCUBE	
		APC	EHD	APC	RST
MERCEDES-BENZ <i>cont.</i>					
NG 2633 S	05/1982 - 05/1987	A 135 APC	A 140 EHD / A 120 EHD		
NG 2635	04/1986 - 03/1991	A 135 APC	A 140 EHD / A 120 EHD		
NG 2635 A	09/1987 - 03/1991	A 135 APC	A 140 EHD / A 120 EHD		
NG 2635 AK	09/1987 - 03/1991	A 135 APC	A 140 EHD / A 120 EHD		
NG 2635 AS	09/1987 - 03/1991	A 135 APC	A 140 EHD / A 120 EHD		
NG 2635 S	04/1986 - 03/1991	A 135 APC	A 140 EHD / A 120 EHD		
NG 2636	11/1981 - 03/1991	A 135 APC	A 140 EHD / A 120 EHD		
NG 2636 A	11/1981 - 03/1991	A 135 APC	A 140 EHD / A 120 EHD		
NG 2636 AK	11/1981 - 03/1991	A 135 APC	A 140 EHD / A 120 EHD		
NG 2636 AS	11/1981 - 03/1991	A 135 APC	A 140 EHD / A 120 EHD		
NG 2636 K	11/1981 - 03/1991	A 135 APC	A 140 EHD / A 120 EHD		
NG 2636 S	11/1981 - 03/1991	A 135 APC	A 140 EHD / A 120 EHD		
NG 2638	01/1981 - 12/1986	A 135 APC	A 140 EHD / A 120 EHD		
NG 2638 S	01/1981 - 12/1986	A 135 APC	A 140 EHD / A 120 EHD		
NG 2644	08/1973 - 09/1996	A 135 APC	A 140 EHD / A 120 EHD		
NG 2644 S	10/1985 - 02/1990	A 135 APC	A 140 EHD / A 120 EHD		
NG 3025 B	08/1983 - 03/1991	A 135 APC	A 140 EHD / A 120 EHD		
NG 3025 B	12/1985 - 07/1987	A 135 APC	A 140 EHD / A 120 EHD		
NG 3025 K	04/1985 - 03/1991	A 135 APC	A 140 EHD / A 120 EHD		
NG 3025 K	12/1985 - 07/1987	A 135 APC	A 140 EHD / A 120 EHD		
NG 3028	02/1980 - 03/1991	A 135 APC	A 140 EHD / A 120 EHD		
NG 3028 B	12/1985 - 07/1987	A 135 APC	A 140 EHD / A 120 EHD		
NG 3028 K	12/1985 - 07/1987	A 135 APC	A 140 EHD / A 120 EHD		
NG 3033	05/1982 - 05/1987	A 135 APC	A 140 EHD / A 120 EHD		
NG 3036	11/1981 - 03/1991	A 135 APC	A 140 EHD / A 120 EHD		
NG 3038	01/1981 - 12/1986	A 135 APC	A 140 EHD / A 120 EHD		
NG 3228 B	07/1987 - 03/1991	A 135 APC	A 140 EHD / A 120 EHD		
NG 3228 K	07/1987 - 03/1991	A 135 APC	A 140 EHD / A 120 EHD		
NG 3235	07/1988 - 08/1994	A 135 APC	A 140 EHD / A 120 EHD		
NG 3250 A	09/1985 - 08/1994	A 135 APC	A 140 EHD / A 120 EHD		
NG 3250 AF	09/1985 - 08/1994	A 135 APC	A 140 EHD / A 120 EHD		
NG 3328	02/1980 - 03/1991	A 135 APC	A 140 EHD / A 120 EHD		
NG 3328 B	02/1980 - 03/1991	A 135 APC	A 140 EHD / A 120 EHD		
NG 3328 B	07/1982 - 07/1987	A 135 APC	A 140 EHD / A 120 EHD		
NG 3328 K	07/1982 - 07/1987	A 135 APC	A 140 EHD / A 120 EHD		
NG 3333	12/1982 - 11/1991	A 135 APC	A 140 EHD / A 120 EHD		
NG 3333 B	12/1982 - 11/1991	A 135 APC	A 140 EHD / A 120 EHD		
NG 3333 K	12/1982 - 11/1991	A 135 APC	A 140 EHD / A 120 EHD		
NG 3335	04/1986 - 03/1991	A 135 APC	A 140 EHD / A 120 EHD		
NG 3335 A	04/1986 - 03/1991	A 135 APC	A 140 EHD / A 120 EHD		
NG 3336	12/1982 - 11/1991	A 135 APC	A 140 EHD / A 120 EHD		
NG 3336 A	11/1981 - 03/1991	A 135 APC	A 140 EHD / A 120 EHD		
NG 3336 AK	09/1986 - 11/1991	A 135 APC	A 140 EHD / A 120 EHD		
NG 3336 K	12/1982 - 11/1991	A 135 APC	A 140 EHD / A 120 EHD		
NG 3336 S	12/1982 - 11/1991	A 135 APC	A 140 EHD / A 120 EHD		

MARCHIO E MODELLO - MAKE AND MODEL MARQUE ET MODÈLE - MARKE UND MODELL MARCA Y MODELO - МАРКА И МОДЕЛЬ	Periodo Period	powerCUBE		energyCUBE	
		APC	EHD	APC	RST
MERCEDES-BENZ cont.					
NG 3338	01/1981 - 12/1986	A 135 APC	A 140 EHD / A 120 EHD		
NG 3528	07/1982 - 07/1987	A 135 APC	A 140 EHD / A 120 EHD		
NG 3528 B	07/1987 - 09/1989	A 135 APC	A 140 EHD / A 120 EHD		
NG 3528 K	07/1982 - 07/1987	A 135 APC	A 140 EHD / A 120 EHD		
NG 3528 K	07/1987 - 09/1989	A 135 APC	A 140 EHD / A 120 EHD		
NG 3535 AK	09/1987 - 02/1990	A 135 APC	A 140 EHD / A 120 EHD		
NG 3535 K	09/1987 - 01/1989	A 135 APC	A 140 EHD / A 120 EHD		
NG 3544	08/1973 - 09/1996	A 135 APC	A 140 EHD / A 120 EHD		
NG 3544 S	08/1973 - 09/1996	A 135 APC	A 140 EHD / A 120 EHD		
NG 3836 AK	11/1981 - 03/1991	A 135 APC	A 140 EHD / A 120 EHD		
NG 3850 A	09/1985 - 08/1994	A 135 APC	A 140 EHD / A 120 EHD		
O 301 O 301	02/1986 - 05/1987	A 135 APC	A 140 EHD / A 120 EHD		
O 301 O 301	06/1986 - 05/1987	A 135 APC	A 140 EHD / A 120 EHD		
O 302 130PS	11/1964 - 11/1975	B 180 APC	B 180 EHD / B 160 EHD	B 185 APC	
O 302 O 302		B 180 APC		B 185 APC	
O 302 O 302	05/1969 - 12/1974	B 180 APC	B 180 EHD / B 160 EHD	B 185 APC	
O 303 O 303	01/1980 - 01/1989	B 180 APC	B 180 EHD	B 185 APC	
O 303 O 303	01/1980 - 09/1987	B 180 APC	B 180 EHD	B 185 APC	
O 303 O 303	01/1980 - 09/1992	B 180 APC	B 180 EHD	B 185 APC	
O 303 O 303	03/1975 - 06/1983	B 180 APC	B 180 EHD	B 185 APC	
O 303 O 303	07/1975 - 06/1983	B 180 APC	B 180 EHD	B 185 APC	
O 303 O 303	08/1980 - 09/1987	B 180 APC	B 180 EHD	B 185 APC	
O 303 O 303	09/1987 - 09/1992	B 180 APC	B 180 EHD	B 185 APC	
O 303 O 303	10/1974 - 06/1983	B 180 APC	B 180 EHD	B 185 APC	
O 303 O 303	11/1985 - 04/1989	B 180 APC	B 180 EHD	B 185 APC	
O 303 O 303	12/1987 - 09/1992	B 180 APC	B 180 EHD	B 185 APC	
O 303 O 303	12/1987 -	B 180 APC		B 185 APC	
O 304 0304		B 180 APC	B 180 EHD	B 185 APC	
O 304 0304	08/1992 -	B 180 APC	B 180 EHD	B 185 APC	
O 305 O 305 G	02/1978 - 05/1987	B 180 APC	B 180 EHD / B 160 EHD	B 185 APC	
O 305 O 305 G	02/1979 - 05/1987	B 180 APC	B 180 EHD / B 160 EHD	B 185 APC	
O 305 O 305 ST	01/1969 - 05/1973	B 180 APC	B 180 EHD / B 160 EHD	B 185 APC	
O 305 O 305 ST	01/1970 - 05/1973	B 180 APC	B 180 EHD / B 160 EHD	B 185 APC	
O 305 O 305 ST	02/1979 - 05/1987	B 180 APC	B 180 EHD / B 160 EHD	B 185 APC	
O 305 O 305 ST	04/1973 - 07/1977	B 180 APC	B 180 EHD / B 160 EHD	B 185 APC	
O 305 O 305 ST	11/1976 - 05/1987	B 180 APC	B 180 EHD / B 160 EHD	B 185 APC	
O 307 O 307	04/1973 - 07/1977	B 180 APC	B 180 EHD / B 160 EHD	B 185 APC	
O 307 O 307	11/1976 - 07/1987	B 180 APC	B 180 EHD / B 160 EHD	B 185 APC	
O 307 O 307	11/1976 - 08/1987	B 180 APC	B 180 EHD / B 160 EHD	B 185 APC	
O 317 O 317	01/1966 - 01/1976	B 180 APC	B 180 EHD / B 160 EHD	B 185 APC	
O 330 O 330	01/1990 -	CX 225 APC	CX 200 EHD	CX 220 APC	
O 340 O 340	01/1991 -	CX 225 APC	CX 200 EHD	CX 220 APC	
O 340 0340	01/1991 - 06/1995	CX 225 APC	CX 200 EHD	CX 220 APC	
O 340 Turismo	08/1992 - 08/1995	CX 225 APC	CX 200 EHD	CX 220 APC	
O 402 O 402	02/1986 - 12/1991	A 135 APC	A 140 EHD / A 120 EHD		

MARCHIO E MODELLO - MAKE AND MODEL MARQUE ET MODÈLE - MARKE UND MODELL MARCA Y MODELO - МАРКА И МОДЕЛЬ	Periodo Period	powerCUBE		energyCUBE	
		APC	EHD	APC	RST
MERCEDES-BENZ <i>cont.</i>					
O 403 O 403 RHD		CX 225 APC	CX 200 EHD	CX 220 APC	
O 403 O 403 RHD	09/2003 -	CX 225 APC	CX 200 EHD	CX 220 APC	
O 403 O 403 SHD		CX 225 APC	CX 200 EHD	CX 220 APC	
O 403 O 403 SHD	09/2003 -	CX 225 APC	CX 200 EHD	CX 220 APC	
O 404 O 404		B 180 APC	B 180 EHD	B 185 APC	
O 404 O 404	09/1991 - 01/1992	CX 225 APC	CX 200 EHD	CX 220 APC	
O 404 O 404	09/1991 - 10/1999	CX 225 APC	CX 200 EHD	CX 220 APC	
O 404 O 404	09/1994 - 10/1999	CX 225 APC	CX 200 EHD	CX 220 APC	
O 405 O 405 G,O 405 GN,O 405 GTD	09/1991 -	CX 225 APC	CX 200 EHD	CX 220 APC	
O 405 O 405 G,O 405 GN,O 405 GTD	11/1985 -	CX 225 APC	CX 200 EHD	CX 220 APC	
O 405 O 405 G,O 405 GTD	01/1986 -	CX 225 APC	CX 200 EHD	CX 220 APC	
O 405 O 405 GN	11/1985 -	B 180 APC	B 180 EHD	B 185 APC	
O 405 O 405 GT	09/1991 -	B 180 APC	B 180 EHD	B 185 APC	
O 405 O 405 GT	11/1991 -	B 180 APC	B 180 EHD	B 185 APC	
O 405 O 405 GTZ		B 180 APC	B 180 EHD	B 185 APC	
O 405 O 405 N O 405 NH	11/1985 -	B 180 APC	B 180 EHD	B 185 APC	
O 405 O 405 ST	11/1985 -	CX 225 APC	CX 200 EHD	CX 220 APC	
O 405 O 405 ST,O 405 N	11/1985 -	CX 225 APC	CX 200 EHD	CX 220 APC	
O 405 O 405 ST,O 405 N	11/1991 -	CX 225 APC	CX 200 EHD	CX 220 APC	
O 405 O 405 ST,O 405 N	12/1984 -	CX 225 APC	CX 200 EHD	CX 220 APC	
O 407 O 407	03/1987 - 11/2001	CX 225 APC	CX 200 EHD	CX 220 APC	
O 407 O 407	11/1991 - 11/2001	CX 225 APC	CX 200 EHD	CX 220 APC	
O 408 O 408	01/1991 - 12/1998	CX 225 APC	CX 200 EHD	CX 220 APC	
O 408 O 408	08/1992 - 12/1998	CX 225 APC	CX 200 EHD	CX 220 APC	
O 500 O 500 GL, GLE		CX 225 APC	CX 200 EHD	CX 220 APC	
O 500 O 500 M		CX 225 APC	CX 200 EHD	CX 220 APC	
O 500 O 500 R		CX 225 APC	CX 200 EHD	CX 220 APC	
O 500 O 500 RSD		CX 225 APC	CX 200 EHD	CX 220 APC	
O 500 O 500 U		CX 225 APC	CX 200 EHD	CX 220 APC	
OF Series 1113		A 135 APC	A 140 EHD		
OF Series 1117	01/1983 -	A 135 APC	A 140 EHD		
OF Series 1313, 1314	01/1983 -	A 135 APC	A 140 EHD		
OF Series 1317	01/1983 -	A 135 APC	A 140 EHD		
OF Series 1413	01/1983 -	A 135 APC	A 140 EHD		
OF Series 1417	01/1983 -	A 135 APC	A 140 EHD		
OF Series 1617	01/1983 -	A 135 APC	A 140 EHD		
OF Series 1621	01/1983 -	A 135 APC	A 140 EHD		
OF Series 8000	01/2001 -	A 135 APC	A 140 EHD		
OH Series 1113	01/1970 -	A 135 APC	A 140 EHD		
OH Series 1316		A 135 APC	A 140 EHD		
OH Series 1416	01/1970 -	A 135 APC	A 140 EHD		
OH Series 1417	01/1970 -	A 135 APC	A 140 EHD		
OH Series 1418	01/1970 -	A 135 APC	A 140 EHD		
OH Series 1418	01/2009 -	A 135 APC	A 140 EHD / A 120 EHD		
OH Series 1518	01/1970 -	A 135 APC	A 140 EHD		

MARCHIO E MODELLO - MAKE AND MODEL MARQUE ET MODÈLE - MARKE UND MODELL MARCA Y MODELO - МАРКА И МОДЕЛЬ	Periodo Period	powerCUBE		energyCUBE	
		APC	EHD	APC	RST
MERCEDES-BENZ cont.					
OH Series 1519		A 135 APC	A 140 EHD		
OH Series 1520	01/1970 -	A 135 APC	A 140 EHD		
OH Series 1521		A 135 APC	A 140 EHD / A 120 EHD		
OH Series 1525		A 135 APC	A 140 EHD		
OH Series 1526		A 135 APC	A 140 EHD		
OH Series 1618	01/1970 -	A 135 APC	A 140 EHD		
OH Series 1622, 1622L		A 135 APC	A 140 EHD		
OH Series 1622, 1622L	01/1970 -	A 135 APC	A 140 EHD		
OH Series 1625, 1625L		A 135 APC	A 140 EHD		
OH Series 1626, 1626L	01/1970 -	A 135 APC	A 140 EHD		
OH Series 1627L		A 135 APC	A 140 EHD		
OH Series 1628, 1628L		A 135 APC	A 140 EHD		
OH Series 1634L	01/1970 -	A 135 APC	A 140 EHD		
OH Series 1719LE	01/1970 -	A 135 APC	A 140 EHD		
OH Series 1829L	01/1970 -	A 135 APC	A 140 EHD		
SK 1728, 1729, 1729 L	07/1987 - 09/1996	A 135 APC	A 140 EHD / A 120 EHD		
SK 1729 AK	07/1988 - 09/1993	A 135 APC	A 140 EHD / A 120 EHD		
SK 1729 K	07/1988 - 08/1994	A 135 APC	A 140 EHD / A 120 EHD		
SK 1729 S,1729 LS	07/1987 - 09/1996	A 135 APC	A 140 EHD / A 120 EHD		
SK 1735 AK	08/1989 - 08/1994	A 135 APC	A 140 EHD / A 120 EHD		
SK 1735 K	07/1988 - 08/1994	A 135 APC	A 140 EHD / A 120 EHD		
SK 1735 L	07/1988 - 08/1994	A 135 APC	A 140 EHD / A 120 EHD		
SK 1735 S,1735 LS	07/1987 - 09/1996	A 135 APC	A 140 EHD / A 120 EHD		
SK 1735,1735 L	07/1987 - 09/1996	A 135 APC	A 140 EHD / A 120 EHD		
SK 1748 S,1748 LS	07/1987 - 09/1996	A 135 APC	A 140 EHD / A 120 EHD		
SK 1748,1748 L	07/1987 - 09/1996	A 135 APC	A 140 EHD / A 120 EHD		
SK 1831 AK	01/1994 - 09/1996	A 135 APC	A 140 EHD / A 120 EHD		
SK 1831 AK	05/1991 - 09/1996	A 135 APC	A 140 EHD / A 120 EHD		
SK 1831 K	07/1992 - 09/1996	A 135 APC	A 140 EHD / A 120 EHD		
SK 1831 S,1831 LS	07/1987 - 09/1996	A 135 APC	A 140 EHD / A 120 EHD		
SK 1831,1831 L	07/1987 - 09/1996	A 135 APC	A 140 EHD / A 120 EHD		
SK 1834 AK	07/1988 - 09/1993	A 135 APC	A 140 EHD / A 120 EHD		
SK 1834 S,1834 LS	07/1987 - 09/1996	A 135 APC	A 140 EHD / A 120 EHD		
SK 1834,1834 L	07/1987 - 09/1996	A 135 APC	A 140 EHD / A 120 EHD		
SK 1838 AK	01/1994 - 09/1996	A 135 APC	A 140 EHD / A 120 EHD		
SK 1838 AK	12/1992 - 09/1996	A 135 APC	A 140 EHD / A 120 EHD		
SK 1838 K	06/1995 - 09/1996	A 135 APC	A 140 EHD / A 120 EHD		
SK 1838 K	12/1990 - 09/1996	A 135 APC	A 140 EHD / A 120 EHD		
SK 1838 S,1838 LS	07/1987 - 09/1996	A 135 APC	A 140 EHD / A 120 EHD		
SK 1838,1838 L	07/1987 - 09/1996	A 135 APC	A 140 EHD / A 120 EHD		
SK 1840 LS	07/1991 - 07/1992	A 135 APC	A 140 EHD / A 120 EHD		
SK 1844 S,1844 LS	07/1987 - 09/1996	A 135 APC	A 140 EHD / A 120 EHD		
SK 1844,1844 L	07/1987 - 09/1996	A 135 APC	A 140 EHD / A 120 EHD		
SK 1850 K	07/1988 - 08/1994	A 135 APC	A 140 EHD / A 120 EHD		
SK 1850 LAS	07/1987 - 09/1996	A 135 APC	A 140 EHD / A 120 EHD		

MARCHIO E MODELLO - MAKE AND MODEL MARQUE ET MODÈLE - MARKE UND MODELL MARCA Y MODELO - МАРКА И МОДЕЛЬ	Periodo Period	powerCUBE		energyCUBE	
		APC	EHD	APC	RST
MERCEDES-BENZ cont.					
SK 1850 S,1850 LS	07/1987 - 09/1996	A 135 APC	A 140 EHD / A 120 EHD		
SK 1850,1850 L	07/1987 - 09/1996	A 135 APC	A 140 EHD / A 120 EHD		
SK 1853 AK	01/1996 - 09/1996	A 135 APC	A 140 EHD / A 120 EHD		
SK 1853 S,1853 LS	07/1987 - 09/1996	A 135 APC	A 140 EHD / A 120 EHD		
SK 1853,1853 L	07/1987 - 09/1996	A 135 APC	A 140 EHD / A 120 EHD		
SK 1922	05/1989 - 08/1994	A 135 APC	A 140 EHD / A 120 EHD		
SK 1922 AK	08/1989 - 08/1994	A 135 APC	A 140 EHD / A 120 EHD		
SK 1922 K	05/1989 - 08/1994	A 135 APC	A 140 EHD / A 120 EHD		
SK 1922 S	05/1989 - 08/1994	A 135 APC	A 140 EHD / A 120 EHD		
SK 1929 A	07/1988 - 08/1994	A 135 APC	A 140 EHD / A 120 EHD		
SK 1929 A	07/1988 - 09/1993	A 135 APC	A 140 EHD / A 120 EHD		
SK 1929 AK	07/1988 - 08/1994	A 135 APC	A 140 EHD / A 120 EHD		
SK 1929 AS	07/1988 - 08/1994	A 135 APC	A 140 EHD / A 120 EHD		
SK 1929 K	07/1988 - 08/1994	A 135 APC	A 140 EHD / A 120 EHD		
SK 1929 S	07/1988 - 08/1994	A 135 APC	A 140 EHD / A 120 EHD		
SK 1929,1929 L	07/1987 - 09/1996	A 135 APC	A 140 EHD / A 120 EHD		
SK 1935	05/1989 - 08/1994	A 135 APC	A 140 EHD / A 120 EHD		
SK 1935 AK	05/1989 - 08/1994	A 135 APC	A 140 EHD / A 120 EHD		
SK 1935 AS	05/1989 - 08/1994	A 135 APC	A 140 EHD / A 120 EHD		
SK 1935 K	05/1989 - 08/1994	A 135 APC	A 140 EHD / A 120 EHD		
SK 1935 S	05/1989 - 08/1994	A 135 APC	A 140 EHD / A 120 EHD		
SK 1945 AK	07/1988 - 08/1994	A 135 APC	A 140 EHD / A 120 EHD		
SK 1948	09/1988 - 07/1992	A 135 APC	A 140 EHD / A 120 EHD		
SK 2024	01/1994 - 09/1996	A 135 APC	A 140 EHD / A 120 EHD		
SK 2024	02/1993 - 09/1996	A 135 APC	A 140 EHD / A 120 EHD		
SK 2024 AK	01/1994 - 09/1996	A 135 APC	A 140 EHD / A 120 EHD		
SK 2024 AK	02/1993 - 09/1996	A 135 APC	A 140 EHD / A 120 EHD		
SK 2024 K	01/1994 - 09/1996	A 135 APC	A 140 EHD / A 120 EHD		
SK 2024 K	02/1993 - 09/1996	A 135 APC	A 140 EHD / A 120 EHD		
SK 2027 AK	02/1993 - 09/1996	A 135 APC	A 140 EHD / A 120 EHD		
SK 2031	03/1992 - 09/1996	A 135 APC	A 140 EHD / A 120 EHD		
SK 2031 A	01/1994 - 09/1996	A 135 APC	A 140 EHD / A 120 EHD		
SK 2031 A	03/1992 - 09/1996	A 135 APC	A 140 EHD / A 120 EHD		
SK 2031 AS	03/1992 - 09/1996	A 135 APC	A 140 EHD / A 120 EHD		
SK 2031 K	03/1992 - 09/1996	A 135 APC	A 140 EHD / A 120 EHD		
SK 2031 S	03/1992 - 09/1996	A 135 APC	A 140 EHD / A 120 EHD		
SK 2038	11/1991 - 09/1996	A 135 APC	A 140 EHD / A 120 EHD		
SK 2038	12/1992 -	A 135 APC	A 140 EHD / A 120 EHD		
SK 2038 AS	01/1994 - 09/1996	A 135 APC	A 140 EHD / A 120 EHD		
SK 2038 AS	12/1992 - 09/1996	A 135 APC	A 140 EHD / A 120 EHD		
SK 2038 S	11/1991 - 09/1996	A 135 APC	A 140 EHD / A 120 EHD		
SK 2044	01/1992 - 09/1996	A 135 APC	A 140 EHD / A 120 EHD		
SK 2044 AS	01/1994 - 09/1996	A 135 APC	A 140 EHD / A 120 EHD		
SK 2044 S	01/1992 - 09/1996	A 135 APC	A 140 EHD / A 120 EHD		
SK 2050	01/1991 - 09/1996	A 135 APC	A 140 EHD / A 120 EHD		

MARCHIO E MODELLO - MAKE AND MODEL MARQUE ET MODÈLE - MARKE UND MODELL MARCA Y MODELO - МАРКА И МОДЕЛЬ	Periodo Period	powerCUBE		energyCUBE	
		APC	EHD	APC	RST
MERCEDES-BENZ cont.					
SK 2050 S	01/1991 - 09/1996	A 135 APC	A 140 EHD / A 120 EHD		
SK 2055 AF	01/1992 - 09/1996	A 135 APC	A 140 EHD / A 120 EHD		
SK 2422 L	07/1987 - 09/1996	A 135 APC	A 140 EHD / A 120 EHD		
SK 2429	07/1987 - 09/1996	A 135 APC	A 140 EHD / A 120 EHD		
SK 2429	07/1988 - 08/1994	A 135 APC	A 140 EHD / A 120 EHD		
SK 2429 K	07/1988 - 08/1994	A 135 APC	A 140 EHD / A 120 EHD		
SK 2429 S	07/1988 - 08/1994	A 135 APC	A 140 EHD / A 120 EHD		
SK 2429 S,2429 LS	07/1987 - 09/1996	A 135 APC	A 140 EHD / A 120 EHD		
SK 2429, 2429 L	07/1987 - 09/1996	A 135 APC	A 140 EHD / A 120 EHD		
SK 2429,2429 L	07/1987 - 09/1996	A 135 APC	A 140 EHD / A 120 EHD		
SK 2434 L	07/1987 - 09/1996	A 135 APC	A 140 EHD / A 120 EHD		
SK 2435	07/1987 - 09/1996	A 135 APC	A 140 EHD / A 120 EHD		
SK 2435	07/1988 - 08/1994	A 135 APC	A 140 EHD / A 120 EHD		
SK 2435 K	07/1988 - 08/1994	A 135 APC	A 140 EHD / A 120 EHD		
SK 2435 LS	07/1987 - 09/1996	A 135 APC	A 140 EHD / A 120 EHD		
SK 2435 S	07/1988 - 08/1994	A 135 APC	A 140 EHD / A 120 EHD		
SK 2435 S,2435 LS	07/1987 - 09/1996	A 135 APC	A 140 EHD / A 120 EHD		
SK 2435,2435 L	07/1987 - 09/1996	A 135 APC	A 140 EHD / A 120 EHD		
SK 2448	07/1988 - 07/1992	A 135 APC	A 140 EHD / A 120 EHD		
SK 2448 LS	07/1988 - 07/1992	A 135 APC	A 140 EHD / A 120 EHD		
SK 2448 S	07/1988 - 07/1992	A 135 APC	A 140 EHD / A 120 EHD		
SK 2448,2448 L	07/1987 - 09/1996	A 135 APC	A 140 EHD / A 120 EHD		
SK 2531	05/1991 - 09/1996	A 135 APC	A 140 EHD / A 120 EHD		
SK 2531, 2531 L	07/1987 - 09/1996	A 135 APC	A 140 EHD / A 120 EHD		
SK 2534, 2534 L	07/1987 - 09/1996	A 135 APC	A 140 EHD / A 120 EHD		
SK 2538	01/1994 - 09/1996	A 135 APC	A 140 EHD / A 120 EHD		
SK 2538	03/1991 - 09/1996	A 135 APC	A 140 EHD / A 120 EHD		
SK 2538 K, 2538 LK	01/1994 - 09/1996	A 135 APC	A 140 EHD / A 120 EHD		
SK 2538 K, 2538 LK	03/1991 - 09/1996	A 135 APC	A 140 EHD / A 120 EHD		
SK 2538 S	03/1991 - 09/1996	A 135 APC	A 140 EHD / A 120 EHD		
SK 2538 S,2538 LS	07/1987 - 09/1996	A 135 APC	A 140 EHD / A 120 EHD		
SK 2538,2538 L	07/1987 - 09/1996	A 135 APC	A 140 EHD / A 120 EHD		
SK 2544	01/1994 - 09/1996	A 135 APC	A 140 EHD / A 120 EHD		
SK 2544 LS	01/1992 - 09/1996	A 135 APC	A 140 EHD / A 120 EHD		
SK 2544 S	01/1992 - 09/1996	A 135 APC	A 140 EHD / A 120 EHD		
SK 2544 S	07/1988 - 08/1994	A 135 APC	A 140 EHD / A 120 EHD		
SK 2544, 2544 L	01/1992 - 09/1996	A 135 APC	A 140 EHD / A 120 EHD		
SK 2544,2544 L	07/1987 - 09/1996	A 135 APC	A 140 EHD / A 120 EHD		
SK 2550	01/1991 - 09/1996	A 135 APC	A 140 EHD / A 120 EHD		
SK 2550	07/1987 - 09/1996	A 135 APC	A 140 EHD / A 120 EHD		
SK 2550 K	07/1987 - 09/1996	A 135 APC	A 140 EHD / A 120 EHD		
SK 2550 S, 2550 LS	01/1991 - 09/1996	A 135 APC	A 140 EHD / A 120 EHD		
SK 2550,2550 L	07/1987 - 09/1996	A 135 APC	A 140 EHD / A 120 EHD		
SK 2553 S, 2553 LS	01/1996 - 09/1996	A 135 APC	A 140 EHD / A 120 EHD		
SK 2553,2553 L	07/1987 - 09/1996	A 135 APC	A 140 EHD / A 120 EHD		

MARCHIO E MODELLO - MAKE AND MODEL MARQUE ET MODÈLE - MARKE UND MODELL MARCA Y MODELO - МАРКА И МОДЕЛЬ	Periodo Period	powerCUBE		energyCUBE	
		APC	EHD	APC	RST
MERCEDES-BENZ cont.					
SK 2629	07/1988 - 08/1994	A 135 APC	A 140 EHD / A 120 EHD		
SK 2629 A	07/1988 - 08/1994	A 135 APC	A 140 EHD / A 120 EHD		
SK 2629 AK	07/1988 - 08/1994	A 135 APC	A 140 EHD / A 120 EHD		
SK 2629 AS	07/1988 - 08/1994	A 135 APC	A 140 EHD / A 120 EHD		
SK 2629 B	07/1988 - 08/1994	A 135 APC	A 140 EHD / A 120 EHD		
SK 2629 K	07/1988 - 08/1994	A 135 APC	A 140 EHD / A 120 EHD		
SK 2629 S	07/1988 - 08/1994	A 135 APC	A 140 EHD / A 120 EHD		
SK 2631	06/1992 - 09/1996	A 135 APC	A 140 EHD / A 120 EHD		
SK 2631 A	01/1994 - 09/1996	A 135 APC	A 140 EHD / A 120 EHD		
SK 2631 A	06/1992 - 09/1996	A 135 APC	A 140 EHD / A 120 EHD		
SK 2631 AK, 2634 AK	01/1994 - 09/1996	A 135 APC	A 140 EHD / A 120 EHD		
SK 2631 AK, 2634 AK	06/1992 - 09/1996	A 135 APC	A 140 EHD / A 120 EHD		
SK 2631 AS	06/1992 - 09/1996	A 135 APC	A 140 EHD / A 120 EHD		
SK 2631 B	06/1992 - 09/1996	A 135 APC	A 140 EHD / A 120 EHD		
SK 2631 K	07/1988 - 08/1994	A 135 APC	A 140 EHD / A 120 EHD		
SK 2631 S	06/1992 - 09/1996	A 135 APC	A 140 EHD / A 120 EHD		
SK 2634	06/1992 - 09/1996	A 135 APC	A 140 EHD / A 120 EHD		
SK 2634 S	06/1992 - 09/1996	A 135 APC	A 140 EHD / A 120 EHD		
SK 2635	01/1991 - 08/1994	A 135 APC	A 140 EHD / A 120 EHD		
SK 2635	07/1988 - 08/1994	A 135 APC	A 140 EHD / A 120 EHD		
SK 2635 A	02/1990 - 08/1994	A 135 APC	A 140 EHD / A 120 EHD		
SK 2635 A	12/1991 - 08/1994	A 135 APC	A 140 EHD / A 120 EHD		
SK 2635 AK	02/1990 - 08/1994	A 135 APC	A 140 EHD / A 120 EHD		
SK 2635 AS	02/1990 - 09/1996	A 135 APC	A 140 EHD / A 120 EHD		
SK 2635 AS	02/1992 - 08/1994	A 135 APC	A 140 EHD / A 120 EHD		
SK 2635 K	01/1991 - 08/1994	A 135 APC	A 140 EHD / A 120 EHD		
SK 2635 K	07/1988 - 08/1994	A 135 APC	A 140 EHD / A 120 EHD		
SK 2635 K	07/1991 - 08/1994	A 135 APC	A 140 EHD / A 120 EHD		
SK 2635 S	07/1988 - 08/1994	A 135 APC	A 140 EHD / A 120 EHD		
SK 2638 A	09/1991 - 09/1996	A 135 APC	A 140 EHD / A 120 EHD		
SK 2638 AK	01/1994 - 09/1996	A 135 APC	A 140 EHD / A 120 EHD		
SK 2638 AK	07/1992 - 09/1996	A 135 APC	A 140 EHD / A 120 EHD		
SK 2638 AK	09/1991 - 09/1996	A 135 APC	A 140 EHD / A 120 EHD		
SK 2638 AS	01/1994 - 09/1996	A 135 APC	A 140 EHD / A 120 EHD		
SK 2638 AS	07/1992 - 09/1996	A 135 APC	A 140 EHD / A 120 EHD		
SK 2638 K	09/1991 - 09/1996	A 135 APC	A 140 EHD / A 120 EHD		
SK 2638 S	09/1991 - 09/1996	A 135 APC	A 140 EHD / A 120 EHD		
SK 2638, 2638 L	09/1991 - 09/1996	A 135 APC	A 140 EHD / A 120 EHD		
SK 2644 A	01/1992 - 09/1996	A 135 APC	A 140 EHD / A 120 EHD		
SK 2644 S	01/1992 - 09/1996	A 135 APC	A 140 EHD / A 120 EHD		
SK 2644, 2644 L	01/1992 - 09/1996	A 135 APC	A 140 EHD / A 120 EHD		
SK 2645 AS	02/1990 - 09/1996	A 135 APC	A 140 EHD / A 120 EHD		
SK 2648 AK	02/1990 - 08/1994	A 135 APC	A 140 EHD / A 120 EHD		
SK 2648 AS	07/1988 - 08/1994	A 135 APC	A 140 EHD / A 120 EHD		
SK 2648 S	12/1988 - 07/1992	A 135 APC	A 140 EHD / A 120 EHD		

MARCHIO E MODELLO - MAKE AND MODEL MARQUE ET MODÈLE - MARKE UND MODELL MARCA Y MODELO - МАРКА И МОДЕЛЬ	Periodo Period	powerCUBE		energyCUBE	
		APC	EHD	APC	RST
MERCEDES-BENZ cont.					
SK 2650	09/1995 - 09/1996	A 135 APC	A 140 EHD / A 120 EHD		
SK 2650 A	07/1987 - 09/1996	A 135 APC	A 140 EHD / A 120 EHD		
SK 2650 AK	07/1988 - 08/1994	A 135 APC	A 140 EHD / A 120 EHD		
SK 2650 AS	01/1994 - 09/1996	A 135 APC	A 140 EHD / A 120 EHD		
SK 2650 K	07/1988 - 08/1994	A 135 APC	A 140 EHD / A 120 EHD		
SK 2650 S	07/1992 - 09/1996	A 135 APC	A 140 EHD / A 120 EHD		
SK 2650, 2650 L	07/1992 - 09/1996	A 135 APC	A 140 EHD / A 120 EHD		
SK 2653 AK	07/1992 - 09/1996	A 135 APC	A 140 EHD / A 120 EHD		
SK 3053 S	01/1994 - 09/1996	A 135 APC	A 140 EHD / A 120 EHD		
SK 3053 S	12/1993 - 09/1996	A 135 APC	A 140 EHD / A 120 EHD		
SK 3229	09/1989 - 08/1994	A 135 APC	A 140 EHD / A 120 EHD		
SK 3229 B	09/1989 - 07/1992	A 135 APC	A 140 EHD / A 120 EHD		
SK 3229 K	09/1989 - 01/1992	A 135 APC	A 140 EHD / A 120 EHD		
SK 3233 B	10/1990 - 07/1992	A 135 APC	A 140 EHD / A 120 EHD		
SK 3233 K	10/1990 - 07/1992	A 135 APC	A 140 EHD / A 120 EHD		
SK 3234 B	02/1992 - 09/1996	A 135 APC	A 140 EHD / A 120 EHD		
SK 3234 K	02/1992 - 09/1996	A 135 APC	A 140 EHD / A 120 EHD		
SK 3235	07/1988 - 08/1994	A 135 APC	A 140 EHD / A 120 EHD		
SK 3235	10/1988 - 07/1992	A 135 APC	A 140 EHD / A 120 EHD		
SK 3235 K	07/1987 - 07/1992	A 135 APC	A 140 EHD / A 120 EHD		
SK 3235 L	07/1987 - 09/1996	A 135 APC	A 140 EHD / A 120 EHD		
SK 3236 A	07/1987 - 09/1996	A 135 APC	A 140 EHD / A 120 EHD		
SK 3238	03/1991 - 09/1996	A 135 APC	A 140 EHD / A 120 EHD		
SK 3238	10/1990 - 09/1996	A 135 APC	A 140 EHD / A 120 EHD		
SK 3238 L	07/1987 - 09/1996	A 135 APC	A 140 EHD / A 120 EHD		
SK 3238, 3238 L	01/1994 - 09/1996	A 135 APC	A 140 EHD / A 120 EHD		
SK 3238, 3238 L	10/1990 - 09/1996	A 135 APC	A 140 EHD / A 120 EHD		
SK 3244	01/1994 - 09/1996	A 135 APC	A 140 EHD / A 120 EHD		
SK 3244 L	07/1987 - 09/1996	A 135 APC	A 140 EHD / A 120 EHD		
SK 3248	07/1987 - 09/1996	A 135 APC	A 140 EHD / A 120 EHD		
SK 3250 L	07/1987 - 09/1996	A 135 APC	A 140 EHD / A 120 EHD		
SK 3253, 3253 L	01/1996 - 09/1996	A 135 APC	A 140 EHD / A 120 EHD		
SK 3255	07/1987 - 09/1996	A 135 APC	A 140 EHD / A 120 EHD		
SK 3529	07/1988 - 08/1994	A 135 APC	A 140 EHD / A 120 EHD		
SK 3534 K	10/1993 - 09/1996	A 135 APC	A 140 EHD / A 120 EHD		
SK 3535	07/1988 - 08/1994	A 135 APC	A 140 EHD / A 120 EHD		
SK 3535 AK	02/1990 - 08/1994	A 135 APC	A 140 EHD / A 120 EHD		
SK 3535 AK	03/1991 - 08/1994	A 135 APC	A 140 EHD / A 120 EHD		
SK 3535 B	10/1988 - 08/1994	A 135 APC	A 140 EHD / A 120 EHD		
SK 3535 K	03/1991 - 08/1994	A 135 APC	A 140 EHD / A 120 EHD		
SK 3535 K	07/1987 - 09/1996	A 135 APC	A 140 EHD / A 120 EHD		
SK 3535 K	10/1988 - 08/1994	A 135 APC	A 140 EHD / A 120 EHD		
SK 3535 S	07/1988 - 08/1994	A 135 APC	A 140 EHD / A 120 EHD		
SK 3538	03/1991 - 09/1996	A 135 APC	A 140 EHD / A 120 EHD		
SK 3538	09/1991 - 09/1996	A 135 APC	A 140 EHD / A 120 EHD		

MARCHIO E MODELLO - MAKE AND MODEL MARQUE ET MODÈLE - MARKE UND MODELL MARCA Y MODELO - МАРКА И МОДЕЛЬ	Periodo Period	powerCUBE		energyCUBE	
		APC	EHD	APC	RST
MERCEDES-BENZ					
<i>cont.</i>					
SK 3538 AK	01/1994 - 09/1996	A 135 APC	A 140 EHD / A 120 EHD		
SK 3538 AK	03/1991 - 09/1996	A 135 APC	A 140 EHD / A 120 EHD		
SK 3538 K	01/1994 - 09/1996	A 135 APC	A 140 EHD / A 120 EHD		
SK 3538 K	03/1991 - 09/1996	A 135 APC	A 140 EHD / A 120 EHD		
SK 3544	01/1992 - 09/1996	A 135 APC	A 140 EHD / A 120 EHD		
SK 3544 AK	03/1991 - 09/1996	A 135 APC	A 140 EHD / A 120 EHD		
SK 3544 K	03/1991 - 09/1996	A 135 APC	A 140 EHD / A 120 EHD		
SK 3548	05/1992 - 09/1996	A 135 APC	A 140 EHD / A 120 EHD		
SK 3550 K	03/1991 - 09/1996	A 135 APC	A 140 EHD / A 120 EHD		
SK 3550 S	05/1992 - 09/1996	A 135 APC	A 140 EHD / A 120 EHD		
SK 3550 S, 3553 S	05/1992 - 09/1996	A 135 APC	A 140 EHD / A 120 EHD		
SK 3553 S	04/1992 -	A 135 APC	A 140 EHD / A 120 EHD		
SK 3553, 3553 L	0/0 - 09/1996	A 135 APC	A 140 EHD / A 120 EHD		
SK 4050 A	07/1987 -	A 135 APC	A 140 EHD / A 120 EHD		
SK 4080 A	07/1987 -	A 135 APC	A 140 EHD / A 120 EHD		
SK 4844	12/1991 - 08/1994	A 135 APC	A 140 EHD / A 120 EHD		
SK 4844 K	03/1991 - 09/1996	A 135 APC	A 140 EHD / A 120 EHD		
SK 4850 A	07/1987 -	A 135 APC	A 140 EHD / A 120 EHD		
T2/LN1 Autobus O 609 D (672.072, 672.073)	07/1987 - 12/1992		D11 135 EHD		
T2/LN1 Autobus O 611 D (672.372, 672.373)	07/1987 - 12/1992		D11 135 EHD		
T2/LN1 Autobus O 614 D (672.375, 672.376)	07/1987 - 12/1992		D11 135 EHD		
T2/LN1 Cabina con motore 809 DT (670.199)	04/1986 - 12/1994		D11 135 EHD		
T2/LN1 Cassone / Furgonato / Promiscuo 507 D (667.361, 667.362)	04/1986 - 04/1989		D11 135 EHD		
T2/LN1 Cassone / Furgonato / Promiscuo 508 D (667.361, 667.362)	03/1989 - 12/1994		D11 135 EHD		
T2/LN1 Cassone / Furgonato / Promiscuo 510 (667.061, 667.062)	04/1986 - 12/1994		D11 135 EHD		
T2/LN1 Cassone / Furgonato / Promiscuo 609 D (668.061, 668.062, 668.063)	04/1986 - 12/1994		D11 135 EHD		
T2/LN1 Cassone / Furgonato / Promiscuo 609 D (668.061, 668.062, 668.063)	06/1994 - 12/1994		D11 135 EHD		
T2/LN1 Cassone / Furgonato / Promiscuo 611 D (668.061, 668.062, 668.063)	06/1994 - 12/1994		D11 135 EHD		
T2/LN1 Cassone / Furgonato / Promiscuo 709 D (669.061, 669.062, 669.063)	04/1986 - 12/1994		D11 135 EHD		
T2/LN1 Cassone / Furgonato / Promiscuo 711 D (669.361, 669.362, 669.363)	04/1986 - 12/1994		D11 135 EHD		
T2/LN1 Cassone / Furgonato / Promiscuo 714 D (669.361, 669.362, 669.363)	06/1994 - 12/1994		D11 135 EHD		
T2/LN1 Cassone / Furgonato / Promiscuo 809 D (670.061, 670.062, 670.063)	04/1986 - 12/1994		D11 135 EHD		
T2/LN1 Cassone / Furgonato / Promiscuo 811 D (670.362, 670.363)	04/1986 - 12/1994		D11 135 EHD		
T2/LN1 Cassone / Furgonato / Promiscuo 814 D (670.364, 670.365, 670.366)	11/1987 - 12/1994		D11 135 EHD		
T2/LN1 Cassone / Furgonato / Promiscuo 814 DA 4x4 (670.464, 670.465)	11/1987 - 12/1994		D11 135 EHD		
T2/LN1 Pianale piatto/Telaio 507 D (667.301, 667.302, 667.341, 667.342)	04/1986 - 04/1989		D11 135 EHD		
T2/LN1 Pianale piatto/Telaio 510 (667.001, 667.002)	04/1986 - 12/1994		D11 135 EHD		
T2/LN1 Pianale piatto/Telaio 609 D (668.001, 668.002, 668.003)	04/1986 - 12/1994		D11 135 EHD		
T2/LN1 Pianale piatto/Telaio 609 D (668.001, 668.002, 668.003)	06/1994 - 12/1994		D11 135 EHD		
T2/LN1 Pianale piatto/Telaio 611 D (668.001, 668.002, 668.003)	06/1994 - 12/1994		D11 135 EHD		
T2/LN1 Pianale piatto/Telaio 709 D (669.000, 669.001, 669.002, 669.003, 669.041)	04/1986 - 12/1994		D11 135 EHD		
T2/LN1 Pianale piatto/Telaio 711 D (669.301, 669.302, 669.303)	04/1986 - 12/1994		D11 135 EHD		
T2/LN1 Pianale piatto/Telaio 714 D (669.301, 669.302, 669.303)	06/1994 - 12/1994		D11 135 EHD		
T2/LN1 Pianale piatto/Telaio 809 D (670.001, 670.002, 670.003)	04/1986 - 12/1994		D11 135 EHD		
T2/LN1 Pianale piatto/Telaio 811 D (670.302, 670.303)	04/1986 - 12/1994		D11 135 EHD		

MARCHIO E MODELLO - <i>MAKE AND MODEL</i> MARQUE ET MODÈLE - <i>MARKE UND MODELL</i> MARCA Y MODELO - <i>МАРКА И МОДЕЛЬ</i>	Periodo <i>Period</i>	powerCUBE		energyCUBE	
		APC	EHD	APC	RST
MERCEDES-BENZ <i>cont.</i>					
T2/LN1 Pianale piatto/Telaio 814 D (670.312, 670.313)	11/1987 - 12/1994		D11 135 EHD		
T2/LN1 Pianale piatto/Telaio 814 DA 4x4 (670.411, 670.412)	11/1987 - 12/1994		D11 135 EHD		
T2/LN1 Ribaltabile 507 DK (667.341, 667.342)	04/1986 - 04/1989		D11 135 EHD		
T2/LN1 Ribaltabile 508 D (667.301, 667.302, 667.341, 667.342)	03/1989 - 12/1994		D11 135 EHD		
T2/LN1 Ribaltabile 609 DK (668.041, 668.042)	04/1986 - 12/1994		D11 135 EHD		
T2/LN1 Ribaltabile 611 DK (668.041, 668.042)	06/1994 - 12/1994		D11 135 EHD		
T2/LN1 Ribaltabile 709 DK (669.041, 669.042)	04/1986 - 12/1994		D11 135 EHD		
T2/LN1 Ribaltabile 809 DK (670.041, 670.042)	04/1986 - 12/1994		D11 135 EHD		
T2/LN1 Ribaltabile 811 DK (670.341, 670.342)	04/1986 - 12/1994		D11 135 EHD		
TOURINO (O 510) TOURINO	10/2003 -	CX 225 APC		CX 220 APC	
TOURISMO (O 350) Torismo	08/1995 -	CX 225 APC	CX 200 EHD	CX 220 APC	
TOURISMO (O 350) Tourismo	08/1995 -	CX 225 APC	CX 200 EHD	CX 220 APC	
TOURISMO (O 350) Tourismo 15 RHD	01/2003 -	CX 225 APC	CX 200 EHD	CX 220 APC	
TOURISMO (O 350) Tourismo 15 SHD	01/2003 -	CX 225 APC	CX 200 EHD	CX 220 APC	
TOURISMO (O 350) Tourismo 16 RHD	01/2003 -	CX 225 APC	CX 200 EHD	CX 220 APC	
TOURISMO (O 350) Tourismo 17 RHD	01/2003 -	CX 225 APC	CX 200 EHD	CX 220 APC	
TOURISMO (O 350) Tourismo RHD, SHD	09/2003 -	CX 225 APC		CX 220 APC	
TRAVEGO (O 580) 15 RH/RHD	10/1999 -	CX 225 APC	CX 200 EHD	CX 220 APC	
TRAVEGO (O 580) O 580/15 RH	10/1999 -	CX 225 APC	CX 200 EHD	CX 220 APC	
TRAVEGO (O 580) O 580-15 RH	10/1999 -	CX 225 APC		CX 220 APC	
TRAVEGO (O 580) O 580-15 RHD	10/1999 -	CX 225 APC	CX 200 EHD	CX 220 APC	
TRAVEGO (O 580) O 580-15 SHD	10/1999 -	CX 225 APC		CX 220 APC	
TRAVEGO (O 580) O 580-16 RHD		CX 225 APC	CX 200 EHD	CX 220 APC	
TRAVEGO (O 580) O 580-16 RHD	01/2003 -	CX 225 APC		CX 220 APC	
TRAVEGO (O 580) O 580-16 RHD	10/1999 -	CX 225 APC	CX 200 EHD	CX 220 APC	
TRAVEGO (O 580) O 580-17 RHD	10/1999 -	CX 225 APC	CX 200 EHD	CX 220 APC	
TRAVEGO (O 580) O 580-17 SHD	10/1999 -	CX 225 APC		CX 220 APC	
UNIMOG U 100, U 110, U 1100L	01/1977 - 05/1988	A 135 APC	A 140 EHD / A 120 EHD		
UNIMOG U 100, U 110T, U 1100T	01/1977 -	A 135 APC	A 140 EHD / A 120 EHD		
UNIMOG U 1000	01/1977 - 05/1988	A 135 APC	A 140 EHD / A 120 EHD		
UNIMOG U 1000	01/1988 -	A 135 APC	A 140 EHD / A 120 EHD		
UNIMOG U 1000T	01/1977 - 12/1982	A 135 APC	A 140 EHD / A 120 EHD		
UNIMOG U 100L	07/1996 -	A 135 APC	A 140 EHD / A 120 EHD		
UNIMOG U 100L	11/1992 -	A 135 APC	A 140 EHD / A 120 EHD		
UNIMOG U 110,U 110L	02/1992 -	A 135 APC	A 140 EHD / A 120 EHD		
UNIMOG U 1150,U 1150L	05/1988 -	A 135 APC	A 140 EHD / A 120 EHD		
UNIMOG U 1150L	05/1988 -	A 135 APC	A 140 EHD / A 120 EHD		
UNIMOG U 1200	01/1988 -	A 135 APC	A 140 EHD / A 120 EHD		
UNIMOG U 1200	02/1982 - 05/1988	A 135 APC	A 140 EHD / A 120 EHD		
UNIMOG U 1200T	01/1983 - 05/1988	A 135 APC	A 140 EHD / A 120 EHD		
UNIMOG U 1200T	01/1988 -	A 135 APC	A 140 EHD / A 120 EHD		
UNIMOG U 125, U 1100L	01/1977 - 01/1988	A 135 APC	A 140 EHD / A 120 EHD		
UNIMOG U 1250	12/1984 - 05/1988	A 135 APC	A 140 EHD / A 120 EHD		
UNIMOG U 1250,U 1250L	01/1988 -	A 135 APC	A 140 EHD / A 120 EHD		
UNIMOG U 1250L	05/1988 -	A 135 APC	A 140 EHD / A 120 EHD		

MARCHIO E MODELLO - MAKE AND MODEL MARQUE ET MODÈLE - MARKE UND MODELL MARCA Y MODELO - МАРКА И МОДЕЛЬ	Periodo Period	powerCUBE		energyCUBE	
		APC	EHD	APC	RST
MERCEDES-BENZ cont.					
UNIMOG U 130,U 140	07/1992 -	A 135 APC	A 140 EHD / A 120 EHD		
UNIMOG U 1300	01/1977 - 12/1984	A 135 APC	A 140 EHD / A 120 EHD		
UNIMOG U 1300,U 1300L	01/1977 - 05/1988	A 135 APC	A 140 EHD / A 120 EHD		
UNIMOG U 1350L	05/1988 -	A 135 APC	A 140 EHD / A 120 EHD		
UNIMOG U 1400	01/1988 -	A 135 APC	A 140 EHD / A 120 EHD		
UNIMOG U 140L	07/1992 -	A 135 APC	A 140 EHD / A 120 EHD		
UNIMOG U 140T	07/1992 -	A 135 APC	A 140 EHD / A 120 EHD		
UNIMOG U 1450,U 1450L	01/1988 -	A 135 APC	A 140 EHD / A 120 EHD		
UNIMOG U 1500	01/1977 - 05/1988	A 135 APC	A 140 EHD / A 120 EHD		
UNIMOG U 1500T	01/1977 - 05/1988	A 135 APC	A 140 EHD / A 120 EHD		
UNIMOG U 1550	01/1986 - 05/1988	A 135 APC	A 140 EHD / A 120 EHD		
UNIMOG U 1550 L	02/1986 - 05/1988	A 135 APC	A 140 EHD / A 120 EHD		
UNIMOG U 1550L	01/1992 -	A 135 APC	A 140 EHD / A 120 EHD		
UNIMOG U 1550L	05/1988 -	A 135 APC	A 140 EHD / A 120 EHD		
UNIMOG U 1600	01/1988 -	A 135 APC	A 140 EHD / A 120 EHD		
UNIMOG U 1600	05/1991 -	A 135 APC	A 140 EHD / A 120 EHD		
UNIMOG U 1600	09/1989 -	A 135 APC	A 140 EHD / A 120 EHD		
UNIMOG U 1650,U 1650L	01/1988 -	A 135 APC	A 140 EHD / A 120 EHD		
UNIMOG U 1650,U 1650L	05/1991 -	A 135 APC	A 140 EHD / A 120 EHD		
UNIMOG U 1650,U 1650L	09/1989 -	A 135 APC	A 140 EHD / A 120 EHD		
UNIMOG U 1700	09/1988 -	A 135 APC	A 140 EHD / A 120 EHD		
UNIMOG U 1700,U 1700L	05/1978 - 09/1988	A 135 APC	A 140 EHD / A 120 EHD		
UNIMOG U 1700L	05/1978 - 09/1988	A 135 APC	A 140 EHD / A 120 EHD		
UNIMOG U 1700T	09/1988 -	A 135 APC	A 140 EHD / A 120 EHD		
UNIMOG U 1750,U 1750L	09/1988 -	A 135 APC	A 140 EHD / A 120 EHD		
UNIMOG U 1800	04/1992 -	A 135 APC	A 140 EHD / A 120 EHD		
UNIMOG U 1800T	04/1992 -	A 135 APC	A 140 EHD / A 120 EHD		
UNIMOG U 1850,U 1850L	04/1992 -	A 135 APC	A 140 EHD / A 120 EHD		
UNIMOG U 2100	09/1989 -	A 135 APC	A 140 EHD / A 120 EHD		
UNIMOG U 2100T	09/1989 -	A 135 APC	A 140 EHD / A 120 EHD		
UNIMOG U 2150	09/1989 -	A 135 APC	A 140 EHD / A 120 EHD		
UNIMOG U 2150,U 2150L	09/1989 -	A 135 APC	A 140 EHD / A 120 EHD		
UNIMOG U 2400	05/1991 -	A 135 APC	A 140 EHD / A 120 EHD		
UNIMOG U 2400TG	07/1993 -	A 135 APC	A 140 EHD / A 120 EHD		
UNIMOG U 2450,U 2450L	05/1991 -	A 135 APC	A 140 EHD / A 120 EHD		
UNIMOG U 2450L	07/1993 -	A 135 APC	A 140 EHD / A 120 EHD		
UNIMOG U 300	03/2000 -	A 135 APC	A 140 EHD / A 120 EHD		
UNIMOG U 3000	09/2002 -				AT 100 RSTd
UNIMOG U 40	01/1966 - 04/1971				AT 100 RSTd
UNIMOG U 400	03/2000 -	A 135 APC	A 140 EHD / A 120 EHD		
UNIMOG U 4000	09/2002 -				AT 100 RSTd
UNIMOG U 45	01/1966 - 04/1971				AT 100 RSTd
UNIMOG U 500, UGN NA	10/2000 -	A 135 APC	A 140 EHD		
UNIMOG U 5000	09/2002 -				AT 100 RSTd
UNIMOG U 5000	11/2002 -				AT 100 RSTd

MARCHIO E MODELLO - MAKE AND MODEL MARQUE ET MODÈLE - MARKE UND MODELL MARCA Y MODELO - МАРКА И МОДЕЛЬ	Periodo Period	powerCUBE		energyCUBE	
		APC	EHD	APC	RST
MERCEDES-BENZ					
<i>cont.</i>					
UNIMOG U 52, U 60, U 600,U 600L	01/1977 - 05/1988				AT 100 RSTd
UNIMOG U 54	04/1966 - 03/1972	A 135 APC	A 140 EHD / A 120 EHD		
UNIMOG U 600	05/1988 -				AT 100 RSTd
UNIMOG U 60T, U 600T	01/1977 - 05/1988				AT 100 RSTd
UNIMOG U 650,U 650L	05/1988 -				AT 100 RSTd
UNIMOG U 66, U 72	03/1969 - 01/1988	A 135 APC	A 140 EHD / A 120 EHD		
UNIMOG U 80 T, U 90 T	05/1966 -	A 135 APC	A 140 EHD		
UNIMOG U 80, U 84, U 90	05/1969 - 01/1988	A 135 APC	A 140 EHD		
UNIMOG U 800	01/1977 - 03/1990	A 135 APC	A 140 EHD / A 120 EHD		
UNIMOG U 800	05/1988 - 03/1990	A 135 APC	A 140 EHD / A 120 EHD		
UNIMOG U 800L	01/1977 - 03/1990	A 135 APC	A 140 EHD / A 120 EHD		
UNIMOG U 90	07/1996 -	A 135 APC	A 140 EHD / A 120 EHD		
UNIMOG U 90	11/1992 -	A 135 APC	A 140 EHD / A 120 EHD		
UNIMOG U 900	01/1977 - 01/1988	A 135 APC	A 140 EHD / A 120 EHD		
UNIMOG U 900	01/1977 -	A 135 APC	A 140 EHD / A 120 EHD		
UNIMOG U 900	05/1988 -	A 135 APC	A 140 EHD / A 120 EHD		
UNIMOG U 900	11/1988 -	A 135 APC	A 140 EHD / A 120 EHD		
UNIMOG U300	03/2000 -	A 135 APC	A 140 EHD / A 120 EHD		
UNIMOG UX 100H,UX 100M	09/1996 -	A 135 APC	A 140 EHD / A 120 EHD		
ZETROS 1833 A	09/2008 -	CX 225 APC		CX 220 APC	
ZETROS 2733 A	09/2008 -	CX 225 APC		CX 220 APC	
MITSUBISHI					
Canter 413	01/2012 -				CBX 110 RST
Canter 515, 516	01/2012 -				CBX 110 RST
Canter 615, 616	01/2012 -				CBX 110 RST
Canter 616	08/2012 -				CBX 110 RST
Canter 6C18 4X4	01/2012 -				CBX 110 RST
Canter 713 ECO HYBRID	01/2012 -				CBX 110 RST
Canter 715	01/2012 -				CBX 110 RST
Canter 815, 816	01/2012 -				CBX 110 RST
Canter 916, 918	01/2012 -				CBX 110 RST
Canter Canter 35	07/1998 -				CBX 110 RST
Canter Canter 35	08/1996 - 12/1999				CBX 110 RST
Canter Canter 35	09/2001 -				CBX 110 RST
Canter Canter 55	09/2001 -				CBX 110 RST
Canter Canter 60	07/1986 -				CBX 110 RST
Canter Canter 60	08/1996 -				CBX 110 RST
Canter Canter 60	09/2001 -				CBX 110 RST
Canter Canter 75	01/1994 - 12/1997				CBX 110 RST
Canter Canter 75	09/2001 -				CBX 110 RST
Canter Canter 75	10/1997 -				CBX 110 RST

MARCHIO E MODELLO - MAKE AND MODEL MARQUE ET MODÈLE - MARKE UND MODELL MARCA Y MODELO - МАРКА И МОДЕЛЬ	Periodo Period	powerCUBE		energyCUBE	
		APC	EHD	APC	RST
MITSUBISHI					
<i>cont.</i>					
Canter FE112E4					CBX 110 RST
Canter FE122F4					CBX 110 RST
Canter FE126F4					CBX 110 RST
Canter FE130C1					CBX 110 RST
Canter FE150C1					CBX 110 RST
Canter FE150C3, FE150E3					CBX 110 RST
Canter FE150E2					CBX 110 RST
Canter FE150G1					CBX 110 RST
Canter FE150G2, FE150J1					CBX 110 RST
Canter FE155F4					CBX 110 RST
Canter FE160C1, FE160E1					CBX 110 RST
Canter FE160C2, FE160E2					CBX 110 RST
Canter FE160E3					CBX 110 RST
Canter FE160E4					CBX 110 RST
Canter FE5-109					CBX 110 RST
Canter FE6-109					CBX 110 RST
Canter FE7-136					CBX 110 RST
Canter FEI60W4					CBX 110 RST
Canter FG145C1					CBX 110 RST
Canter FG160C1, FG160E1, FG160W1					CBX 110 RST
Canter FG6-109					CBX 110 RST
CANTER Pianale piatto/Telaio (FB7, FE7, FE8, FB8) 3.0	08/2005 - 11/2010				CB 110 RST
CANTER Pianale piatto/Telaio (FB7, FE7, FE8, FB8) 3.0 TDi	08/2001 - 07/2005				ATX 100 RSTd
CANTER Pianale piatto/Telaio (FB7, FE7, FE8, FB8) 3.9	04/2006 - 07/2007				CBX 110 RST
CANTER Pianale piatto/Telaio (FB7, FE7, FE8, FB8) 3.9 TDi	08/2001 - 11/2010				ATX 100 RSTd
CANTER Pianale piatto/Telaio (FB7, FE7, FE8, FB8) 4.9 DiTD	08/2005 - 11/2010				ATX 100 RSTd
Fuso FP18-350TT					CBX 110 RST
Fuso FP410G1 AIR	09/2012 -				CBX 110 RST
Fuso FP54SGR AIR	11/2011 -				CBX 110 RST
Fuso FS470S1, FS470S2	07/2011 -				CBX 110 RST
Fuso FS52SS	11/2011 -				CBX 110 RST
Fuso FV26-350					CBX 110 RST
Fuso FV26-420					CBX 110 RST
Fuso FV470J1	07/2011 -				CBX 110 RST
Fuso FV470K1	07/2011 -				CBX 110 RST
Fuso FV51SK	11/2011 -				CBX 110 RST
Fuso FV54JR AIR	11/2011 -				CBX 110 RST
Fuso FV54ST AIR	11/2011 -				CBX 110 RST
MULTICAR					
M25 1,9	01/1991 - 12/1992	A 135 APC	A 140 EHD		
M25 2,2	01/1985 - 12/1991	A 135 APC	A 140 EHD		

MARCHIO E MODELLO - MAKE AND MODEL MARQUE ET MODÈLE - MARKE UND MODELL MARCA Y MODELO - МАРКА И МОДЕЛЬ	Periodo Period	powerCUBE		energyCUBE	
		APC	EHD	APC	RST
MULTICAR					
<small>cont.</small>					
Tremo 501	09/1998 -				CH 125 RST
NEOPLAN					
Centroliner N 4411	10/1998 -	B 180 APC	B 180 EHD	B 185 APC	
Centroliner N 4416	01/1999 - 12/2001	B 180 APC	B 180 EHD	B 185 APC	
Centroliner N 4420	01/1999 -	B 180 APC	B 180 EHD	B 185 APC	
Centroliner N 4421	01/1999 -	B 180 APC	B 180 EHD	B 185 APC	
Centroliner N 4516		B 180 APC		B 185 APC	
Centroliner N 4522		B 180 APC		B 185 APC	
Cityliner N 116	09/1990 - 09/1992	B 180 APC	B 180 EHD	B 185 APC	
Cityliner N 116	09/1990 - 09/1993	B 180 APC	B 180 EHD	B 185 APC	
Cityliner N 116	09/1990 -	B 180 APC	B 180 EHD	B 185 APC	
Cityliner N 116	09/1992 -	B 180 APC	B 180 EHD	B 185 APC	
Cityliner N 116/3 HC	09/2004 -	B 180 APC	B 180 EHD	B 185 APC	
Cityliner N 1216 HD	09/2006 -	B 180 APC	B 180 EHD	B 185 APC	
Cityliner N 1216 HDC	09/2006 -	B 180 APC	B 180 EHD	B 185 APC	
Cityliner N 122/3		B 180 APC		B 185 APC	
Cityliner N 217/3	04/1973 -	B 180 APC		B 185 APC	
Euroliner 3316 Ü		B 180 APC	B 180 EHD	B 185 APC	
Euroliner N 3316 KL, N 3316ÜL		B 180 APC	B 180 EHD	B 185 APC	
Euroliner N 3318/3 Ü		B 180 APC	B 180 EHD	B 185 APC	
Jetliner N 208	09/1990 -	B 180 APC	B 180 EHD	B 185 APC	
Jetliner N 208	09/1992 -	B 180 APC	B 180 EHD	B 185 APC	
Jetliner N 213	09/1990 - 09/1992	B 180 APC	B 180 EHD	B 185 APC	
Jetliner N 214	09/1990 - 09/1992	B 180 APC	B 180 EHD	B 185 APC	
Jetliner N 214	09/1990 - 09/1993	B 180 APC	B 180 EHD	B 185 APC	
Jetliner N 214	09/1990 -	B 180 APC	B 180 EHD	B 185 APC	
Jetliner N 214	09/1992 - 09/1993	B 180 APC	B 180 EHD	B 185 APC	
Jetliner N 214	09/1992 -	B 180 APC	B 180 EHD	B 185 APC	
Jetliner N 216	09/1990 - 09/1992	B 180 APC	B 180 EHD	B 185 APC	
Jetliner N 216	09/1990 -	B 180 APC	B 180 EHD	B 185 APC	
Megaliner N 128/4	01/1993 -	CX 225 APC	CX 200 EHD	CX 220 APC	
Megashuttle N 4032/4	01/1994 -	CX 225 APC	CX 200 EHD	CX 220 APC	
N-Serie N 416 SL	01/1983 -	B 180 APC	B 180 EHD	B 185 APC	
N-Serie N 416 SÜ	01/1987 -	CX 225 APC	CX 200 EHD	CX 220 APC	
Skyliner N 122	09/1990 - 09/1992	CX 225 APC	CX 200 EHD	CX 220 APC	
Skyliner N 122	09/1990 - 09/1993	CX 225 APC	CX 200 EHD	CX 220 APC	
Skyliner N 122/3	01/1979 -	CX 225 APC	CX 200 EHD	CX 220 APC	
Skyliner N 122/3	09/1990 - 09/1993	CX 225 APC	CX 200 EHD	CX 220 APC	
Skyliner N 122/3	09/1990 -	CX 225 APC	CX 200 EHD	CX 220 APC	
Skyliner N 122/3	09/1992 -	CX 225 APC	CX 200 EHD	CX 220 APC	
Skyliner N 122/3 L	09/2004 -	CX 225 APC	CX 200 EHD	CX 220 APC	

MARCHIO E MODELLO - MAKE AND MODEL MARQUE ET MODÈLE - MARKE UND MODELL MARCA Y MODELO - МАРКА И МОДЕЛЬ	Periodo Period	powerCUBE		energyCUBE	
		APC	EHD	APC	RST
NEOPLAN					
<i>cont.</i>					
Spaceliner N 117	09/1990 - 09/1992	CX 225 APC	CX 200 EHD	CX 220 APC	
Spaceliner N 117	09/1990 - 09/1993	CX 225 APC	CX 200 EHD	CX 220 APC	
Spaceliner N 117	09/1990 -	CX 225 APC	CX 200 EHD	CX 220 APC	
Spaceliner N 117	09/1992 -	CX 225 APC	CX 200 EHD	CX 220 APC	
Spaceliner N 117/3	09/1990 - 09/1992	CX 225 APC	CX 200 EHD	CX 220 APC	
Spaceliner N 117/3	09/1990 - 09/1993	CX 225 APC	CX 200 EHD	CX 220 APC	
Spaceliner N 117/3	09/1992 -	CX 225 APC	CX 200 EHD	CX 220 APC	
Sportliner N 208	01/1990 -	B 180 APC	B 180 EHD	B 185 APC	
Starliner 516/3	09/2002 -	CX 225 APC	CX 200 EHD	CX 220 APC	
Starliner N 2216 SHD	01/2002 -	CX 225 APC	CX 200 EHD	CX 220 APC	
Starliner N 516	09/1996 -	CX 225 APC	CX 200 EHD	CX 220 APC	
Starliner N 516//3	09/1996 -	CX 225 APC	CX 200 EHD	CX 220 APC	
Starliner N 516/3	09/1996 -	CX 225 APC	CX 200 EHD	CX 220 APC	
Starliner N 516/3	09/2002 -	CX 225 APC	CX 200 EHD	CX 220 APC	
Starliner N 5218 SHD	05/2005 -	CX 225 APC	CX 200 EHD	CX 220 APC	
Tourliner N 2216 SHD	01/2003 -	CX 225 APC	CX 200 EHD	CX 220 APC	
Tourliner N 2216 SHD	06/2006 -	CX 225 APC	CX 200 EHD	CX 220 APC	
Tourliner N 2216 SHD,SHDL	01/2003 -	CX 225 APC	CX 200 EHD	CX 220 APC	
Tourliner N 2216 SHDL	06/2006 -	CX 225 APC	CX 200 EHD	CX 220 APC	
Transliner N 314	09/1993 -	B 180 APC	B 180 EHD	B 185 APC	
Transliner N 316	09/1990 - 09/1992	B 180 APC	B 180 EHD	B 185 APC	
Transliner N 316	09/1990 - 09/1993	B 180 APC	B 180 EHD	B 185 APC	
Transliner N 316	09/1992 -	B 180 APC	B 180 EHD	B 185 APC	
Transliner N 316	09/1993 -	B 180 APC	B 180 EHD	B 185 APC	
Transliner N 316	12/1988 -	B 180 APC	B 180 EHD	B 185 APC	
Transliner N 321/3	09/1990 - 09/1992	B 180 APC	B 180 EHD	B 185 APC	
Transliner N 321/3	09/1993 -	B 180 APC	B 180 EHD	B 185 APC	
Trendliner N 3516 Ü	09/2004 -	CX 225 APC	CX 200 EHD	CX 220 APC	
Trendliner N 3516/3 ÜL	09/2004 -	CX 225 APC	CX 200 EHD	CX 220 APC	
NISSAN					
ATLEON 120.35	09/2000 -				CB 110 RST
ATLEON 120.56	09/2000 -				CB 110 RST
ATLEON 140.75	09/2000 -				CB 110 RST
ATLEON 165.75	09/2000 -				CB 110 RST
PEUGEOT					
604 2.3 TD	09/1979 - 05/1983				CB 110 RST
604 2.5 TD	08/1983 - 12/1986				CB 110 RST

MARCHIO E MODELLO - <i>MAKE AND MODEL</i> MARQUE ET MODÈLE - <i>MARKE UND MODELL</i> MARCA Y MODELO - <i>МАРКА И МОДЕЛЬ</i>	Periodo <i>Period</i>	powerCUBE		energyCUBE	
		APC	EHD	APC	RST
RENAULT TRUCKS					
AGORA Agora	01/1996 -	CX 225 APC		CX 220 APC	
Ares Ares		B 180 APC	B 180 EHD	B 185 APC	
C C 260.19T	10/1982 - 10/1998	B 180 APC	B 180 EHD	B 185 APC	
C C 300.19	04/1987 - 10/1998	B 180 APC	B 180 EHD	B 185 APC	
C C 300.24	04/1987 - 10/1998	B 180 APC	B 180 EHD	B 185 APC	
C C 340ti.17/T	07/1990 - 10/1998	B 180 APC	B 180 EHD	B 185 APC	
C CBH 280.26	04/1986 - 10/1992	B 180 APC	B 180 EHD	B 185 APC	
C CBH 280.26/T	04/1986 - 10/1992	B 180 APC	B 180 EHD	B 185 APC	
C CBH 320.24	10/1992 - 10/1998	B 180 APC	B 180 EHD	B 185 APC	
C CBH 320.24/T	10/1992 - 10/1998	B 180 APC	B 180 EHD	B 185 APC	
C CBH 320.34	10/1992 - 10/1998	B 180 APC	B 180 EHD	B 185 APC	
C CBH 320.34/T	10/1992 - 10/1998	B 180 APC	B 180 EHD	B 185 APC	
C CBH 340.19	02/1988 - 10/1992	B 180 APC	B 180 EHD	B 185 APC	
C CBH 340.19/T	02/1988 - 10/1992	B 180 APC	B 180 EHD	B 185 APC	
C CBH 340.26	02/1988 - 10/1992	B 180 APC	B 180 EHD	B 185 APC	
C CBH 340.26/T	02/1988 - 10/1992	B 180 APC	B 180 EHD	B 185 APC	
C CBH 380.26	01/1990 - 10/1992	B 180 APC	B 180 EHD	B 185 APC	
C CBH 380.26/T	04/1991 - 10/1992	B 180 APC	B 180 EHD	B 185 APC	
C CBH 385.24	10/1992 - 10/1998	B 180 APC	B 180 EHD	B 185 APC	
C CBH 385.34	10/1992 - 10/1998	B 180 APC	B 180 EHD	B 185 APC	
C CBH 385.34/T	10/1992 - 10/1998	B 180 APC	B 180 EHD	B 185 APC	
C CLM 280.19	04/1986 - 10/1992	B 180 APC	B 180 EHD	B 185 APC	
C CLM 280.26	04/1986 - 10/1992	B 180 APC	B 180 EHD	B 185 APC	
C CLM 320.19/T	10/1992 - 10/1998	B 180 APC	B 180 EHD	B 185 APC	
C CLM 320.25/T	10/1992 - 10/1998	B 180 APC	B 180 EHD	B 185 APC	
C CLM 340.19	02/1988 - 10/1991	B 180 APC	B 180 EHD	B 185 APC	
C CLM 340.19/T	02/1988 - 10/1991	B 180 APC	B 180 EHD	B 185 APC	
C CLM 385.19/T	10/1992 - 10/1998	B 180 APC	B 180 EHD	B 185 APC	
C CLM 385.25/T	10/1992 - 10/1998	B 180 APC	B 180 EHD	B 185 APC	
C CLR 220.19	05/1986 - 05/1991	B 180 APC	B 180 EHD	B 185 APC	
C CLR 230.19	09/1990 - 10/1998	B 180 APC	B 180 EHD	B 185 APC	
C-Serie 250P	01/2013 -	B 180 APC		B 185 APC	
C-Serie 250P, 250PK	01/2013 -	B 180 APC		B 185 APC	
C-Serie 280P	01/2013 -	B 180 APC		B 185 APC	
C-Serie 280P, 280PK	01/2013 -	B 180 APC		B 185 APC	
C-Serie 320P	01/2013 -	B 180 APC		B 185 APC	
C-Serie 320P, 320PK	01/2013 -	B 180 APC		B 185 APC	
C-Serie 380P	01/2013 -	B 180 APC		B 185 APC	
C-Serie 380P, 380PK	01/2013 -	B 180 APC		B 185 APC	
C-Serie 380P, 380PK, 380P XLOAD	01/2013 -	B 180 APC		B 185 APC	
C-Serie 380T, 380TK	01/2013 -	B 180 APC		B 185 APC	
C-Serie 430P	01/2013 -	B 180 APC		B 185 APC	
C-Serie 430P, 430PK	01/2013 -	B 180 APC		B 185 APC	
C-Serie 430P, 430PK, 430P XLOAD	01/2013 -	B 180 APC		B 185 APC	
C-Serie 430T, 430TK	01/2013 -	B 180 APC		B 185 APC	

MARCHIO E MODELLO - MAKE AND MODEL MARQUE ET MODÈLE - MARKE UND MODELL MARCA Y MODELO - МАРКА И МОДЕЛЬ	Periodo Period	powerCUBE		energyCUBE	
		APC	EHD	APC	RST
RENAULT TRUCKS <small>cont.</small>					
C-Serie 440P	01/2013 -	B 180 APC		B 185 APC	
C-Serie 440P, 440PK	01/2013 -	B 180 APC		B 185 APC	
C-Serie 440T, 440TK	01/2013 -	B 180 APC		B 185 APC	
C-Serie 460P	01/2013 -	B 180 APC		B 185 APC	
C-Serie 460P, 460PK	01/2013 -	B 180 APC		B 185 APC	
C-Serie 460P, 460PK, 460P XLOAD	01/2013 -	B 180 APC		B 185 APC	
C-Serie 460T, 460TK	01/2013 -	B 180 APC		B 185 APC	
C-Serie 480P	01/2013 -	B 180 APC		B 185 APC	
C-Serie 480P, 480PK	01/2013 -	B 180 APC		B 185 APC	
C-Serie 480T, 480TK	01/2013 -	B 180 APC		B 185 APC	
C-Serie 520P	01/2013 -	B 180 APC		B 185 APC	
C-Serie 520P, 520PK	01/2013 -	B 180 APC		B 185 APC	
C-Serie 520T, 520TK	01/2013 -	B 180 APC		B 185 APC	
D-Serie 10P210 Low	01/2013 -	B 180 APC		B 185 APC	
D-Serie 10P240 Low	01/2013 -	B 180 APC		B 185 APC	
D-Serie 12 P 210	01/2013 -	B 180 APC		B 185 APC	
D-Serie 12 P 240	01/2013 -	B 180 APC		B 185 APC	
D-Serie 12 P 250	01/2013 -	B 180 APC		B 185 APC	
D-Serie 12 P 280	01/2013 -	B 180 APC		B 185 APC	
D-Serie 13 P 210, 13 KP 210	01/2013 -	B 180 APC		B 185 APC	
D-Serie 13 P 240, 13 KP 240	01/2013 -	B 180 APC		B 185 APC	
D-Serie 13 P 250, 13 KP 250	01/2013 -	B 180 APC		B 185 APC	
D-Serie 13 P 280, 13 KP 280	01/2013 -	B 180 APC		B 185 APC	
D-Serie 14 P 210, 14 KP 210	01/2013 -	B 180 APC		B 185 APC	
D-Serie 14 P 240, 14 KP 240	01/2013 -	B 180 APC		B 185 APC	
D-Serie 14 P 250, 14 KP 250	01/2013 -	B 180 APC		B 185 APC	
D-Serie 14 P 280, 14 KP 280	01/2013 -	B 180 APC		B 185 APC	
D-Serie 16 P 210, 16 KP 210	01/2013 -	B 180 APC		B 185 APC	
D-Serie 16 P 240, 16 KP 240	01/2013 -	B 180 APC		B 185 APC	
D-Serie 16 P 250, 16 KP 250	01/2013 -	B 180 APC		B 185 APC	
D-Serie 16 P 280, 16 KP 280	01/2013 -	B 180 APC		B 185 APC	
D-Serie 18 P 250	01/2013 -	B 180 APC		B 185 APC	
D-Serie 18 P 250, 18 P 250 LOW	01/2013 -	B 180 APC		B 185 APC	
D-Serie 18 P 280	01/2013 -	B 180 APC		B 185 APC	
D-Serie 18 P 280, 18 P 280 LOW	01/2013 -	B 180 APC		B 185 APC	
D-Serie 18 P 320	01/2013 -	B 180 APC		B 185 APC	
D-Serie 18 P 320, 18 P 320 LOW	01/2013 -	B 180 APC		B 185 APC	
D-Serie 18T280 Wide	01/2013 -	B 180 APC		B 185 APC	
D-Serie 18T320 Wide	01/2013 -	B 180 APC		B 185 APC	
D-Serie 25 P 250 LOW	01/2013 -	B 180 APC		B 185 APC	
D-Serie 25 P 280 LOW	01/2013 -	B 180 APC		B 185 APC	
D-Serie 25 P 320 LOW	01/2013 -	B 180 APC		B 185 APC	
D-Serie 26 P 250	01/2013 -	B 180 APC		B 185 APC	
D-Serie 26 P 250, 26 P 250 LOW	01/2013 -	B 180 APC		B 185 APC	
D-Serie 26 P 280	01/2013 -	B 180 APC		B 185 APC	

MARCHIO E MODELLO - MAKE AND MODEL MARQUE ET MODÈLE - MARKE UND MODELL MARCA Y MODELO - МАРКА И МОДЕЛЬ	Periodo Period	powerCUBE		energyCUBE	
		APC	EHD	APC	RST
RENAULT TRUCKS					
cont.					
D-Serie 26 P 280, 26 P 280 LOW	01/2013 -	B 180 APC		B 185 APC	
D-Serie 26 P 320	01/2013 -	B 180 APC		B 185 APC	
D-Serie 26 P 320, 26 P 320 LOW	01/2013 -	B 180 APC		B 185 APC	
FR1 FR1	01/1983 -	CX 225 APC		CX 220 APC	
G G 200.13	05/1990 - 09/1991	A 135 APC	A 140 EHD / A 120 EHD		
G G 200.15	05/1990 - 09/1991	A 135 APC	A 140 EHD / A 120 EHD		
G G 200.16	05/1990 - 09/1991	A 135 APC	A 140 EHD / A 120 EHD		
G G 200.18	05/1990 - 09/1991	A 135 APC	A 140 EHD / A 120 EHD		
G G 210.16	11/1983 - 02/1990	A 135 APC	A 140 EHD / A 120 EHD		
G G 210.16/T	11/1983 - 02/1990	A 135 APC	A 140 EHD		
G G 210.19/T	11/1983 - 02/1990	A 135 APC	A 140 EHD		
G G 230.11	01/1985 - 05/1990	A 135 APC	A 140 EHD / A 120 EHD		
G G 230.13	01/1985 - 05/1990	A 135 APC	A 140 EHD / A 120 EHD		
G G 230.15	01/1985 - 05/1990	A 135 APC	A 140 EHD / A 120 EHD		
G G 230.15/T	01/1985 - 05/1990	A 135 APC	A 140 EHD / A 120 EHD		
G G 230.16	01/1985 - 05/1990	A 135 APC	A 140 EHD / A 120 EHD		
G G 230.17	01/1985 - 05/1990	A 135 APC	A 140 EHD / A 120 EHD		
G G 230.17/T	01/1985 - 05/1990	A 135 APC	A 140 EHD / A 120 EHD		
G G 230.19/T	01/1985 - 03/1993	A 135 APC	A 140 EHD		
G G 230ti.13	02/1990 - 08/1991	A 135 APC	A 140 EHD / A 120 EHD		
G G 230ti.15	02/1990 - 08/1991	A 135 APC	A 140 EHD / A 120 EHD		
G G 230ti.16	02/1990 - 08/1991	A 135 APC	A 140 EHD / A 120 EHD		
G G 230ti.17	02/1990 - 08/1991	A 135 APC	A 140 EHD / A 120 EHD		
G G 230ti.18	02/1990 - 08/1991	A 135 APC	A 140 EHD / A 120 EHD		
G G 230ti.19	02/1990 - 08/1991	A 135 APC	A 140 EHD		
G G 260.15/T	10/1982 - 05/1990	A 135 APC	A 140 EHD / A 120 EHD		
G G 260.16	10/1982 - 05/1990	A 135 APC	A 140 EHD / A 120 EHD		
G G 260.17	01/1990 - 09/1991	A 135 APC	A 140 EHD / A 120 EHD		
G G 260.17	10/1982 - 05/1990	A 135 APC	A 140 EHD / A 120 EHD		
G G 260.17/T	10/1982 - 05/1990	A 135 APC	A 140 EHD / A 120 EHD		
G G 260.19	10/1982 - 05/1990	A 135 APC	A 140 EHD / A 120 EHD		
G G 260.19/T	10/1982 - 05/1990	A 135 APC	A 140 EHD		
G G 260.22/T	10/1982 - 05/1990	A 135 APC	A 140 EHD / A 120 EHD		
G G 260.24 CIT	10/1982 - 05/1990	A 135 APC	A 140 EHD / A 120 EHD		
G G 280.13	01/1990 - 09/1991	A 135 APC	A 140 EHD / A 120 EHD		
G G 280.15	01/1990 - 09/1991	A 135 APC	A 140 EHD / A 120 EHD		
G G 280.15/T	01/1990 - 09/1991	A 135 APC	A 140 EHD / A 120 EHD		
G G 280.16	01/1990 - 09/1991	A 135 APC	A 140 EHD / A 120 EHD		
G G 280.18	01/1990 - 09/1991	A 135 APC	A 140 EHD / A 120 EHD		
G G 280.24	01/1990 - 09/1991	A 135 APC	A 140 EHD / A 120 EHD		
G G 280.26	01/1990 - 09/1991	A 135 APC	A 140 EHD / A 120 EHD		
G G 290.17/TD	11/1985 - 12/1989	A 135 APC	A 140 EHD / A 120 EHD		
G G 290.19	11/1985 - 12/1989	A 135 APC	A 140 EHD		
G G 290.19/T	11/1985 - 12/1989	A 135 APC	A 140 EHD		
G G 290.22/TD	11/1985 - 12/1989	A 135 APC	A 140 EHD / A 120 EHD		

MARCHIO E MODELLO - MAKE AND MODEL MARQUE ET MODÈLE - MARKE UND MODELL MARCA Y MODELO - МАРКА И МОДЕЛЬ	Periodo Period	powerCUBE		energyCUBE	
		APC	EHD	APC	RST
RENAULT TRUCKS					
<i>cont.</i>					
G G 290.24	11/1985 - 12/1989	A 135 APC	A 140 EHD / A 120 EHD		
G G 290.24 CIT	11/1985 - 12/1989	A 135 APC	A 140 EHD / A 120 EHD		
G G 290.26	11/1985 - 12/1989	A 135 APC	A 140 EHD / A 120 EHD		
G G 300.13	01/1990 - 08/1991	A 135 APC	A 140 EHD / A 120 EHD		
G G 300.15	01/1990 - 08/1991	A 135 APC	A 140 EHD / A 120 EHD		
G G 300.16	01/1990 - 08/1991	A 135 APC	A 140 EHD / A 120 EHD		
G G 300.17	01/1990 - 08/1991	A 135 APC	A 140 EHD / A 120 EHD		
G G 300.24	01/1990 - 08/1991	A 135 APC	A 140 EHD / A 120 EHD		
G G 300.25	01/1990 - 08/1991	A 135 APC	A 140 EHD / A 120 EHD		
G G 300.26	01/1990 - 08/1991	A 135 APC	A 140 EHD / A 120 EHD		
G G 320.19	11/1988 - 05/1990	A 135 APC	A 140 EHD / A 120 EHD		
G G 320.19 T	11/1988 - 05/1990	A 135 APC	A 140 EHD / A 120 EHD		
G G 330.13	02/1990 - 08/1991	A 135 APC	A 140 EHD / A 120 EHD		
G G 330.15	02/1990 - 08/1991	A 135 APC	A 140 EHD / A 120 EHD		
G G 330.16	02/1990 - 08/1991	A 135 APC	A 140 EHD / A 120 EHD		
G G 330.17	02/1990 - 08/1991	A 135 APC	A 140 EHD / A 120 EHD		
G G 330.17/T	02/1990 - 08/1991	A 135 APC	A 140 EHD / A 120 EHD		
G G 330.24	02/1990 - 08/1991	A 135 APC	A 140 EHD / A 120 EHD		
G G 330.26	02/1990 - 08/1991	A 135 APC	A 140 EHD / A 120 EHD		
G G320	11/1988 - 05/1990	A 135 APC	A 140 EHD / A 120 EHD		
Iliade FRH, GTX, GTXE, RTX, TX	01/1997 -	B 180 APC	B 180 EHD	B 185 APC	
Iliade GT, GTC, GTE	04/1998 -	B 180 APC	B 180 EHD	B 185 APC	
Kerax 260.18	06/1997 -	B 180 APC	B 180 EHD / B 160 EHD	B 185 APC	
Kerax 260.18/B	06/1997 -	B 180 APC	B 180 EHD / B 160 EHD	B 185 APC	
Kerax 270.18	01/2001 -	B 180 APC	B 180 EHD / B 160 EHD	B 185 APC	
Kerax 300.18/B	06/1997 -	B 180 APC	B 180 EHD / B 160 EHD	B 185 APC	
Kerax 300.26/A,300.26/B	06/1997 -	B 180 APC	B 180 EHD / B 160 EHD	B 185 APC	
Kerax 300.26/B	06/1997 -	B 180 APC	B 180 EHD / B 160 EHD	B 185 APC	
Kerax 320.18	01/2001 -	B 180 APC	B 180 EHD / B 160 EHD	B 185 APC	
Kerax 320.26	01/2001 -	B 180 APC	B 180 EHD / B 160 EHD	B 185 APC	
Kerax 340.18	06/1997 -	B 180 APC	B 180 EHD / B 160 EHD	B 185 APC	
Kerax 340.18/B	06/1997 -	B 180 APC	B 180 EHD / B 160 EHD	B 185 APC	
Kerax 340.26	06/1997 - 01/2001	B 180 APC	B 180 EHD / B 160 EHD	B 185 APC	
Kerax 340.26/A,340.26/B	06/1997 -	B 180 APC	B 180 EHD / B 160 EHD	B 185 APC	
Kerax 340.26/B	06/1997 -	B 180 APC	B 180 EHD / B 160 EHD	B 185 APC	
Kerax 340.32/A	06/1997 -	B 180 APC	B 180 EHD / B 160 EHD	B 185 APC	
Kerax 350.34	01/2003 -	B 180 APC	B 180 EHD	B 185 APC	
Kerax 370.18	01/2001 -	B 180 APC	B 180 EHD / B 160 EHD	B 185 APC	
Kerax 370.18	10/2005 -	B 180 APC	B 180 EHD	B 185 APC	
Kerax 370.26	01/2001 -	B 180 APC	B 180 EHD / B 160 EHD	B 185 APC	
Kerax 370.26	10/2005 -	B 180 APC	B 180 EHD	B 185 APC	
Kerax 370.32	01/2001 -	B 180 APC	B 180 EHD / B 160 EHD	B 185 APC	
Kerax 370.32	10/2005 -	B 180 APC	B 180 EHD	B 185 APC	
Kerax 385.18	06/1997 -	B 180 APC	B 180 EHD / B 160 EHD	B 185 APC	
Kerax 385.18/B	06/1997 -	B 180 APC	B 180 EHD / B 160 EHD	B 185 APC	

MARCHIO E MODELLO - MAKE AND MODEL MARQUE ET MODÈLE - MARKE UND MODELL MARCA Y MODELO - МАРКА И МОДЕЛЬ	Periodo Period	powerCUBE		energyCUBE	
		APC	EHD	APC	RST
RENAULT TRUCKS cont.					
Kerax 385.18T	06/1997 -	B 180 APC	B 180 EHD / B 160 EHD	B 185 APC	
Kerax 385.26	06/1997 -	B 180 APC	B 180 EHD / B 160 EHD	B 185 APC	
Kerax 385.26/A,385.26/B	06/1997 -	B 180 APC	B 180 EHD / B 160 EHD	B 185 APC	
Kerax 385.26/A,385.26/B,385.26/C	06/1997 -	B 180 APC	B 180 EHD / B 160 EHD	B 185 APC	
Kerax 385.26/B	06/1997 -	B 180 APC	B 180 EHD / B 160 EHD	B 185 APC	
Kerax 385.26T	06/1997 -	B 180 APC	B 180 EHD / B 160 EHD	B 185 APC	
Kerax 385.32/A,385.32/B	06/1997 -	B 180 APC	B 180 EHD / B 160 EHD	B 185 APC	
Kerax 385.32/A,385.32/B,385.32/C	06/1997 -	B 180 APC	B 180 EHD / B 160 EHD	B 185 APC	
Kerax 385.32/B	06/1997 -	B 180 APC	B 180 EHD / B 160 EHD	B 185 APC	
Kerax 400.18	01/2000 -	B 180 APC	B 180 EHD / B 160 EHD	B 185 APC	
Kerax 400.18T	01/2000 -	B 180 APC	B 180 EHD / B 160 EHD	B 185 APC	
Kerax 400.26	09/1998 -	B 180 APC	B 180 EHD / B 160 EHD	B 185 APC	
Kerax 400.26/A,400.26/B,400.26/C	01/2000 -	B 180 APC	B 180 EHD / B 160 EHD	B 185 APC	
Kerax 400.26/B	01/2000 -	B 180 APC	B 180 EHD / B 160 EHD	B 185 APC	
Kerax 400.26T	01/2000 -	B 180 APC	B 180 EHD / B 160 EHD	B 185 APC	
Kerax 400.32/A,400.32/B,400.32/C	01/2000 -	B 180 APC	B 180 EHD / B 160 EHD	B 185 APC	
Kerax 400.32/B	01/2000 -	B 180 APC	B 180 EHD / B 160 EHD	B 185 APC	
Kerax 410.18	10/2005 -	B 180 APC	B 180 EHD	B 185 APC	
Kerax 410.26	10/2005 -	B 180 APC	B 180 EHD	B 185 APC	
Kerax 410.32	10/2005 -	B 180 APC	B 180 EHD	B 185 APC	
Kerax 420.18	01/2001 -	B 180 APC	B 180 EHD / B 160 EHD	B 185 APC	
Kerax 420.26	01/2001 -	B 180 APC	B 180 EHD / B 160 EHD	B 185 APC	
Kerax 420.32	10/2001 -	B 180 APC	B 180 EHD / B 160 EHD	B 185 APC	
Kerax 420.34	01/2001 -	B 180 APC	B 180 EHD / B 160 EHD	B 185 APC	
Kerax 450.18	10/2005 -	B 180 APC	B 180 EHD	B 185 APC	
Kerax 450.26	10/2005 -	B 180 APC	B 180 EHD	B 185 APC	
Kerax 450.32	10/2005 -	B 180 APC	B 180 EHD	B 185 APC	
Kerax 460.32	05/2006 -	B 180 APC	B 180 EHD	B 185 APC	
Kerax 500.32	05/2006 -	B 180 APC	B 180 EHD	B 185 APC	
K-Serie 380P MEDIUM, 380P HEAVY	01/2013 -	B 180 APC		B 185 APC	
K-Serie 380P MEDIUM, 380P HEAVY, 380P XTREM	01/2013 -	B 180 APC		B 185 APC	
K-Serie 380T MEDIUM, 380T HEAVY	01/2013 -	B 180 APC		B 185 APC	
K-Serie 430P MEDIUM, 430P HEAVY	01/2013 -	B 180 APC		B 185 APC	
K-Serie 430P MEDIUM, 430P HEAVY, 430P XTREM	01/2013 -	B 180 APC		B 185 APC	
K-Serie 430T MEDIUM, 430T HEAVY	01/2013 -	B 180 APC		B 185 APC	
K-Serie 440P MEDIUM, 440P HEAVY	01/2013 -	B 180 APC		B 185 APC	
K-Serie 440P MEDIUM, 440P HEAVY, 440P XTREM	01/2013 -	B 180 APC		B 185 APC	
K-Serie 440T MEDIUM, 440T HEAVY	01/2013 -	B 180 APC		B 185 APC	
K-Serie 460P MEDIUM, 460P HEAVY	01/2013 -	B 180 APC		B 185 APC	
K-Serie 460P MEDIUM, 460P HEAVY, 480P XTREM	01/2013 -	B 180 APC		B 185 APC	
K-Serie 460T MEDIUM, 460T HEAVY	01/2013 -	B 180 APC		B 185 APC	
K-Serie 480P MEDIUM, 480P HEAVY	01/2013 -	B 180 APC		B 185 APC	
K-Serie 480P MEDIUM, 480P HEAVY, 480P XTREM	01/2013 -	B 180 APC		B 185 APC	
K-Serie 480T MEDIUM, 480T HEAVY	01/2013 -	B 180 APC		B 185 APC	
K-Serie 520P MEDIUM, 520P HEAVY	01/2013 -	B 180 APC		B 185 APC	

MARCHIO E MODELLO - MAKE AND MODEL MARQUE ET MODÈLE - MARKE UND MODELL MARCA Y MODELO - МАРКА И МОДЕЛЬ	Periodo Period	powerCUBE		energyCUBE	
		APC	EHD	APC	RST
RENAULT TRUCKS					
<i>cont.</i>					
K-Serie 520P MEDIUM, 520P HEAVY, 520P XTREM	01/2013 -	B 180 APC		B 185 APC	
K-Serie 520T MEDIUM, 520T HEAVY	01/2013 -	B 180 APC		B 185 APC	
Magnum AE 380.18	09/1990 - 06/1992	B 180 APC	B 180 EHD	B 185 APC	
Magnum AE 380.18T	09/1990 - 06/1992	B 180 APC	B 180 EHD	B 185 APC	
Magnum AE 380.26	09/1990 - 06/1992	B 180 APC	B 180 EHD	B 185 APC	
Magnum AE 380.26T	09/1990 - 06/1992	B 180 APC	B 180 EHD	B 185 APC	
Magnum AE 385ti.18	02/1992 - 10/1996	B 180 APC	B 180 EHD / B 160 EHD	B 185 APC	
Magnum AE 385ti.18T	02/1992 - 10/1996	B 180 APC	B 180 EHD / B 160 EHD	B 185 APC	
Magnum AE 385ti.26	02/1992 - 10/1996	B 180 APC	B 180 EHD / B 160 EHD	B 185 APC	
Magnum AE 390.18	09/1996 -	B 180 APC	B 180 EHD / B 160 EHD	B 185 APC	
Magnum AE 390.18T	09/1996 -	B 180 APC	B 180 EHD / B 160 EHD	B 185 APC	
Magnum AE 390.26	09/1996 -	B 180 APC	B 180 EHD / B 160 EHD	B 185 APC	
Magnum AE 420ti.18	10/1992 - 12/1996	B 180 APC	B 180 EHD / B 160 EHD	B 185 APC	
Magnum AE 420ti.18T	10/1992 - 12/1996	B 180 APC	B 180 EHD / B 160 EHD	B 185 APC	
Magnum AE 420ti.24T	10/1992 - 12/1996	B 180 APC	B 180 EHD / B 160 EHD	B 185 APC	
Magnum AE 420ti.26	10/1992 - 12/1996	B 180 APC	B 180 EHD / B 160 EHD	B 185 APC	
Magnum AE 420ti.26T	10/1992 - 12/1996	B 180 APC	B 180 EHD / B 160 EHD	B 185 APC	
Magnum AE 430.18	09/1996 -	B 180 APC	B 180 EHD / B 160 EHD	B 185 APC	
Magnum AE 430.18T	09/1996 -	B 180 APC	B 180 EHD / B 160 EHD	B 185 APC	
Magnum AE 430.26	09/1996 -	B 180 APC	B 180 EHD / B 160 EHD	B 185 APC	
Magnum AE 430.26T	01/1997 -	B 180 APC	B 180 EHD / B 160 EHD	B 185 APC	
Magnum AE 430.26T	01/1998 -	B 180 APC	B 180 EHD / B 160 EHD	B 185 APC	
Magnum AE 470.18	11/1996 -	B 180 APC	B 180 EHD / B 160 EHD	B 185 APC	
Magnum AE 470.18T	11/1996 -	B 180 APC	B 180 EHD / B 160 EHD	B 185 APC	
Magnum AE 470.26	01/1997 -	B 180 APC	B 180 EHD / B 160 EHD	B 185 APC	
Magnum AE 470.26T	01/1998 -	B 180 APC	B 180 EHD / B 160 EHD	B 185 APC	
Magnum AE 500.18	09/1990 - 09/1990	B 180 APC	B 180 EHD	B 185 APC	
Magnum AE 500.18T	09/1990 - 09/1990	B 180 APC	B 180 EHD	B 185 APC	
Magnum AE 500.26	09/1990 - 09/1990	B 180 APC	B 180 EHD	B 185 APC	
Magnum AE 500.26T	09/1990 - 09/1990	B 180 APC	B 180 EHD	B 185 APC	
Magnum AE 520.18	10/1992 - 05/1996	B 180 APC	B 180 EHD / B 160 EHD	B 185 APC	
Magnum AE 520.18T	10/1992 - 05/1996	B 180 APC	B 180 EHD / B 160 EHD	B 185 APC	
Magnum AE 520.24T	10/1992 - 05/1996	B 180 APC	B 180 EHD / B 160 EHD	B 185 APC	
Magnum AE 520.26	10/1992 -	B 180 APC	B 180 EHD / B 160 EHD	B 185 APC	
Magnum AE 520.26T	10/1992 - 05/1996	B 180 APC	B 180 EHD / B 160 EHD	B 185 APC	
Magnum AE 560.18	04/1996 -	B 180 APC	B 180 EHD / B 160 EHD	B 185 APC	
Magnum AE 560.18T	04/1996 -	B 180 APC	B 180 EHD / B 160 EHD	B 185 APC	
Magnum AE 560.26	04/1996 -	B 180 APC	B 180 EHD / B 160 EHD	B 185 APC	
Magnum AE 560.26T	01/1997 -	B 180 APC	B 180 EHD / B 160 EHD	B 185 APC	
Magnum AE 560.26T	01/1998 -	B 180 APC	B 180 EHD / B 160 EHD	B 185 APC	
Magnum DXi 12 440.18	10/2004 - 04/2006	B 180 APC	B 180 EHD / B 160 EHD	B 185 APC	
Magnum DXi 12 440.18 T	10/2004 - 04/2006	B 180 APC	B 180 EHD / B 160 EHD	B 185 APC	
Magnum DXi 12 440.24	10/2004 - 04/2006	B 180 APC	B 180 EHD / B 160 EHD	B 185 APC	
Magnum DXi 12 440.26	10/2004 - 04/2006	B 180 APC	B 180 EHD / B 160 EHD	B 185 APC	
Magnum DXi 12 440.26 T	10/2004 - 04/2006	B 180 APC	B 180 EHD / B 160 EHD	B 185 APC	

MARCHIO E MODELLO - MAKE AND MODEL MARQUE ET MODÈLE - MARKE UND MODELL MARCA Y MODELO - МАРКА И МОДЕЛЬ	Periodo Period	powerCUBE		energyCUBE	
		APC	EHD	APC	RST
RENAULT TRUCKS cont.					
Magnum DXi 12 480.18	10/2004 - 04/2006	B 180 APC	B 180 EHD / B 160 EHD	B 185 APC	
Magnum DXi 12 480.18 T	10/2004 - 04/2006	B 180 APC	B 180 EHD / B 160 EHD	B 185 APC	
Magnum DXi 12 480.24	10/2004 - 04/2006	B 180 APC	B 180 EHD / B 160 EHD	B 185 APC	
Magnum DXi 12 480.26	10/2004 - 04/2006	B 180 APC	B 180 EHD / B 160 EHD	B 185 APC	
Magnum DXi 12 480.26 T	10/2004 - 04/2006	B 180 APC	B 180 EHD / B 160 EHD	B 185 APC	
Magnum DXi 13 440.19	03/2009 -	B 180 APC	B 180 EHD / B 160 EHD	B 185 APC	
Magnum DXi 13 460.18 T	05/2006 -	B 180 APC	B 180 EHD / B 160 EHD	B 185 APC	
Magnum DXi 13 460.24	05/2006 -	B 180 APC	B 180 EHD / B 160 EHD	B 185 APC	
Magnum DXi 13 460.25	05/2006 -	B 180 APC	B 180 EHD / B 160 EHD	B 185 APC	
Magnum DXi 13 460.26	05/2006 -	B 180 APC	B 180 EHD / B 160 EHD	B 185 APC	
Magnum DXi 13 460.26 T	05/2006 -	B 180 APC	B 180 EHD / B 160 EHD	B 185 APC	
Magnum DXi 13 480.19	03/2009 -	B 180 APC	B 180 EHD / B 160 EHD	B 185 APC	
Magnum DXi 13 480.26	03/2009 -	B 180 APC	B 180 EHD / B 160 EHD	B 185 APC	
Magnum DXi 13 500.18 T	05/2006 -	B 180 APC	B 180 EHD / B 160 EHD	B 185 APC	
Magnum DXi 13 500.24	05/2006 -	B 180 APC	B 180 EHD / B 160 EHD	B 185 APC	
Magnum DXi 13 500.25	05/2006 -	B 180 APC	B 180 EHD / B 160 EHD	B 185 APC	
Magnum DXi 13 500.26	05/2006 -	B 180 APC	B 180 EHD / B 160 EHD	B 185 APC	
Magnum DXi 13 500.26 T	05/2006 -	B 180 APC	B 180 EHD / B 160 EHD	B 185 APC	
Magnum DXi 13 520.18	08/2009 -	B 180 APC	B 180 EHD	B 185 APC	
Magnum DXi 13 520.19	08/2009 -	B 180 APC	B 180 EHD / B 160 EHD	B 185 APC	
Magnum DXi 13 520.24	08/2009 -	B 180 APC	B 180 EHD / B 160 EHD	B 185 APC	
Magnum DXi 13 520.25	08/2009 -	B 180 APC	B 180 EHD / B 160 EHD	B 185 APC	
Magnum DXi 13 520.26	08/2009 -	B 180 APC	B 180 EHD / B 160 EHD	B 185 APC	
Magnum E.TECH E.TECH 400.18	05/2000 -	B 180 APC	B 180 EHD / B 160 EHD	B 185 APC	
Magnum E.TECH E.TECH 400.18T	05/2000 -	B 180 APC	B 180 EHD / B 160 EHD	B 185 APC	
Magnum E.TECH E.TECH 400.24	05/2000 -	B 180 APC	B 180 EHD / B 160 EHD	B 185 APC	
Magnum E.TECH E.TECH 400.26	05/2000 -	B 180 APC	B 180 EHD / B 160 EHD	B 185 APC	
Magnum E.TECH E.TECH 440.18	05/2000 -	B 180 APC	B 180 EHD / B 160 EHD	B 185 APC	
Magnum E.TECH E.TECH 440.18T	05/2000 -	B 180 APC	B 180 EHD / B 160 EHD	B 185 APC	
Magnum E.TECH E.TECH 440.24	05/2000 -	B 180 APC	B 180 EHD / B 160 EHD	B 185 APC	
Magnum E.TECH E.TECH 440.26	05/2000 -	B 180 APC	B 180 EHD / B 160 EHD	B 185 APC	
Magnum E.TECH E.TECH 440.26T	05/2000 -	B 180 APC	B 180 EHD / B 160 EHD	B 185 APC	
Magnum E.TECH E.TECH 480.18	05/2000 -	B 180 APC	B 180 EHD / B 160 EHD	B 185 APC	
Magnum E.TECH E.TECH 480.18T	05/2000 -	B 180 APC	B 180 EHD / B 160 EHD	B 185 APC	
Magnum E.TECH E.TECH 480.24	05/2000 -	B 180 APC	B 180 EHD / B 160 EHD	B 185 APC	
Magnum E.TECH E.TECH 480.26	05/2000 -	B 180 APC	B 180 EHD / B 160 EHD	B 185 APC	
Magnum E.TECH E.TECH 480.26T	05/2000 -	B 180 APC	B 180 EHD / B 160 EHD	B 185 APC	
Major R 340ti.16/T	05/1991 - 10/1996	B 180 APC	B 180 EHD / B 160 EHD	B 185 APC	
Major R 340ti.18	05/1991 - 10/1996	B 180 APC	B 180 EHD / B 160 EHD	B 185 APC	
Major R 340ti.18/T	05/1991 - 10/1996	B 180 APC	B 180 EHD / B 160 EHD	B 185 APC	
Major R 340ti.24	05/1991 - 10/1996	B 180 APC	B 180 EHD / B 160 EHD	B 185 APC	
Major R 340ti.26	05/1991 - 10/1996	B 180 APC	B 180 EHD / B 160 EHD	B 185 APC	
Major R 350.17	05/1991 - 12/1992	B 180 APC	B 180 EHD / B 160 EHD	B 185 APC	
Major R 350.17/T	05/1991 - 12/1992	B 180 APC	B 180 EHD / B 160 EHD	B 185 APC	
Major R 350.18	05/1991 - 12/1992	B 180 APC	B 180 EHD / B 160 EHD	B 185 APC	

MARCHIO E MODELLO - MAKE AND MODEL MARQUE ET MODÈLE - MARKE UND MODELL MARCA Y MODELO - МАРКА И МОДЕЛЬ	Periodo Period	powerCUBE		energyCUBE	
		APC	EHD	APC	RST
RENAULT TRUCKS					
<i>cont.</i>					
Major R 350.18/T	05/1991 - 12/1992	B 180 APC	B 180 EHD / B 160 EHD	B 185 APC	
Major R 350.26	05/1991 - 12/1992	B 180 APC	B 180 EHD / B 160 EHD	B 185 APC	
Major R 380.25	05/1991 - 12/1992	B 180 APC	B 180 EHD / B 160 EHD	B 185 APC	
Major R 385ti.18,R 380.18	05/1991 - 10/1996	B 180 APC	B 180 EHD / B 160 EHD	B 185 APC	
Major R 385ti.18/T,R 380.18/T	05/1991 - 10/1996	B 180 APC	B 180 EHD / B 160 EHD	B 185 APC	
Major R 385ti.24,R 380.24	05/1991 - 10/1996	B 180 APC	B 180 EHD / B 160 EHD	B 185 APC	
Major R 385ti.25,R 380.25	05/1991 - 10/1996	B 180 APC	B 180 EHD / B 160 EHD	B 185 APC	
Major R 385ti.25/T,R 380.25/T	05/1991 - 10/1996	B 180 APC	B 180 EHD / B 160 EHD	B 185 APC	
Major R 385ti.26	12/1991 - 10/1996	B 180 APC	B 180 EHD / B 160 EHD	B 185 APC	
Major R 385ti.26,R 380.26	05/1991 - 10/1996	B 180 APC	B 180 EHD / B 160 EHD	B 185 APC	
Major R 385ti.26/T,R 380.26/T	05/1991 - 10/1996	B 180 APC	B 180 EHD / B 160 EHD	B 185 APC	
Major R 420ti.18/T	10/1992 - 10/1996	B 180 APC	B 180 EHD / B 160 EHD	B 185 APC	
Major R 420ti.24/TS	04/1992 - 10/1996	B 180 APC	B 180 EHD / B 160 EHD	B 185 APC	
Major R 420ti.26/TS	04/1992 - 10/1996	B 180 APC	B 180 EHD / B 160 EHD	B 185 APC	
Major R 420ti.35/TS	04/1992 - 10/1996	B 180 APC	B 180 EHD / B 160 EHD	B 185 APC	
Manager G 200.13	09/1991 - 03/1993	B 180 APC	B 180 EHD / B 160 EHD	B 185 APC	
Manager G 200.15	09/1991 - 03/1993	B 180 APC	B 180 EHD / B 160 EHD	B 185 APC	
Manager G 200.16	09/1991 - 03/1993	B 180 APC	B 180 EHD / B 160 EHD	B 185 APC	
Manager G 200.18	09/1991 - 03/1993	B 180 APC	B 180 EHD / B 160 EHD	B 185 APC	
Manager G 210.16	05/1992 - 10/1996	B 180 APC	B 180 EHD / B 160 EHD	B 185 APC	
Manager G 210.18	05/1992 - 10/1996	B 180 APC	B 180 EHD / B 160 EHD	B 185 APC	
Manager G 230ti.13	09/1991 - 03/1993	B 180 APC	B 180 EHD / B 160 EHD	B 185 APC	
Manager G 230ti.15	09/1991 - 03/1993	B 180 APC	B 180 EHD / B 160 EHD	B 185 APC	
Manager G 230ti.16	09/1991 - 10/1996	B 180 APC	B 180 EHD / B 160 EHD	B 185 APC	
Manager G 230ti.17	09/1991 - 10/1996	B 180 APC	B 180 EHD / B 160 EHD	B 185 APC	
Manager G 230ti.18	05/1992 - 10/1996	B 180 APC	B 180 EHD / B 160 EHD	B 185 APC	
Manager G 270.18,G 270.17	11/1992 - 10/1996	B 180 APC	B 180 EHD / B 160 EHD	B 185 APC	
Manager G 280.13,G 270.13	09/1991 - 10/1996	B 180 APC	B 180 EHD / B 160 EHD	B 185 APC	
Manager G 280.15,G 270.15	09/1991 - 10/1996	B 180 APC	B 180 EHD / B 160 EHD	B 185 APC	
Manager G 280.15/T,G 270.15/T	09/1991 - 10/1996	B 180 APC	B 180 EHD / B 160 EHD	B 185 APC	
Manager G 280.16	09/1991 - 03/1993	B 180 APC	B 180 EHD / B 160 EHD	B 185 APC	
Manager G 280.16,G 270.16	09/1991 - 10/1996	B 180 APC	B 180 EHD / B 160 EHD	B 185 APC	
Manager G 280.17,G 270.18	09/1991 - 10/1996	B 180 APC	B 180 EHD / B 160 EHD	B 185 APC	
Manager G 280.17/T,G 270.17/T	09/1991 - 10/1996	B 180 APC	B 180 EHD / B 160 EHD	B 185 APC	
Manager G 280.18,G 270.18,G 270.17	09/1991 - 10/1996	B 180 APC	B 180 EHD / B 160 EHD	B 185 APC	
Manager G 280.24	09/1991 - 03/1993	B 180 APC	B 180 EHD / B 160 EHD	B 185 APC	
Manager G 280.26,G 270.26	09/1991 - 10/1996	B 180 APC	B 180 EHD / B 160 EHD	B 185 APC	
Manager G 300.13	09/1991 - 10/1996	B 180 APC	B 180 EHD / B 160 EHD	B 185 APC	
Manager G 300.15	09/1991 - 10/1996	B 180 APC	B 180 EHD / B 160 EHD	B 185 APC	
Manager G 300.16	09/1991 - 10/1996	B 180 APC	B 180 EHD / B 160 EHD	B 185 APC	
Manager G 300.17	09/1991 - 10/1996	B 180 APC	B 180 EHD / B 160 EHD	B 185 APC	
Manager G 300.17/T	09/1992 - 10/1996	B 180 APC	B 180 EHD / B 160 EHD	B 185 APC	
Manager G 300.18	09/1992 - 10/1996	B 180 APC	B 180 EHD / B 160 EHD	B 185 APC	
Manager G 300.24	09/1991 - 10/1996	B 180 APC	B 180 EHD / B 160 EHD	B 185 APC	
Manager G 300.25	09/1991 - 10/1996	B 180 APC	B 180 EHD / B 160 EHD	B 185 APC	

MARCHIO E MODELLO - <i>MAKE AND MODEL</i> MARQUE ET MODÈLE - <i>MARKE UND MODELL</i> MARCA Y MODELO - <i>МАРКА И МОДЕЛЬ</i>	Periodo <i>Period</i>	powerCUBE		energyCUBE	
		APC	EHD	APC	RST
RENAULT TRUCKS					
cont.					
Manager G 300.26	09/1991 - 10/1996	B 180 APC	B 180 EHD / B 160 EHD	B 185 APC	
Manager G 330.13	09/1991 - 03/1993	B 180 APC	B 180 EHD / B 160 EHD	B 185 APC	
Manager G 330.15	09/1991 - 03/1993	B 180 APC	B 180 EHD / B 160 EHD	B 185 APC	
Manager G 330.17	09/1991 - 03/1993	B 180 APC	B 180 EHD / B 160 EHD	B 185 APC	
Manager G 330.18	09/1991 - 03/1993	B 180 APC	B 180 EHD / B 160 EHD	B 185 APC	
Manager G 330.24	09/1991 - 03/1993	B 180 APC	B 180 EHD / B 160 EHD	B 185 APC	
Manager G 330.26	09/1991 - 03/1993	B 180 APC	B 180 EHD / B 160 EHD	B 185 APC	
Manager G 340ti.16,G 330.16	09/1991 - 10/1996	B 180 APC	B 180 EHD / B 160 EHD	B 185 APC	
Manager G 340ti.17,G 330.19	09/1991 - 10/1996	B 180 APC	B 180 EHD / B 160 EHD	B 185 APC	
Manager G 340ti.17/T,G 330.17/T	09/1991 - 10/1996	B 180 APC	B 180 EHD / B 160 EHD	B 185 APC	
Manager G 340ti.18,G 330.18	09/1991 - 10/1996	B 180 APC	B 180 EHD / B 160 EHD	B 185 APC	
Manager G 340ti.18/T	02/1992 - 10/1996	B 180 APC	B 180 EHD / B 160 EHD	B 185 APC	
Manager G 340ti.26,G 330.26	10/1991 - 10/1996	B 180 APC	B 180 EHD / B 160 EHD	B 185 APC	
MASCOTT Cassone / Furgonato / Promiscuo 110.35	01/1999 - 06/2004				CB 110 RST (B01)
MASCOTT Cassone / Furgonato / Promiscuo 110.50	01/1999 - 06/2004				CB 110 RST (B01)
MASCOTT Cassone / Furgonato / Promiscuo 110.55	01/1999 - 06/2004				CB 110 RST (B01)
MASCOTT Cassone / Furgonato / Promiscuo 120.35 (A02100003)	05/2004 - 10/2010				CB 110 RST (B01)
MASCOTT Cassone / Furgonato / Promiscuo 120.55 (A02300005)	05/2004 - 10/2010				CB 110 RST (B01)
MASCOTT Cassone / Furgonato / Promiscuo 130.35	01/1999 - 06/2004				CB 110 RST (B01)
MASCOTT Cassone / Furgonato / Promiscuo 130.55	01/1999 - 06/2004				CB 110 RST (B01)
MASCOTT Cassone / Furgonato / Promiscuo 140.35	01/2001 - 06/2004				CB 110 RST (B01)
MASCOTT Cassone / Furgonato / Promiscuo 140.55	01/2001 - 06/2004				CB 110 RST (B01)
MASCOTT Cassone / Furgonato / Promiscuo 150.35 (A02300161)	10/2001 - 06/2004				CB 110 RST (B01)
MASCOTT Cassone / Furgonato / Promiscuo 150.55 (A02300164)	10/2001 - 06/2004				CB 110 RST (B01)
MASCOTT Cassone / Furgonato / Promiscuo 150.65 (A00300166)	10/2001 - 06/2004				CB 110 RST (B01)
MASCOTT Cassone / Furgonato / Promiscuo 160.35 (A02100013)	05/2004 - 10/2010				CB 110 RST (B01)
MASCOTT Cassone / Furgonato / Promiscuo 160.55 (A02300015)	05/2004 - 10/2010				CB 110 RST (B01)
MASCOTT Cassone / Furgonato / Promiscuo 90.35	01/1999 - 12/2001				CB 110 RST (B01)
MASCOTT Pianale piatto/Telaio 110	01/1999 - 06/2004				CB 110 RST (B01)
MASCOTT Pianale piatto/Telaio 120.35 (A00100003, A01100003)	05/2004 - 12/2010				CB 110 RST (B01)
MASCOTT Pianale piatto/Telaio 120.55 (A00300005, A01300005)	05/2004 - 12/2010				CB 110 RST (B01)
MASCOTT Pianale piatto/Telaio 120.65 (A00500007)	05/2004 - 12/2010				CB 110 RST (B01)
MASCOTT Pianale piatto/Telaio 130	01/1999 - 06/2004				CB 110 RST (B01)
MASCOTT Pianale piatto/Telaio 140	01/2001 - 06/2004				CB 110 RST (B01)
MASCOTT Pianale piatto/Telaio 150.35 (A00300161)	10/2001 - 06/2004				CB 110 RST (B01)
MASCOTT Pianale piatto/Telaio 150.35 (A00300164)	10/2001 - 06/2004				CB 110 RST (B01)
MASCOTT Pianale piatto/Telaio 160.35 (A00100013, A01100013)	05/2004 - 12/2010				CB 110 RST (B01)
MASCOTT Pianale piatto/Telaio 160.55 (A00300015, A01300015)	05/2004 - 12/2010				CB 110 RST (B01)
MASCOTT Pianale piatto/Telaio 160.65 (A00500017, A01500017, B03200017)	05/2004 - 12/2010				CB 110 RST (B01)
MASCOTT Pianale piatto/Telaio 90	01/1999 - 12/2001				CB 110 RST (B01)
MASCOTT Ribaltabile 110	01/2000 - 06/2004				CB 110 RST (B01)
MASCOTT Ribaltabile 90	01/2000 - 06/2004				CB 110 RST (B01)
Maxity 110.28	03/2007 -				CB 110 RST (B01)
Maxity 110.32	03/2007 -				CB 110 RST (B01)
Maxity 110.35	03/2007 -				CB 110 RST (B01)

MARCHIO E MODELLO - MAKE AND MODEL MARQUE ET MODÈLE - MARKE UND MODELL MARCA Y MODELO - МАРКА И МОДЕЛЬ	Periodo Period	powerCUBE		energyCUBE	
		APC	EHD	APC	RST
RENAULT TRUCKS					
<i>cont.</i>					
Maxity 130.35	03/2007 -				CB 110 RST (B01)
Maxity 130.45	03/2007 -				CB 110 RST (B01)
Maxter G 230ti.19	10/1992 - 05/1995	B 180 APC	B 180 EHD	B 185 APC	
Maxter G 260.19	02/1996 - 06/1997	B 180 APC	B 180 EHD	B 185 APC	
Maxter G 270.19	01/1993 - 10/1996	B 180 APC	B 180 EHD	B 185 APC	
Maxter G 280.18	10/1992 - 03/1993	B 180 APC	B 180 EHD	B 185 APC	
Maxter G 280.18/T	10/1992 - 03/1993	B 180 APC	B 180 EHD	B 185 APC	
Maxter G 300.18	10/1992 - 10/1996	B 180 APC	B 180 EHD	B 185 APC	
Maxter G 300.19	02/1996 - 06/1997	B 180 APC	B 180 EHD	B 185 APC	
Maxter G 300.19	10/1992 - 10/1996	B 180 APC	B 180 EHD	B 185 APC	
Maxter G 300.19/T	10/1992 - 10/1996	B 180 APC	B 180 EHD	B 185 APC	
Maxter G 300.26	02/1996 - 06/1997	B 180 APC	B 180 EHD	B 185 APC	
Maxter G 300.26	10/1992 - 10/1996	B 180 APC	B 180 EHD	B 185 APC	
Maxter G 340ti.18/T	10/1992 - 06/1997	B 180 APC	B 180 EHD	B 185 APC	
Maxter G 340ti.19	10/1992 - 06/1997	B 180 APC	B 180 EHD	B 185 APC	
Maxter G 340ti.19/T	10/1992 - 06/1997	B 180 APC	B 180 EHD	B 185 APC	
Maxter G 340ti.25/A,G 340ti.25/B	10/1992 - 06/1997	B 180 APC	B 180 EHD	B 185 APC	
Maxter G 340ti.26	10/1992 - 06/1997	B 180 APC	B 180 EHD	B 185 APC	
Maxter G 340ti.26,G 340ti.26/B	10/1992 - 06/1997	B 180 APC	B 180 EHD	B 185 APC	
Maxter G 340ti.26/B	10/1992 - 06/1997	B 180 APC	B 180 EHD	B 185 APC	
Maxter G 340ti.26/C	10/1992 - 06/1997	B 180 APC	B 180 EHD	B 185 APC	
Maxter G 340ti.32,G 340ti.32/B	10/1992 - 06/1997	B 180 APC	B 180 EHD	B 185 APC	
Maxter G 340ti.32/A,G 340ti.32/B,G 340ti.32/C	10/1992 - 06/1997	B 180 APC	B 180 EHD	B 185 APC	
Maxter G 340ti.34	10/1992 - 06/1997	B 180 APC	B 180 EHD	B 185 APC	
Maxter G 340ti.40	10/1992 - 06/1997	B 180 APC	B 180 EHD	B 185 APC	
Midliner M 140.11/T	05/1989 - 03/1993	A 135 APC	A 140 EHD		
Midliner M 140.13/T	04/1989 - 03/1993	A 135 APC	A 140 EHD		
Midliner M 160.11/T	05/1989 - 03/1993	A 135 APC	A 140 EHD		
Midliner M 160.13/T	05/1989 - 03/1993	A 135 APC	A 140 EHD		
Midliner M 200.15/T	05/1988 - 03/1993	A 135 APC	A 140 EHD		
Midliner M 200.16/T	05/1988 - 03/1993	A 135 APC	A 140 EHD		
Midliner S 170.14/T	10/1982 - 03/1993	A 135 APC	A 140 EHD		
Midliner S 90	05/1984 - 12/1994	A 135 APC	A 140 EHD		
Midliner M M 140.12/C	05/1989 - 03/1993	A 135 APC	A 140 EHD		
Midliner M M 140.13/C	05/1989 - 03/1993	A 135 APC	A 140 EHD		
Midliner M M 150.09/C	11/1992 - 10/1996	A 135 APC	A 140 EHD		
Midliner M M 150.11/C	11/1992 - 10/1996	A 135 APC	A 140 EHD		
Midliner M M 150.12/C	05/1996 - 01/2000	A 135 APC	A 140 EHD		
Midliner M M 150.12/C	11/1992 - 10/1996	A 135 APC	A 140 EHD		
Midliner M M 150.13/C	05/1996 - 01/2000	A 135 APC	A 140 EHD		
Midliner M M 150.13/C	11/1992 - 10/1996	A 135 APC	A 140 EHD		
Midliner M M 160.12/C	05/1989 - 03/1993	A 135 APC	A 140 EHD		
Midliner M M 160.13/C	05/1989 - 03/1993	A 135 APC	A 140 EHD		
Midliner M M 180.11/C	11/1992 - 10/1996	A 135 APC	A 140 EHD		
Midliner M M 180.12/C	05/1996 - 01/2000	A 135 APC	A 140 EHD		

MARCHIO E MODELLO - MAKE AND MODEL MARQUE ET MODÈLE - MARKE UND MODELL MARCA Y MODELO - МАРКА И МОДЕЛЬ	Periodo Period	powerCUBE		energyCUBE	
		APC	EHD	APC	RST
RENAULT TRUCKS					
cont.					
Midliner M M 180.12/C	11/1992 - 10/1996	A 135 APC	A 140 EHD		
Midliner M M 180.13/C	05/1996 - 01/2000	A 135 APC	A 140 EHD		
Midliner M M 180.13/C	11/1992 - 10/1996	A 135 APC	A 140 EHD		
Midliner M M 180.15/D	10/1996 - 01/2000	A 135 APC	A 140 EHD		
Midliner M M 180.15/D	11/1992 - 10/1996	A 135 APC	A 140 EHD		
Midliner M M 180.16/D	05/1996 - 01/2000	A 135 APC	A 140 EHD		
Midliner M M 180.16/D	11/1992 - 10/1996	A 135 APC	A 140 EHD		
Midliner M M 200.10/C	05/1988 - 03/1993	A 135 APC	A 140 EHD		
Midliner M M 200.12/C	05/1988 - 03/1993	A 135 APC	A 140 EHD		
Midliner M M 200.13/C	05/1988 - 03/1993	A 135 APC	A 140 EHD		
Midliner M M 200.15/D	05/1988 - 03/1993	A 135 APC	A 140 EHD		
Midliner M M 200.16/D	05/1988 - 03/1993	A 135 APC	A 140 EHD		
Midliner M M 210.12/C	05/1992 - 01/2000	A 135 APC	A 140 EHD		
Midliner M M 210.13/C	05/1992 - 01/2000	A 135 APC	A 140 EHD		
Midliner M M 210.14/D	05/1996 - 01/2000	A 135 APC	A 140 EHD		
Midliner M M 210.15/D	05/1992 - 01/2000	A 135 APC	A 140 EHD		
Midliner M M 210.16/D	05/1992 - 01/2000	A 135 APC	A 140 EHD		
Midliner M M 210.16/D	05/1996 - 01/2000	A 135 APC	A 140 EHD		
Midliner M M 230.10/C	05/1989 - 07/1992	A 135 APC	A 140 EHD		
Midliner M M 230.12/C	05/1992 - 10/1996	A 135 APC	A 140 EHD		
Midliner M M 230.12/D	05/1989 - 07/1992	A 135 APC	A 140 EHD		
Midliner M M 230.13/C	05/1992 - 10/1996	A 135 APC	A 140 EHD		
Midliner M M 230.13/C,M 230.13/D	05/1989 - 10/1996	A 135 APC	A 140 EHD		
Midliner M M 230.13C/T	05/1989 - 10/1996	A 135 APC	A 140 EHD		
Midliner M M 230.15/D	05/1989 - 10/1996	A 135 APC	A 140 EHD		
Midliner M M 230.16/D	05/1989 - 10/1996	A 135 APC	A 140 EHD		
Midliner M M 230.16D/T	05/1989 - 10/1996	A 135 APC	A 140 EHD		
Midliner M M 250.13/C	05/1996 - 01/2000	A 135 APC	A 140 EHD		
Midliner M M 250.15/C,M 250.15/D	05/1996 - 01/2000	A 135 APC	A 140 EHD		
Midliner M M 250.15C/T	05/1996 - 01/2000	A 135 APC	A 140 EHD		
Midliner M M 250.16/D	05/1996 - 01/2000	A 135 APC	A 140 EHD		
Midliner M ME 160.13	05/1989 - 03/1993	A 135 APC	A 140 EHD		
Midliner M ME 160.15	05/1989 - 03/1993	A 135 APC	A 140 EHD		
Midliner M ME 180.15	05/1989 - 03/1993	A 135 APC	A 140 EHD		
Midliner S S 100.07/A	01/1986 - 09/1990	A 135 APC	A 140 EHD		
Midliner S S 100.08/A	01/1986 - 09/1990	A 135 APC	A 140 EHD		
Midliner S S 110.08/A	06/1985 - 09/1990	A 135 APC	A 140 EHD		
Midliner S S 120.06/A	09/1990 - 11/1992	A 135 APC	A 140 EHD		
Midliner S S 120.06/A,S 120.07/A	09/1990 - 11/1992	A 135 APC	A 140 EHD		
Midliner S S 120.06/A,S 120.07/A	11/1992 - 10/1994	A 135 APC	A 140 EHD		
Midliner S S 120.07/A	09/1990 - 11/1992	A 135 APC	A 140 EHD		
Midliner S S 120.07/A	11/1992 - 10/1994	A 135 APC	A 140 EHD		
Midliner S S 120.08/A	09/1990 - 11/1992	A 135 APC	A 140 EHD		
Midliner S S 120.08/A	11/1992 - 10/1994	A 135 APC	A 140 EHD		
Midliner S S 130.08/A,S 130.08/B	09/1983 - 01/1990	A 135 APC	A 140 EHD		

MARCHIO E MODELLO - MAKE AND MODEL MARQUE ET MODÈLE - MARKE UND MODELL MARCA Y MODELO - МАРКА И МОДЕЛЬ	Periodo Period	powerCUBE		energyCUBE	
		APC	EHD	APC	RST
RENAULT TRUCKS					
<i>cont.</i>					
Midliner S S 130.09/B	09/1983 - 01/1990	A 135 APC	A 140 EHD		
Midliner S S 135.08/A	02/1994 - 05/1996	A 135 APC	A 140 EHD		
Midliner S S 135.08/A,S 150.08/A	05/1996 - 01/2000	A 135 APC	A 140 EHD		
Midliner S S 140.07/A	01/1990 - 09/1993	A 135 APC	A 140 EHD		
Midliner S S 140.08/A,S 140.08/B	01/1990 - 09/1993	A 135 APC	A 140 EHD		
Midliner S S 140.09/B	01/1990 - 09/1993	A 135 APC	A 140 EHD		
Midliner S S 150.08/A,S 150.08/B	01/1994 - 05/1996	A 135 APC	A 140 EHD		
Midliner S S 150.08/A,S 150.08/B	11/1992 - 01/1994	A 135 APC	A 140 EHD		
Midliner S S 150.08/B	01/1994 - 05/1996	A 135 APC	A 140 EHD		
Midliner S S 150.08/B	11/1992 - 01/1994	A 135 APC	A 140 EHD		
Midliner S S 150.08TI	05/1983 - 07/1986	A 135 APC	A 140 EHD		
Midliner S S 150.08TI	05/1986 - 09/1990	A 135 APC	A 140 EHD		
Midliner S S 150.09/B	01/1994 - 05/1996	A 135 APC	A 140 EHD		
Midliner S S 150.09/B	11/1992 - 01/1994	A 135 APC	A 140 EHD		
Midliner S S 150.09/B,S 135.09/B	05/1996 - 01/2000	A 135 APC	A 140 EHD		
Midliner S S 150.09TI	05/1983 - 07/1986	A 135 APC	A 140 EHD		
Midliner S S 150.09TI	05/1986 - 09/1990	A 135 APC	A 140 EHD		
Midliner S S 150.11TI	05/1986 - 09/1990	A 135 APC	A 140 EHD		
Midliner S S 150.13TI	05/1986 - 09/1990	A 135 APC	A 140 EHD		
Midliner S S 160.08/A,S 160.08/B	01/1990 - 09/1993	A 135 APC	A 140 EHD		
Midliner S S 160.09/B	01/1990 - 09/1993	A 135 APC	A 140 EHD		
Midliner S S 170.11TI	10/1987 - 05/1989	A 135 APC	A 140 EHD		
Midliner S S 170.13TI,S 170.13TI/R	10/1983 - 05/1989	A 135 APC	A 140 EHD		
Midliner S S 170.13TI/T	10/1984 - 05/1989	A 135 APC	A 140 EHD		
Midliner S S 170.14TI	10/1983 - 05/1989	A 135 APC	A 140 EHD		
Midliner S S 180.08/A	05/1996 - 01/2000	A 135 APC	A 140 EHD		
Midliner S S 180.08/A,S 180.08/B	11/1992 - 10/1996	A 135 APC	A 140 EHD		
Midliner S S 180.09/B	05/1996 - 01/2000	A 135 APC	A 140 EHD		
Midliner S S 180.09/B	11/1992 - 10/1996	A 135 APC	A 140 EHD		
Midliner S S 210.08/A	04/1995 - 01/2000	A 135 APC	A 140 EHD		
Midliner S S 210.09/B	04/1995 - 01/2000	A 135 APC	A 140 EHD		
Midliner S S 220.13TI	09/1987 - 09/1990	A 135 APC	A 140 EHD		
Midliner S S 220.13TI/T	09/1987 - 09/1990	A 135 APC	A 140 EHD		
Midliner S S 220.14TI	09/1987 - 09/1990	A 135 APC	A 140 EHD		
Midliner S S 220.14TI/T	09/1987 - 09/1990	A 135 APC	A 140 EHD		
Midlum 135.08/B,150.08/B	01/2000 -	A 135 APC	A 140 EHD		
Midlum 135.09/B,150.09/B	01/2000 -	A 135 APC	A 140 EHD		
Midlum 135.10/B,150.10/B	01/2000 -	A 135 APC	A 140 EHD		
Midlum 150.08/B	10/2001 -	A 135 APC	A 140 EHD		
Midlum 150.10/B	10/2001 -	A 135 APC	A 140 EHD		
Midlum 150.12/B	01/2000 -	A 135 APC	A 140 EHD		
Midlum 160.08	05/2006 -	B 180 APC	B 180 EHD / B 160 EHD	B 185 APC	
Midlum 160.10	05/2006 -	B 180 APC	B 180 EHD / B 160 EHD	B 185 APC	
Midlum 160.12	05/2006 -	B 180 APC	B 180 EHD / B 160 EHD	B 185 APC	
Midlum 180	10/2001 -	B 180 APC	B 180 EHD / B 160 EHD	B 185 APC	

MARCHIO E MODELLO - MAKE AND MODEL MARQUE ET MODÈLE - MARKE UND MODELL MARCA Y MODELO - МАРКА И МОДЕЛЬ	Periodo Period	powerCUBE		energyCUBE	
		APC	EHD	APC	RST
RENAULT TRUCKS					
<small>cont.</small>					
Midlum 180.08/B	01/2000 -	B 180 APC	B 180 EHD / B 160 EHD	B 185 APC	
Midlum 180.08/B	10/2001 -	B 180 APC	B 180 EHD / B 160 EHD	B 185 APC	
Midlum 180.09/B	01/2000 -	B 180 APC	B 180 EHD / B 160 EHD	B 185 APC	
Midlum 180.10/B	01/2000 -	B 180 APC	B 180 EHD / B 160 EHD	B 185 APC	
Midlum 180.10/B	10/2001 -	B 180 APC	B 180 EHD / B 160 EHD	B 185 APC	
Midlum 180.12	10/2001 -	B 180 APC	B 180 EHD / B 160 EHD	B 185 APC	
Midlum 180.12/B	01/2000 -	B 180 APC	B 180 EHD / B 160 EHD	B 185 APC	
Midlum 190.08	05/2006 -	B 180 APC	B 180 EHD / B 160 EHD	B 185 APC	
Midlum 190.10	05/2006 -	B 180 APC	B 180 EHD / B 160 EHD	B 185 APC	
Midlum 190.12	05/2006 -	B 180 APC	B 180 EHD / B 160 EHD	B 185 APC	
Midlum 190.13	05/2006 -	B 180 APC	B 180 EHD / B 160 EHD	B 185 APC	
Midlum 190.14	05/2006 -	B 180 APC	B 180 EHD / B 160 EHD	B 185 APC	
Midlum 190.16	05/2006 -	B 180 APC	B 180 EHD / B 160 EHD	B 185 APC	
Midlum 210.08/B	01/2000 -	B 180 APC	B 180 EHD / B 160 EHD	B 185 APC	
Midlum 210.09/B	01/2000 -	B 180 APC	B 180 EHD / B 160 EHD	B 185 APC	
Midlum 210.10/B	01/2000 -	B 180 APC	B 180 EHD / B 160 EHD	B 185 APC	
Midlum 210.12/C	01/2000 -	B 180 APC	B 180 EHD / B 160 EHD	B 185 APC	
Midlum 210.13/C	01/2000 -	B 180 APC	B 180 EHD / B 160 EHD	B 185 APC	
Midlum 210.14/C	01/2000 -	B 180 APC	B 180 EHD / B 160 EHD	B 185 APC	
Midlum 210.15/C	01/2000 -	B 180 APC	B 180 EHD / B 160 EHD	B 185 APC	
Midlum 210.16/C	01/2000 -	B 180 APC	B 180 EHD / B 160 EHD	B 185 APC	
Midlum 220.08	05/2006 -	B 180 APC	B 180 EHD / B 160 EHD	B 185 APC	
Midlum 220.10	05/2006 -	B 180 APC	B 180 EHD / B 160 EHD	B 185 APC	
Midlum 220.12	05/2006 -	B 180 APC	B 180 EHD / B 160 EHD	B 185 APC	
Midlum 220.12	10/2001 -	B 180 APC	B 180 EHD / B 160 EHD	B 185 APC	
Midlum 220.13	05/2006 -	B 180 APC	B 180 EHD / B 160 EHD	B 185 APC	
Midlum 220.14	05/2006 -	B 180 APC	B 180 EHD / B 160 EHD	B 185 APC	
Midlum 220.14	10/2001 -	B 180 APC	B 180 EHD / B 160 EHD	B 185 APC	
Midlum 220.15	10/2001 -	B 180 APC	B 180 EHD / B 160 EHD	B 185 APC	
Midlum 220.16	05/2006 -	B 180 APC	B 180 EHD / B 160 EHD	B 185 APC	
Midlum 220.18/D	10/2001 -	B 180 APC	B 180 EHD / B 160 EHD	B 185 APC	
Midlum 240.12	05/2006 -	B 180 APC	B 180 EHD / B 160 EHD	B 185 APC	
Midlum 240.13	05/2006 -	B 180 APC	B 180 EHD / B 160 EHD	B 185 APC	
Midlum 240.14	05/2006 -	B 180 APC	B 180 EHD / B 160 EHD	B 185 APC	
Midlum 240.15	05/2006 -	B 180 APC	B 180 EHD / B 160 EHD	B 185 APC	
Midlum 240.16	05/2006 -	B 180 APC	B 180 EHD / B 160 EHD	B 185 APC	
Midlum 240.18	05/2006 -	B 180 APC	B 180 EHD / B 160 EHD	B 185 APC	
Midlum 250.12/C	01/2000 -	B 180 APC	B 180 EHD / B 160 EHD	B 185 APC	
Midlum 250.13/C	01/2000 -	B 180 APC	B 180 EHD / B 160 EHD	B 185 APC	
Midlum 250.14/C	01/2000 -	B 180 APC	B 180 EHD / B 160 EHD	B 185 APC	
Midlum 250.15/C	01/2000 -	B 180 APC	B 180 EHD / B 160 EHD	B 185 APC	
Midlum 250.16/C	01/2000 -	B 180 APC	B 180 EHD / B 160 EHD	B 185 APC	
Midlum 250.16/CT	01/2000 -	B 180 APC	B 180 EHD / B 160 EHD	B 185 APC	
Midlum 270.12/C	10/2001 -	B 180 APC	B 180 EHD / B 160 EHD	B 185 APC	
Midlum 270.13/C	10/2001 -	B 180 APC	B 180 EHD / B 160 EHD	B 185 APC	

MARCHIO E MODELLO - MAKE AND MODEL MARQUE ET MODÈLE - MARKE UND MODELL MARCA Y MODELO - МАРКА И МОДЕЛЬ	Periodo Period	powerCUBE		energyCUBE	
		APC	EHD	APC	RST
RENAULT TRUCKS <i>cont.</i>					
Midlum 270.14/C	10/2001 -	B 180 APC	B 180 EHD / B 160 EHD	B 185 APC	
Midlum 270.16/C	10/2001 -	B 180 APC	B 180 EHD / B 160 EHD	B 185 APC	
Midlum 280.12	05/2006 -	B 180 APC	B 180 EHD / B 160 EHD	B 185 APC	
Midlum 280.13	05/2006 -	B 180 APC	B 180 EHD / B 160 EHD	B 185 APC	
Midlum 280.14	05/2006 -	B 180 APC	B 180 EHD / B 160 EHD	B 185 APC	
Midlum 280.16	05/2006 -	B 180 APC	B 180 EHD / B 160 EHD	B 185 APC	
Midlum 280.18	05/2006 -	B 180 APC	B 180 EHD / B 160 EHD	B 185 APC	
PR 100	01/1987 - 12/1990	B 180 APC	B 180 EHD	B 185 APC	
PR 180	01/1987 - 12/1989	B 180 APC	B 180 EHD	B 185 APC	
Premium 2 Distribution 240.18 D	05/2006 -	B 180 APC	B 180 EHD / B 160 EHD	B 185 APC	
Premium 2 Distribution 270.19	10/2006 -	B 180 APC	B 180 EHD / B 160 EHD	B 185 APC	
Premium 2 Distribution 280.18 D	10/2005 -	B 180 APC	B 180 EHD / B 160 EHD	B 185 APC	
Premium 2 Distribution 280.26	10/2005 -	B 180 APC	B 180 EHD / B 160 EHD	B 185 APC	
Premium 2 Distribution 310.18	10/2006 -	B 180 APC	B 180 EHD / B 160 EHD	B 185 APC	
Premium 2 Distribution 310.26	10/2006 -	B 180 APC	B 180 EHD / B 160 EHD	B 185 APC	
Premium 2 Distribution 320.18	05/2006 -	B 180 APC	B 180 EHD / B 160 EHD	B 185 APC	
Premium 2 Distribution 320.18 D	10/2005 -	B 180 APC	B 180 EHD / B 160 EHD	B 185 APC	
Premium 2 Distribution 320.26	10/2005 -	B 180 APC	B 180 EHD / B 160 EHD	B 185 APC	
Premium 2 Distribution 340.18	10/2006 -	B 180 APC	B 180 EHD / B 160 EHD	B 185 APC	
Premium 2 Distribution 340.19	10/2006 -	B 180 APC	B 180 EHD / B 160 EHD	B 185 APC	
Premium 2 Distribution 340.26	10/2006 -	B 180 APC	B 180 EHD / B 160 EHD	B 185 APC	
Premium 2 Distribution 370.18 D	10/2005 -	B 180 APC	B 180 EHD / B 160 EHD	B 185 APC	
Premium 2 Distribution 370.26	10/2005 -	B 180 APC	B 180 EHD / B 160 EHD	B 185 APC	
Premium 2 Distribution 380.18	10/2006 -	B 180 APC	B 180 EHD / B 160 EHD	B 185 APC	
Premium 2 Distribution 380.19	10/2006 -	B 180 APC	B 180 EHD / B 160 EHD	B 185 APC	
Premium 2 Distribution 380.26	10/2006 -	B 180 APC	B 180 EHD / B 160 EHD	B 185 APC	
Premium 2 Distribution 410.18 D	10/2005 -	B 180 APC	B 180 EHD / B 160 EHD	B 185 APC	
Premium 2 Distribution 410.26	10/2005 -	B 180 APC	B 180 EHD / B 160 EHD	B 185 APC	
Premium 2 Distribution 430.18	10/2006 -	B 180 APC	B 180 EHD / B 160 EHD	B 185 APC	
Premium 2 Distribution 430.19	10/2006 -	B 180 APC	B 180 EHD / B 160 EHD	B 185 APC	
Premium 2 Distribution 430.26	10/2006 -	B 180 APC	B 180 EHD / B 160 EHD	B 185 APC	
Premium 2 Distribution 450.18 D	10/2005 -	B 180 APC	B 180 EHD / B 160 EHD	B 185 APC	
Premium 2 Distribution 460.19	10/2006 -	B 180 APC	B 180 EHD / B 160 EHD	B 185 APC	
Premium 2 Lander 270.18, Lander 270.19	10/2006 -	B 180 APC	B 180 EHD / B 160 EHD	B 185 APC	
Premium 2 Lander 310.19	10/2006 -	B 180 APC	B 180 EHD / B 160 EHD	B 185 APC	
Premium 2 Lander 310.26	10/2006 -	B 180 APC	B 180 EHD / B 160 EHD	B 185 APC	
Premium 2 Lander 340.18, Lander 340.19	10/2006 -	B 180 APC	B 180 EHD / B 160 EHD	B 185 APC	
Premium 2 Lander 340.26	10/2006 -	B 180 APC	B 180 EHD / B 160 EHD	B 185 APC	
Premium 2 Lander 380.19	10/2006 -	B 180 APC	B 180 EHD / B 160 EHD	B 185 APC	
Premium 2 Lander 380.26	10/2006 -	B 180 APC	B 180 EHD / B 160 EHD	B 185 APC	
Premium 2 Lander 380.32	10/2006 -	B 180 APC	B 180 EHD / B 160 EHD	B 185 APC	
Premium 2 Lander 430.18	10/2006 -	B 180 APC	B 180 EHD / B 160 EHD	B 185 APC	
Premium 2 Lander 430.26	10/2006 -	B 180 APC	B 180 EHD / B 160 EHD	B 185 APC	
Premium 2 Lander 430.32	10/2006 -	B 180 APC	B 180 EHD / B 160 EHD	B 185 APC	
Premium 2 Lander 440.18		B 180 APC	B 180 EHD / B 160 EHD	B 185 APC	

MARCHIO E MODELLO - MAKE AND MODEL MARQUE ET MODÈLE - MARKE UND MODELL MARCA Y MODELO - МАРКА И МОДЕЛЬ	Periodo Period	powerCUBE		energyCUBE	
		APC	EHD	APC	RST
RENAULT TRUCKS cont.					
Premium 2 Lander 440.19		B 180 APC	B 180 EHD / B 160 EHD	B 185 APC	
Premium 2 Lander 440.26		B 180 APC	B 180 EHD / B 160 EHD	B 185 APC	
Premium 2 Lander 440.32		B 180 APC	B 180 EHD / B 160 EHD	B 185 APC	
Premium 2 Lander 460.18	10/2006 -	B 180 APC	B 180 EHD / B 160 EHD	B 185 APC	
Premium 2 Lander 460.26	10/2006 -	B 180 APC	B 180 EHD / B 160 EHD	B 185 APC	
Premium 2 Lander 460.32	10/2006 -	B 180 APC	B 180 EHD / B 160 EHD	B 185 APC	
Premium 2 Route 330.18 T	10/2005 -	B 180 APC	B 180 EHD / B 160 EHD	B 185 APC	
Premium 2 Route 380.18	10/2006 -	B 180 APC	B 180 EHD / B 160 EHD	B 185 APC	
Premium 2 Route 380.19	10/2006 -	B 180 APC	B 180 EHD / B 160 EHD	B 185 APC	
Premium 2 Route 380.26	10/2006 -	B 180 APC	B 180 EHD / B 160 EHD	B 185 APC	
Premium 2 Route 410.18	10/2005 -	B 180 APC	B 180 EHD / B 160 EHD	B 185 APC	
Premium 2 Route 410.18 D	10/2005 -	B 180 APC	B 180 EHD / B 160 EHD	B 185 APC	
Premium 2 Route 410.24	10/2005 -	B 180 APC	B 180 EHD / B 160 EHD	B 185 APC	
Premium 2 Route 410.25	10/2005 -	B 180 APC	B 180 EHD / B 160 EHD	B 185 APC	
Premium 2 Route 410.26	10/2005 -	B 180 APC	B 180 EHD / B 160 EHD	B 185 APC	
Premium 2 Route 430.18	10/2006 -	B 180 APC	B 180 EHD / B 160 EHD	B 185 APC	
Premium 2 Route 430.19	10/2006 -	B 180 APC	B 180 EHD / B 160 EHD	B 185 APC	
Premium 2 Route 430.26	10/2006 -	B 180 APC	B 180 EHD / B 160 EHD	B 185 APC	
Premium 2 Route 450.18	10/2005 -	B 180 APC	B 180 EHD / B 160 EHD	B 185 APC	
Premium 2 Route 450.18 D	10/2005 -	B 180 APC	B 180 EHD / B 160 EHD	B 185 APC	
Premium 2 Route 450.24	10/2005 -	B 180 APC	B 180 EHD / B 160 EHD	B 185 APC	
Premium 2 Route 450.25	10/2005 -	B 180 APC	B 180 EHD / B 160 EHD	B 185 APC	
Premium 2 Route 450.26	10/2005 -	B 180 APC	B 180 EHD / B 160 EHD	B 185 APC	
Premium 2 Route 460.18	10/2006 -	B 180 APC	B 180 EHD / B 160 EHD	B 185 APC	
Premium 2 Route 460.26	10/2006 -	B 180 APC	B 180 EHD / B 160 EHD	B 185 APC	
Premium Distribution 210.18D, 220.18	04/1996 -	B 180 APC	B 180 EHD / B 160 EHD	B 185 APC	
Premium Distribution 250.18D	04/1996 -	B 180 APC	B 180 EHD / B 160 EHD	B 185 APC	
Premium Distribution 270.18	08/2000 -	B 180 APC	B 180 EHD / B 160 EHD	B 185 APC	
Premium Distribution 300.18D	04/1996 -	B 180 APC	B 180 EHD / B 160 EHD	B 185 APC	
Premium Distribution 300.18D/T	04/1996 -	B 180 APC	B 180 EHD / B 160 EHD	B 185 APC	
Premium Distribution 300.26D	04/1996 -	B 180 APC	B 180 EHD / B 160 EHD	B 185 APC	
Premium Distribution 320.18	08/2000 -	B 180 APC	B 180 EHD / B 160 EHD	B 185 APC	
Premium Distribution 320.18 D	08/2000 -	B 180 APC	B 180 EHD / B 160 EHD	B 185 APC	
Premium Distribution 320.24D	08/2000 -	B 180 APC	B 180 EHD / B 160 EHD	B 185 APC	
Premium Distribution 320.26D	08/2000 -	B 180 APC	B 180 EHD / B 160 EHD	B 185 APC	
Premium Distribution 340.18D	04/1996 -	B 180 APC	B 180 EHD / B 160 EHD	B 185 APC	
Premium Distribution 340.18D/T	04/1996 -	B 180 APC	B 180 EHD / B 160 EHD	B 185 APC	
Premium Distribution 340.26D	04/1996 -	B 180 APC	B 180 EHD / B 160 EHD	B 185 APC	
Premium Distribution 370.18	08/2000 -	B 180 APC	B 180 EHD / B 160 EHD	B 185 APC	
Premium Distribution 370.18D	08/2000 -	B 180 APC	B 180 EHD / B 160 EHD	B 185 APC	
Premium Distribution 370.24D	08/2000 -	B 180 APC	B 180 EHD / B 160 EHD	B 185 APC	
Premium Distribution 370.26D	08/2000 -	B 180 APC	B 180 EHD / B 160 EHD	B 185 APC	
Premium Distribution 400.18D	01/2000 -	B 180 APC	B 180 EHD / B 160 EHD	B 185 APC	
Premium Distribution 400.18D/T	01/2000 -	B 180 APC	B 180 EHD / B 160 EHD	B 185 APC	
Premium Distribution 420.18	08/2000 -	B 180 APC	B 180 EHD / B 160 EHD	B 185 APC	

MARCHIO E MODELLO - MAKE AND MODEL MARQUE ET MODÈLE - MARKE UND MODELL MARCA Y MODELO - МАРКА И МОДЕЛЬ	Periodo Period	powerCUBE		energyCUBE	
		APC	EHD	APC	RST
RENAULT TRUCKS <i>cont.</i>					
Premium Distribution 420.18D	08/2000 -	B 180 APC	B 180 EHD / B 160 EHD	B 185 APC	
Premium Route 300.18	09/1996 -	B 180 APC	B 180 EHD / B 160 EHD	B 185 APC	
Premium Route 300.18T	09/1996 -	B 180 APC	B 180 EHD / B 160 EHD	B 185 APC	
Premium Route 320.18	08/2000 -	B 180 APC	B 180 EHD / B 160 EHD	B 185 APC	
Premium Route 340.18	04/1996 -	B 180 APC	B 180 EHD / B 160 EHD	B 185 APC	
Premium Route 340.18T	04/1996 -	B 180 APC	B 180 EHD / B 160 EHD	B 185 APC	
Premium Route 340.26	04/1996 -	B 180 APC	B 180 EHD / B 160 EHD	B 185 APC	
Premium Route 370.18	08/2000 -	B 180 APC	B 180 EHD / B 160 EHD	B 185 APC	
Premium Route 370.24	08/2000 -	B 180 APC	B 180 EHD / B 160 EHD	B 185 APC	
Premium Route 370.26	08/2000 -	B 180 APC	B 180 EHD / B 160 EHD	B 185 APC	
Premium Route 385.18,400.18	04/1996 -	B 180 APC	B 180 EHD / B 160 EHD	B 185 APC	
Premium Route 385.18T,400.18T	04/1996 -	B 180 APC	B 180 EHD / B 160 EHD	B 185 APC	
Premium Route 385.24,400.24	04/1996 -	B 180 APC	B 180 EHD / B 160 EHD	B 185 APC	
Premium Route 385.24T,400.24T	09/1996 -	B 180 APC	B 180 EHD / B 160 EHD	B 185 APC	
Premium Route 385.26	04/1996 -	B 180 APC	B 180 EHD / B 160 EHD	B 185 APC	
Premium Route 385.26,400.26	04/1996 -	B 180 APC	B 180 EHD / B 160 EHD	B 185 APC	
Premium Route 420.18	08/2000 -	B 180 APC	B 180 EHD / B 160 EHD	B 185 APC	
Premium Route 420.18T	08/2000 -	B 180 APC	B 180 EHD / B 160 EHD	B 185 APC	
Premium Route 420.24	08/2000 -	B 180 APC	B 180 EHD / B 160 EHD	B 185 APC	
Premium Route 420.25	08/2000 -	B 180 APC	B 180 EHD / B 160 EHD	B 185 APC	
Premium Route 420.26	08/2000 -	B 180 APC	B 180 EHD / B 160 EHD	B 185 APC	
R 312	01/1987 -	B 180 APC	B 180 EHD	B 185 APC	
R R 310.16	10/1980 - 03/1989	B 180 APC	B 180 EHD	B 185 APC	
R R 310.16/T	10/1980 - 03/1989	B 180 APC	B 180 EHD	B 185 APC	
R R 310.17	10/1980 - 03/1989	B 180 APC	B 180 EHD	B 185 APC	
R R 310.17/T	10/1980 - 03/1989	B 180 APC	B 180 EHD	B 185 APC	
R R 310.22	10/1980 - 03/1989	B 180 APC	B 180 EHD	B 185 APC	
R R 310.22/T	10/1980 - 03/1989	B 180 APC	B 180 EHD	B 185 APC	
R R 330.17	05/1988 - 05/1991	B 180 APC	B 180 EHD	B 185 APC	
R R 330.17/T	05/1988 - 05/1991	B 180 APC	B 180 EHD	B 185 APC	
R R 330.24	05/1988 - 05/1991	B 180 APC	B 180 EHD	B 185 APC	
R R 340.17	03/1986 - 01/1990	B 180 APC	B 180 EHD	B 185 APC	
R R 340.17/T	03/1986 - 01/1990	B 180 APC	B 180 EHD	B 185 APC	
R R 340.24	03/1986 - 01/1990	B 180 APC	B 180 EHD	B 185 APC	
R R 340ti.16/T	01/1990 - 05/1991	B 180 APC	B 180 EHD	B 185 APC	
R R 340ti.17	01/1990 - 05/1991	B 180 APC	B 180 EHD	B 185 APC	
R R 340ti.18	01/1990 - 05/1991	B 180 APC	B 180 EHD	B 185 APC	
R R 340ti.18/T	01/1990 - 05/1991	B 180 APC	B 180 EHD	B 185 APC	
R R 340ti.24	01/1990 - 05/1991	B 180 APC	B 180 EHD	B 185 APC	
R R 340ti.26	01/1990 - 05/1991	B 180 APC	B 180 EHD	B 185 APC	
R R 350.17	01/1990 - 05/1991	B 180 APC	B 180 EHD	B 185 APC	
R R 350.17/T	01/1990 - 05/1991	B 180 APC	B 180 EHD	B 185 APC	
R R 350.18	01/1990 - 05/1991	B 180 APC	B 180 EHD	B 185 APC	
R R 350.18/T	01/1990 - 05/1991	B 180 APC	B 180 EHD	B 185 APC	
R R 350.24	01/1990 - 05/1991	B 180 APC	B 180 EHD	B 185 APC	

MARCHIO E MODELLO - <i>MAKE AND MODEL</i> MARQUE ET MODÈLE - <i>MARKE UND MODELL</i> MARCA Y MODELO - <i>МАРКА И МОДЕЛЬ</i>	Periodo <i>Period</i>	powerCUBE		energyCUBE	
		APC	EHD	APC	RST
RENAULT TRUCKS <small>cont.</small>					
RR 350.26	01/1990 - 05/1991	B 180 APC	B 180 EHD	B 185 APC	
RR 360.19/T	01/1990 - 05/1991	B 180 APC	B 180 EHD	B 185 APC	
RR 360.26/T	01/1990 - 05/1991	B 180 APC	B 180 EHD	B 185 APC	
RR 365.17	10/1987 - 05/1990	B 180 APC	B 180 EHD / B 160 EHD	B 185 APC	
RR 365.17/T	10/1987 - 05/1990	B 180 APC	B 180 EHD / B 160 EHD	B 185 APC	
RR 365.24	10/1987 - 05/1990	B 180 APC	B 180 EHD / B 160 EHD	B 185 APC	
RR 370.16	10/1983 - 07/1985	B 180 APC	B 180 EHD / B 160 EHD	B 185 APC	
RR 370.16/T	10/1983 - 07/1985	B 180 APC	B 180 EHD / B 160 EHD	B 185 APC	
RR 370.19/T	10/1983 - 07/1985	B 180 APC	B 180 EHD	B 185 APC	
RR 370.22/T	10/1983 - 07/1985	B 180 APC	B 180 EHD / B 160 EHD	B 185 APC	
RR 370.26/T	10/1983 - 07/1985	B 180 APC	B 180 EHD	B 185 APC	
RR 380.18	01/1990 - 05/1991	B 180 APC	B 180 EHD / B 160 EHD	B 185 APC	
RR 380.18/T	01/1990 - 05/1991	B 180 APC	B 180 EHD / B 160 EHD	B 185 APC	
RR 380.24	01/1990 - 05/1991	B 180 APC	B 180 EHD / B 160 EHD	B 185 APC	
RR 380.25	01/1990 - 05/1991	B 180 APC	B 180 EHD / B 160 EHD	B 185 APC	
RR 380.25/T	01/1990 - 05/1991	B 180 APC	B 180 EHD / B 160 EHD	B 185 APC	
RR 380.26	01/1990 - 05/1991	B 180 APC	B 180 EHD / B 160 EHD	B 185 APC	
RR 380.26/T	01/1990 - 05/1991	B 180 APC	B 180 EHD / B 160 EHD	B 185 APC	
RR 390.16	07/1985 - 03/1989	B 180 APC	B 180 EHD / B 160 EHD	B 185 APC	
RR 390.16/T	07/1985 - 03/1989	B 180 APC	B 180 EHD / B 160 EHD	B 185 APC	
RR 390.17	07/1985 - 03/1989	B 180 APC	B 180 EHD / B 160 EHD	B 185 APC	
RR 390.17/T	07/1985 - 03/1989	B 180 APC	B 180 EHD / B 160 EHD	B 185 APC	
RR 390.19/T	07/1985 - 03/1989	B 180 APC	B 180 EHD	B 185 APC	
RR 390.22/T	07/1985 - 03/1989	B 180 APC	B 180 EHD / B 160 EHD	B 185 APC	
RR 390.24	07/1985 - 03/1989	B 180 APC	B 180 EHD / B 160 EHD	B 185 APC	
RR 390.24/T	07/1985 - 03/1989	B 180 APC	B 180 EHD / B 160 EHD	B 185 APC	
RR 420.17	10/1988 - 10/1991	B 180 APC	B 180 EHD / B 160 EHD	B 185 APC	
RR 420.17/T	10/1988 - 10/1991	B 180 APC	B 180 EHD / B 160 EHD	B 185 APC	
RR 420.24	10/1988 - 10/1991	B 180 APC	B 180 EHD / B 160 EHD	B 185 APC	
RR 420.24/T	10/1988 - 10/1991	B 180 APC	B 180 EHD / B 160 EHD	B 185 APC	
RR 420.35/T	10/1988 - 10/1991	B 180 APC	B 180 EHD / B 160 EHD	B 185 APC	
TB TB 191/T	06/1980 -	B 180 APC	B 180 EHD	B 185 APC	
TB TB 231/T	06/1980 -	B 180 APC	B 180 EHD	B 185 APC	
TBH TBH 280	01/1977 - 06/1980	B 180 APC	B 180 EHD	B 185 APC	
TR TR 280	05/1971 - 12/1974	B 180 APC	B 180 EHD	B 185 APC	
TR TR 280/T	05/1971 - 12/1974	B 180 APC	B 180 EHD	B 185 APC	
TR TR 350	08/1977 - 12/1981	B 180 APC	B 180 EHD	B 185 APC	
TR TR 350/T	08/1977 - 12/1981	B 180 APC	B 180 EHD	B 185 APC	
Tracer Tracer	01/1991 -	B 180 APC	B 180 EHD	B 185 APC	
TRH TRH 350	08/1977 - 06/1980	B 180 APC	B 180 EHD	B 185 APC	
TRH TRH 350/T	08/1977 - 06/1980	B 180 APC	B 180 EHD	B 185 APC	
T-Serie 380P LOW	01/2013 -	B 180 APC		B 185 APC	
T-Serie 380P, 380P LOW	01/2013 -	B 180 APC		B 185 APC	
T-Serie 380T LOW, 380T TAG	01/2013 -	B 180 APC		B 185 APC	
T-Serie 380T PUS	01/2013 -	B 180 APC		B 185 APC	

MARCHIO E MODELLO - MAKE AND MODEL MARQUE ET MODÈLE - MARKE UND MODELL MARCA Y MODELO - МАРКА И МОДЕЛЬ	Periodo Period	powerCUBE		energyCUBE	
		APC	EHD	APC	RST
RENAULT TRUCKS					
<i>cont.</i>					
T-Serie 380T, 380T LOW, 380T X-LOW	01/2013 -	B 180 APC		B 185 APC	
T-Serie 430P LOW	01/2013 -	B 180 APC		B 185 APC	
T-Serie 430P, 430P LOW	01/2013 -	B 180 APC		B 185 APC	
T-Serie 430T PUS	01/2013 -	B 180 APC		B 185 APC	
T-Serie 430T TAG, 430T LOW	01/2013 -	B 180 APC		B 185 APC	
T-Serie 430T, 430T LOW, 430T X-LOW	01/2013 -	B 180 APC		B 185 APC	
T-Serie 440P LOW	01/2013 -	B 180 APC		B 185 APC	
T-Serie 440P, 440P LOW	01/2013 -	B 180 APC		B 185 APC	
T-Serie 440T LOW, 440T TAG	01/2013 -	B 180 APC		B 185 APC	
T-Serie 440T PUS	01/2013 -	B 180 APC		B 185 APC	
T-Serie 440T, 440T LOW, 440T X-LOW	01/2013 -	B 180 APC		B 185 APC	
T-Serie 460P LOW	01/2013 -	B 180 APC		B 185 APC	
T-Serie 460P, 460P LOW	01/2013 -	B 180 APC		B 185 APC	
T-Serie 460T LOW, 460T TAG	01/2013 -	B 180 APC		B 185 APC	
T-Serie 460T PUS	01/2013 -	B 180 APC		B 185 APC	
T-Serie 460T, 460T LOW, 460T X-LOW	01/2013 -	B 180 APC		B 185 APC	
T-Serie 480P LOW	01/2013 -	B 180 APC		B 185 APC	
T-Serie 480P, 480P LOW	01/2013 -	B 180 APC		B 185 APC	
T-Serie 480T LOW, 480T TAG	01/2013 -	B 180 APC		B 185 APC	
T-Serie 480T PUS	01/2013 -	B 180 APC		B 185 APC	
T-Serie 480T, 480T LOW, 480T X-LOW	01/2013 -	B 180 APC		B 185 APC	
T-Serie 520P LOW	01/2013 -	B 180 APC		B 185 APC	
T-Serie 520P, 520P LOW	01/2013 -	B 180 APC		B 185 APC	
T-Serie 520T LOW, 520T TAG	01/2013 -	B 180 APC		B 185 APC	
T-Serie 520T PUS	01/2013 -	B 180 APC		B 185 APC	
T-Serie 520T, 520T LOW, 520T X-LOW	01/2013 -	B 180 APC		B 185 APC	
SCANIA					
112 H 112 H/280	01/1981 - 12/1986	A 135 APC	A 140 EHD / A 120 EHD		
112 H 112 H/305	01/1981 - 12/1986	A 135 APC	A 140 EHD / A 120 EHD		
112 M 112 M/305	01/1981 - 12/1986	A 135 APC	A 140 EHD / A 120 EHD		
113 E 113 E/320	11/1991 - 12/1996	A 135 APC	A 140 EHD		
113 E 113 E/360	01/1990 - 12/1996	A 135 APC	A 140 EHD		
113 E 113 E/380	01/1991 - 12/1996	A 135 APC	A 140 EHD		
113 H 113 H/310	01/1990 - 12/1991	A 135 APC	A 140 EHD		
113 H 113 H/310	05/1988 - 12/1989	A 135 APC	A 140 EHD		
113 H 113 H/320	01/1990 - 12/1996	A 135 APC	A 140 EHD		
113 H 113 H/320	05/1988 - 12/1989	A 135 APC	A 140 EHD		
113 H 113 H/360	01/1989 - 12/1989	A 135 APC	A 140 EHD		
113 H 113 H/360	01/1990 - 12/1996	A 135 APC	A 140 EHD		
113 H 113 H/360	05/1988 - 12/1989	A 135 APC	A 140 EHD		
113 H 113 H/380	01/1991 - 12/1996	A 135 APC	A 140 EHD		

MARCHIO E MODELLO - MAKE AND MODEL MARQUE ET MODÈLE - MARKE UND MODELL MARCA Y MODELO - МАРКА И МОДЕЛЬ	Periodo Period	powerCUBE		energyCUBE	
		APC	EHD	APC	RST
SCANIA					
<i>cont.</i>					
113 M 113 M/320	01/1990 - 12/1996	A 135 APC	A 140 EHD		
113 M 113 M/320	05/1988 - 12/1989	A 135 APC	A 140 EHD		
113 M 113 M/360	01/1990 - 12/1996	A 135 APC	A 140 EHD		
113 M 113 M/360	05/1988 - 12/1989	A 135 APC	A 140 EHD		
113 M 113 M/380	01/1991 - 12/1996	A 135 APC	A 140 EHD		
113 M 113 M/400	01/1992 - 12/1996	A 135 APC	A 140 EHD		
113 M 113 M/400	01/1993 - 12/1996	A 135 APC	A 140 EHD		
114 C 114 C/340	03/1998 -	B 180 APC	B 180 EHD / B 160 EHD	B 185 APC	
114 C 114 C/340	05/1996 -	B 180 APC	B 180 EHD / B 160 EHD	B 185 APC	
114 C 114 C/380	03/1998 -	B 180 APC	B 180 EHD / B 160 EHD	B 185 APC	
114 G 113 G/340	03/1998 -	B 180 APC	B 180 EHD / B 160 EHD	B 185 APC	
114 G 114 /G380	03/1998 -	B 180 APC	B 180 EHD / B 160 EHD	B 185 APC	
114 G 114 G/340	03/1998 -	B 180 APC	B 180 EHD / B 160 EHD	B 185 APC	
114 G 114 G/340	05/1996 -	B 180 APC	B 180 EHD / B 160 EHD	B 185 APC	
114 G 114 G/380	03/1998 -	B 180 APC	B 180 EHD / B 160 EHD	B 185 APC	
114 L 114 L/340	03/1998 -	B 180 APC	B 180 EHD / B 160 EHD	B 185 APC	
114 L 114 L/340	05/1996 -	B 180 APC	B 180 EHD / B 160 EHD	B 185 APC	
114 L 114 L/380	03/1998 -	B 180 APC	B 180 EHD / B 160 EHD	B 185 APC	
124 C 124 C/360	09/1996 -	CX 225 APC	CX 200 EHD	CX 220 APC	
124 C 124 C/400	09/1996 -	CX 225 APC	CX 200 EHD	CX 220 APC	
124 G 124 G/360	05/1996 -	CX 225 APC	CX 200 EHD	CX 220 APC	
124 G 124 G/400	05/1996 -	CX 225 APC	CX 200 EHD	CX 220 APC	
124 L 124 L/360	09/1996 -	CX 225 APC	CX 200 EHD	CX 220 APC	
124 L 124 L/400	09/1996 -	CX 225 APC	CX 200 EHD	CX 220 APC	
124 L 124 L/420	09/1997 -	CX 225 APC	CX 200 EHD	CX 220 APC	
124 L 124 L/440	01/2001 -	CX 225 APC	CX 200 EHD	CX 220 APC	
124 L 124 L/470	01/2001 -	CX 225 APC	CX 200 EHD	CX 220 APC	
143 E 143 E/420	01/1991 - 12/1996	B 180 APC	B 180 EHD / B 160 EHD	B 185 APC	
143 E 143 E/450	01/1990 - 12/1996	B 180 APC	B 180 EHD / B 160 EHD	B 185 APC	
143 E 143 E/500	01/1991 - 12/1996	B 180 APC	B 180 EHD / B 160 EHD	B 185 APC	
143 H 143 H/400	01/1990 - 12/1991	B 180 APC	B 180 EHD / B 160 EHD	B 185 APC	
143 H 143 H/400	05/1988 - 12/1989	B 180 APC	B 180 EHD / B 160 EHD	B 185 APC	
143 H 143 H/420	01/1991 - 12/1993	B 180 APC	B 180 EHD / B 160 EHD	B 185 APC	
143 H 143 H/420	01/1991 - 12/1996	B 180 APC	B 180 EHD / B 160 EHD	B 185 APC	
143 H 143 H/450	01/1990 - 12/1996	B 180 APC	B 180 EHD / B 160 EHD	B 185 APC	
143 H 143 H/450	05/1988 - 12/1989	B 180 APC	B 180 EHD / B 160 EHD	B 185 APC	
143 H 143 H/470	01/1990 - 05/1991	B 180 APC	B 180 EHD / B 160 EHD	B 185 APC	
143 H 143 H/470	03/1988 - 12/1989	B 180 APC	B 180 EHD / B 160 EHD	B 185 APC	
143 H 143 H/500	01/1991 - 12/1996	B 180 APC	B 180 EHD / B 160 EHD	B 185 APC	
143 M 143 M/420	01/1991 - 12/1996	B 180 APC	B 180 EHD / B 160 EHD	B 185 APC	
143 M 143 M/450	01/1990 - 12/1996	B 180 APC	B 180 EHD / B 160 EHD	B 185 APC	
143 M 143 M/450	05/1988 - 12/1989	B 180 APC	B 180 EHD / B 160 EHD	B 185 APC	
143 M 143 M/470	01/1990 - 05/1991	B 180 APC	B 180 EHD / B 160 EHD	B 185 APC	
143 M 143 M/470	03/1988 - 12/1989	B 180 APC	B 180 EHD / B 160 EHD	B 185 APC	
143 M 143 M/500	01/1991 - 12/1996	B 180 APC	B 180 EHD / B 160 EHD	B 185 APC	

MARCHIO E MODELLO - MAKE AND MODEL MARQUE ET MODÈLE - MARKE UND MODELL MARCA Y MODELO - МАРКА И МОДЕЛЬ	Periodo Period	powerCUBE		energyCUBE	
		APC	EHD	APC	RST
SCANIA					
<i>cont.</i>					
144 C 144 C/460	09/1996 -	CX 225 APC	CX 200 EHD	CX 220 APC	
144 C 144 C/530	09/1996 -	CX 225 APC	CX 200 EHD	CX 220 APC	
144 G 144 G/460	04/1996 -	CX 225 APC	CX 200 EHD	CX 220 APC	
144 G 144 G/530	04/1996 -	CX 225 APC	CX 200 EHD	CX 220 APC	
144 L 144 L/460	11/1995 -	CX 225 APC	CX 200 EHD	CX 220 APC	
144 L 144 L/530	11/1995 -	CX 225 APC	CX 200 EHD	CX 220 APC	
164 C 164 C/480	05/2000 -	CX 225 APC	CX 200 EHD	CX 220 APC	
164 C 164 C/580	05/2000 -	CX 225 APC	CX 200 EHD	CX 220 APC	
164 G 164 G/480	05/2000 -	CX 225 APC	CX 200 EHD	CX 220 APC	
164 G 164 G/580	05/2000 -	CX 225 APC	CX 200 EHD	CX 220 APC	
164 L 164 L/480	05/2000 -	CX 225 APC	CX 200 EHD	CX 220 APC	
164 L 164 L/580	05/2000 -	CX 225 APC	CX 200 EHD	CX 220 APC	
2 - series R 142 E	05/1980 - 03/1988	B 180 APC	B 180 EHD	B 185 APC	
2 - series R 142 H	05/1980 - 03/1988	B 180 APC	B 180 EHD	B 185 APC	
2 - series R 142 M	05/1980 - 03/1988	B 180 APC	B 180 EHD	B 185 APC	
2 - series T 142 E	05/1980 - 03/1988	B 180 APC	B 180 EHD	B 185 APC	
4 - series 114 C/330		B 180 APC	B 180 EHD	B 185 APC	
4 - series 114 C/340		B 180 APC	B 180 EHD	B 185 APC	
4 - series 114 C/380		B 180 APC	B 180 EHD	B 185 APC	
4 - series 114 G/340		B 180 APC	B 180 EHD	B 185 APC	
4 - series 114 G/340	03/1998 -	B 180 APC	B 180 EHD	B 185 APC	
4 - series 114 G/380		B 180 APC	B 180 EHD	B 185 APC	
4 - series 114 L/340		B 180 APC	B 180 EHD	B 185 APC	
4 - series 114 L/380		B 180 APC	B 180 EHD	B 185 APC	
4 - series 114 L/530		CX 225 APC	CX 200 EHD	CX 220 APC	
4 - series 124 /G420		B 180 APC	B 180 EHD	B 185 APC	
4 - series 124 C/360		B 180 APC	B 180 EHD	B 185 APC	
4 - series 124 C/420		B 180 APC	B 180 EHD	B 185 APC	
4 - series 124 C/470		B 180 APC	B 180 EHD	B 185 APC	
4 - series 124 G/ 420		B 180 APC	B 180 EHD	B 185 APC	
4 - series 124 G/420		B 180 APC	B 180 EHD	B 185 APC	
4 - series 124 G/470		B 180 APC	B 180 EHD	B 185 APC	
4 - series 124 L/420		B 180 APC	B 180 EHD	B 185 APC	
4 - series 124 L/470		B 180 APC	B 180 EHD	B 185 APC	
4 - series 144 L/460		B 180 APC	B 180 EHD	B 185 APC	
4 - series 164 G/480		B 180 APC	B 180 EHD	B 185 APC	
4 - series 164 G/580		B 180 APC	B 180 EHD	B 185 APC	
4 - series 164 L/480		B 180 APC	B 180 EHD	B 185 APC	
4 - series 164 L/580		B 180 APC	B 180 EHD	B 185 APC	
4 - series 94 /D260		B 180 APC	B 180 EHD	B 185 APC	
4 - series 94 /G260		B 180 APC	B 180 EHD	B 185 APC	
4 - series 94 C/300		B 180 APC	B 180 EHD	B 185 APC	
4 - series 94 D/220		B 180 APC	B 180 EHD	B 185 APC	
4 - series 94 D/230		B 180 APC	B 180 EHD	B 185 APC	
4 - series 94 D/260		B 180 APC	B 180 EHD	B 185 APC	

MARCHIO E MODELLO - MAKE AND MODEL MARQUE ET MODÈLE - MARKE UND MODELL MARCA Y MODELO - МАРКА И МОДЕЛЬ	Periodo Period	powerCUBE		energyCUBE	
		APC	EHD	APC	RST
SCANIA					
<small>cont.</small>					
4 - series 94 D/270		B 180 APC	B 180 EHD	B 185 APC	
4 - series 94 D/300		B 180 APC	B 180 EHD	B 185 APC	
4 - series 94 D/310		B 180 APC	B 180 EHD	B 185 APC	
4 - series 94 G/260		B 180 APC	B 180 EHD	B 185 APC	
4 - series 94 G/310		B 180 APC	B 180 EHD	B 185 APC	
4 - series 94 L/310		B 180 APC	B 180 EHD	B 185 APC	
4 - series T 114 C/340		B 180 APC	B 180 EHD	B 185 APC	
4 - series T 114 C/380		B 180 APC	B 180 EHD	B 185 APC	
4 - series T 114 G/340		B 180 APC	B 180 EHD	B 185 APC	
4 - series T 114 G/380		B 180 APC	B 180 EHD	B 185 APC	
4 - series T 114 L/340		B 180 APC	B 180 EHD	B 185 APC	
4 - series T 114 L/380		B 180 APC	B 180 EHD	B 185 APC	
4 - series T 124 C/420		CX 225 APC	CX 200 EHD	CX 220 APC	
4 - series T 124 G/420		CX 225 APC	CX 200 EHD	CX 220 APC	
4 - series T 124 L/420		CX 225 APC	CX 200 EHD	CX 220 APC	
4 - series T 124 L/470		CX 225 APC	CX 200 EHD	CX 220 APC	
4 - series T 144 L/460	03/1997 -	B 180 APC	B 180 EHD	B 185 APC	
4 - series T 144 L/530	03/1997 -	B 180 APC	B 180 EHD	B 185 APC	
82 H 82 H/210	01/1981 - 12/1986	A 135 APC	A 140 EHD		
82 M 82 M/190	10/1982 - 03/1988	A 135 APC	A 140 EHD		
82 M 82 M/210	01/1981 - 12/1986	A 135 APC	A 140 EHD		
92 H 92 H/245	01/1985 - 12/1986	A 135 APC	A 140 EHD		
92 H 92 H/245	01/1987 - 12/1988	A 135 APC	A 140 EHD		
92 H 92 H/275	01/1985 - 12/1986	A 135 APC	A 140 EHD		
92 H 92 H/275	01/1987 - 12/1988	A 135 APC	A 140 EHD		
92 M 92 M/245	01/1985 - 12/1986	A 135 APC	A 140 EHD		
92 M 92 M/245	01/1987 - 12/1988	A 135 APC	A 140 EHD		
92 M 92 M/275	01/1985 - 03/1988	A 135 APC	A 140 EHD		
92 M 92 M/275	01/1985 - 12/1986	A 135 APC	A 140 EHD		
92 M 92 M/275	01/1987 - 12/1988	A 135 APC	A 140 EHD		
93 H 93 H/220	12/1991 - 12/1996	A 135 APC	A 140 EHD		
93 H 93 H/250	01/1989 - 12/1989	A 135 APC	A 140 EHD		
93 H 93 H/250	01/1990 - 12/1996	A 135 APC	A 140 EHD		
93 H 93 H/250	03/1988 - 12/1989	A 135 APC	A 140 EHD		
93 H 93 H/280	12/1991 - 12/1996	A 135 APC	A 140 EHD		
93 M 93 M/210	03/1988 - 12/1991	A 135 APC	A 140 EHD		
93 M 93 M/220	12/1991 - 12/1996	A 135 APC	A 140 EHD		
93 M 93 M/230	01/1990 - 12/1991	A 135 APC	A 140 EHD		
93 M 93 M/230	03/1988 - 12/1989	A 135 APC	A 140 EHD		
93 M 93 M/250	01/1990 - 12/1996	A 135 APC	A 140 EHD		
93 M 93 M/250	03/1988 - 12/1989	A 135 APC	A 140 EHD		
93 M 93 M/250	10/1990 - 12/1996	A 135 APC	A 140 EHD		
93 M 93 M/280	01/1990 - 12/1996	A 135 APC	A 140 EHD		
93 M 93 M/280	03/1988 - 12/1989	A 135 APC	A 140 EHD		
94 C 94 C/260	12/1996 -	B 180 APC	B 180 EHD / B 160 EHD	B 185 APC	

MARCHIO E MODELLO - MAKE AND MODEL MARQUE ET MODÈLE - MARKE UND MODELL MARCA Y MODELO - МАРКА И МОДЕЛЬ	Periodo Period	powerCUBE		energyCUBE	
		APC	EHD	APC	RST
SCANIA					
<i>cont.</i>					
94 C 94 C/310	08/1996 -	B 180 APC	B 180 EHD	B 185 APC	
94 D 94 D/220	08/1996 -	B 180 APC	B 180 EHD	B 185 APC	
94 D 94 D/230	08/1999 -	B 180 APC	B 180 EHD	B 185 APC	
94 D 94 D/260	08/1996 -	B 180 APC	B 180 EHD	B 185 APC	
94 D 94 D/310	01/1998 -	B 180 APC	B 180 EHD	B 185 APC	
94 D 94 D/310	12/1996 -	B 180 APC	B 180 EHD	B 185 APC	
94 G 94 G/220	01/1998 -	B 180 APC	B 180 EHD	B 185 APC	
94 G 94 G/220	08/1996 -	B 180 APC	B 180 EHD	B 185 APC	
94 G 94 G/260	01/1998 -	B 180 APC	B 180 EHD	B 185 APC	
94 G 94 G/260	08/1996 -	B 180 APC	B 180 EHD	B 185 APC	
94 G 94 G/310	08/1996 -	B 180 APC	B 180 EHD	B 185 APC	
94 L 94 L/310	08/1996 -	B 180 APC	B 180 EHD	B 185 APC	
IRIZAR PB 12.35		CX 225 APC		CX 220 APC	
IRIZAR PB 12.37		CX 225 APC		CX 220 APC	
IRIZAR PB 12.92, 13.87, 15.37		CX 225 APC		CX 220 APC	
K - series K 270 Ethanol	01/2006 -	CX 225 APC		CX 220 APC	
K - series K 310 IB, K 310 UB	09/2003 -	CX 225 APC		CX 220 APC	
K - series K 400 IB	01/2006 -	CX 225 APC		CX 220 APC	
K - series K 440 IB	01/2006 -	CX 225 APC		CX 220 APC	
K 113 K 113	11/1990 -	CX 225 APC		CX 220 APC	
K 113 K 113 CLB	01/1991 - 12/1997	CX 225 APC		CX 220 APC	
K 113 K 113 CLB	07/1990 - 12/1996	CX 225 APC		CX 220 APC	
K 93 K 93 CL	01/1991 - 12/1996	A 135 APC	A 140 EHD		
L 113 L 113 CLB	01/1990 - 12/1996	CX 225 APC		CX 220 APC	
L 113 L 113 CLB	11/1993 - 12/1996	CX 225 APC		CX 220 APC	
P (vuoto)	09/2004 -	B 180 APC	B 180 EHD	B 185 APC	
P,R,T - series G 230		B 180 APC	B 180 EHD	B 185 APC	
P,R,T - series G 230, P 230	09/2007 -	B 180 APC	B 180 EHD	B 185 APC	
P,R,T - series G 270 P 270		B 180 APC	B 180 EHD	B 185 APC	
P,R,T - series G 310 P 310		B 180 APC	B 180 EHD	B 185 APC	
P,R,T - series G 340 P 340		B 180 APC	B 180 EHD	B 185 APC	
P,R,T - series G 340 P 340	08/2004 -	B 180 APC	B 180 EHD	B 185 APC	
P,R,T - series G 340 P 340 R 340		B 180 APC	B 180 EHD	B 185 APC	
P,R,T - series G 360, P 360	04/2010 -	B 180 APC	B 180 EHD	B 185 APC	
P,R,T - series G 380 P 380		B 180 APC	B 180 EHD	B 185 APC	
P,R,T - series G 380 P 380	08/2004 -	B 180 APC	B 180 EHD	B 185 APC	
P,R,T - series G 380 P 380 R 380		B 180 APC	B 180 EHD	B 185 APC	
P,R,T - series G 380 P 380 R 380	03/2008 -	B 180 APC	B 180 EHD	B 185 APC	
P,R,T - series G 400, R 400	03/2009 -	B 180 APC	B 180 EHD	B 185 APC	
P,R,T - series G 410, P 410, R 410	09/2013 -	B 180 APC	B 180 EHD	B 185 APC	
P,R,T - series G 410, P 410, R410	09/2013 -	B 180 APC	B 180 EHD	B 185 APC	
P,R,T - series G 410, R 410	09/2013 -	B 180 APC	B 180 EHD	B 185 APC	
P,R,T - series G 420		B 180 APC	B 180 EHD	B 185 APC	
P,R,T - series G 420 R 420	01/2008 -	B 180 APC	B 180 EHD	B 185 APC	
P,R,T - series G 420, R 420	01/2008 -	B 180 APC	B 180 EHD	B 185 APC	

MARCHIO E MODELLO - MAKE AND MODEL MARQUE ET MODÈLE - MARKE UND MODELL MARCA Y MODELO - МАРКА И МОДЕЛЬ	Periodo Period	powerCUBE		energyCUBE	
		APC	EHD	APC	RST
SCANIA					
<small>cont.</small>					
P,R,T - series G 440	04/2010 -	B 180 APC	B 180 EHD	B 185 APC	
P,R,T - series G 450, P 450, R 450	09/2013 -	B 180 APC	B 180 EHD	B 185 APC	
P,R,T - series G 450, R 450	09/2013 -	B 180 APC	B 180 EHD	B 185 APC	
P,R,T - series G 480 R 480		B 180 APC	B 180 EHD	B 185 APC	
P,R,T - series G 480 R 480	01/2008 -	B 180 APC	B 180 EHD	B 185 APC	
P,R,T - series G 480 R 480	03/2008 -	B 180 APC	B 180 EHD	B 185 APC	
P,R,T - series G 490, R 490	09/2013 -	B 180 APC	B 180 EHD	B 185 APC	
P,R,T - series P 230		B 180 APC	B 180 EHD	B 185 APC	
P,R,T - series P 230	01/2008 -	B 180 APC	B 180 EHD	B 185 APC	
P,R,T - series P 230	04/2006 -	B 180 APC	B 180 EHD	B 185 APC	
P,R,T - series P 230	07/2009 -	B 180 APC	B 180 EHD	B 185 APC	
P,R,T - series P 230	08/2006 -	B 180 APC	B 180 EHD	B 185 APC	
P,R,T - series P 230	08/2012 -	B 180 APC	B 180 EHD	B 185 APC	
P,R,T - series P 230	09/2004 -	B 180 APC	B 180 EHD	B 185 APC	
P,R,T - series P 230 R 230		B 180 APC	B 180 EHD	B 185 APC	
P,R,T - series P 250	08/2012 -	B 180 APC	B 180 EHD	B 185 APC	
P,R,T - series P 250	09/2013 -	B 180 APC	B 180 EHD	B 185 APC	
P,R,T - series P 260		B 180 APC	B 180 EHD	B 185 APC	
P,R,T - series P 270		B 180 APC	B 180 EHD	B 185 APC	
P,R,T - series P 270	01/2008 -	B 180 APC	B 180 EHD	B 185 APC	
P,R,T - series P 270	04/2006 -	B 180 APC	B 180 EHD	B 185 APC	
P,R,T - series P 270	08/2006 -	B 180 APC	B 180 EHD	B 185 APC	
P,R,T - series P 270 R 270		B 180 APC	B 180 EHD	B 185 APC	
P,R,T - series P 280		B 180 APC	B 180 EHD	B 185 APC	
P,R,T - series P 280	07/2009 -	B 180 APC	B 180 EHD	B 185 APC	
P,R,T - series P 280	08/2012 -	B 180 APC	B 180 EHD	B 185 APC	
P,R,T - series P 280	09/2013 -	B 180 APC	B 180 EHD	B 185 APC	
P,R,T - series P 300		B 180 APC	B 180 EHD	B 185 APC	
P,R,T - series P 310		B 180 APC	B 180 EHD	B 185 APC	
P,R,T - series P 310	01/2008 -	B 180 APC	B 180 EHD	B 185 APC	
P,R,T - series P 310	04/2006 -	B 180 APC	B 180 EHD	B 185 APC	
P,R,T - series P 310	08/2006 -	B 180 APC	B 180 EHD	B 185 APC	
P,R,T - series P 310	08/2012 -	B 180 APC	B 180 EHD	B 185 APC	
P,R,T - series P 310	09/2004 -	B 180 APC	B 180 EHD	B 185 APC	
P,R,T - series P 310 R 310		B 180 APC	B 180 EHD	B 185 APC	
P,R,T - series P 320	08/2012 -	B 180 APC	B 180 EHD	B 185 APC	
P,R,T - series P 320	09/2013 -	B 180 APC	B 180 EHD	B 185 APC	
P,R,T - series P 340		B 180 APC	B 180 EHD	B 185 APC	
P,R,T - series P 340	09/2004 -	B 180 APC	B 180 EHD	B 185 APC	
P,R,T - series P 340	10/2006 -	B 180 APC	B 180 EHD	B 185 APC	
P,R,T - series P 340 R 340		B 180 APC	B 180 EHD	B 185 APC	
P,R,T - series P 340 R 340	08/2006 -	B 180 APC	B 180 EHD	B 185 APC	
P,R,T - series P 340 R 340	09/2004 -	B 180 APC	B 180 EHD	B 185 APC	
P,R,T - series P 340, R 340	09/2005 -	B 180 APC	B 180 EHD	B 185 APC	
P,R,T - series P 340, R 340	10/2006 -	B 180 APC	B 180 EHD	B 185 APC	

MARCHIO E MODELLO - MAKE AND MODEL MARQUE ET MODÈLE - MARKE UND MODELL MARCA Y MODELO - МАРКА И МОДЕЛЬ	Periodo Period	powerCUBE		energyCUBE	
		APC	EHD	APC	RST
SCANIA					
<i>cont.</i>					
P,R,T - series P 360	04/2010 -	B 180 APC	B 180 EHD	B 185 APC	
P,R,T - series P 360	07/2009 -	B 180 APC	B 180 EHD	B 185 APC	
P,R,T - series P 360	09/2009 -	B 180 APC	B 180 EHD	B 185 APC	
P,R,T - series P 360	09/2013 -	B 180 APC	B 180 EHD	B 185 APC	
P,R,T - series P 360, R 360	04/2010 -	B 180 APC	B 180 EHD	B 185 APC	
P,R,T - series P 370	09/2013 -	B 180 APC	B 180 EHD	B 185 APC	
P,R,T - series P 380		B 180 APC	B 180 EHD	B 185 APC	
P,R,T - series P 380	09/2004 -	B 180 APC	B 180 EHD	B 185 APC	
P,R,T - series P 380	09/2005 -	B 180 APC	B 180 EHD	B 185 APC	
P,R,T - series P 380	10/2006 -	B 180 APC	B 180 EHD	B 185 APC	
P,R,T - series P 380 R 380		B 180 APC	B 180 EHD	B 185 APC	
P,R,T - series P 380 R 380	09/2004 -	B 180 APC	B 180 EHD	B 185 APC	
P,R,T - series P 380 R 380	10/2006 -	B 180 APC	B 180 EHD	B 185 APC	
P,R,T - series P 380, R 380	09/2005 -	B 180 APC	B 180 EHD	B 185 APC	
P,R,T - series P 380, R 380	10/2006 -	B 180 APC	B 180 EHD	B 185 APC	
P,R,T - series P 400	04/2010 -	B 180 APC	B 180 EHD	B 185 APC	
P,R,T - series P 400	07/2009 -	B 180 APC	B 180 EHD	B 185 APC	
P,R,T - series P 400, R 400	04/2010 -	B 180 APC	B 180 EHD	B 185 APC	
P,R,T - series P 410	09/2013 -	B 180 APC	B 180 EHD	B 185 APC	
P,R,T - series P 420		B 180 APC	B 180 EHD	B 185 APC	
P,R,T - series P 420	09/2004 -	B 180 APC	B 180 EHD	B 185 APC	
P,R,T - series P 420	09/2005 -	B 180 APC	B 180 EHD	B 185 APC	
P,R,T - series P 420 R 420		B 180 APC	B 180 EHD	B 185 APC	
P,R,T - series P 420, R 420	08/2006 -	B 180 APC	B 180 EHD	B 185 APC	
P,R,T - series P 420, R 420	09/2005 -	B 180 APC	B 180 EHD	B 185 APC	
P,R,T - series P 440, R 440	04/2010 -	B 180 APC	B 180 EHD	B 185 APC	
P,R,T - series P 450	09/2013 -	B 180 APC	B 180 EHD	B 185 APC	
P,R,T - series P 470, R 470	09/2005 -	B 180 APC	B 180 EHD	B 185 APC	
P,R,T - series P 480 R 480		B 180 APC	B 180 EHD	B 185 APC	
P,R,T - series P 480, R 480	04/2010 -	B 180 APC	B 180 EHD	B 185 APC	
P,R,T - series P 500 R 500		B 180 APC	B 180 EHD	B 185 APC	
P,R,T - series P 500, R 500	07/2009 -	B 180 APC	B 180 EHD	B 185 APC	
P,R,T - series R 340		B 180 APC	B 180 EHD	B 185 APC	
P,R,T - series R 340	08/2006 -	B 180 APC	B 180 EHD	B 185 APC	
P,R,T - series R 360	04/2010 -	B 180 APC	B 180 EHD	B 185 APC	
P,R,T - series R 380		B 180 APC	B 180 EHD	B 185 APC	
P,R,T - series R 380	04/2010 -	B 180 APC	B 180 EHD	B 185 APC	
P,R,T - series R 380	09/2004 -	B 180 APC	B 180 EHD	B 185 APC	
P,R,T - series R 400	03/2008 -	B 180 APC	B 180 EHD	B 185 APC	
P,R,T - series R 400	04/2010 -	B 180 APC	B 180 EHD	B 185 APC	
P,R,T - series R 420		B 180 APC	B 180 EHD	B 185 APC	
P,R,T - series R 420	04/2004 -	B 180 APC	B 180 EHD	B 185 APC	
P,R,T - series R 420	11/2004 -	B 180 APC	B 180 EHD	B 185 APC	
P,R,T - series R 440	03/2008 -	B 180 APC	B 180 EHD	B 185 APC	
P,R,T - series R 440	04/2010 -	B 180 APC	B 180 EHD	B 185 APC	

MARCHIO E MODELLO - MAKE AND MODEL MARQUE ET MODÈLE - MARKE UND MODELL MARCA Y MODELO - МАРКА И МОДЕЛЬ	Periodo Period	powerCUBE		energyCUBE	
		APC	EHD	APC	RST
SCANIA cont.					
P,R,T - series R 470		B 180 APC	B 180 EHD	B 185 APC	
P,R,T - series R 470	04/2004 -	B 180 APC	B 180 EHD	B 185 APC	
P,R,T - series R 480		B 180 APC	B 180 EHD	B 185 APC	
P,R,T - series R 480	04/2004 -	B 180 APC	B 180 EHD	B 185 APC	
P,R,T - series R 480	04/2010 -	B 180 APC	B 180 EHD	B 185 APC	
P,R,T - series R 480	07/2004 -	B 180 APC	B 180 EHD	B 185 APC	
P,R,T - series R 480	08/2006 -	B 180 APC	B 180 EHD	B 185 APC	
P,R,T - series R 480	10/2010 -	B 180 APC	B 180 EHD	B 185 APC	
P,R,T - series R 480 G 480	03/2008 -	B 180 APC	B 180 EHD	B 185 APC	
P,R,T - series R 500		B 180 APC	B 180 EHD	B 185 APC	
P,R,T - series R 500	01/2004 -	B 180 APC	B 180 EHD	B 185 APC	
P,R,T - series R 500	04/2004 -	B 180 APC	B 180 EHD	B 185 APC	
P,R,T - series R 560		B 180 APC	B 180 EHD	B 185 APC	
P,R,T - series R 560	03/2008 -	B 180 APC	B 180 EHD	B 185 APC	
P,R,T - series R 560	04/2004 -	B 180 APC	B 180 EHD	B 185 APC	
P,R,T - series R 560	09/2006 -	B 180 APC	B 180 EHD	B 185 APC	
P,R,T - series R 560	11/2006 -	B 180 APC	B 180 EHD	B 185 APC	
P,R,T - series R 560, P 560	07/2009 -	B 180 APC	B 180 EHD	B 185 APC	
P,R,T - series R 580		B 180 APC	B 180 EHD	B 185 APC	
P,R,T - series R 580	04/2004 -	B 180 APC	B 180 EHD	B 185 APC	
P,R,T - series R 580, P 580	07/2009 -	B 180 APC	B 180 EHD	B 185 APC	
P,R,T - series R 620		B 180 APC	B 180 EHD	B 185 APC	
P,R,T - series R 620	03/2008 -	B 180 APC	B 180 EHD	B 185 APC	
P,R,T - series R 620	08/2006 -	B 180 APC	B 180 EHD	B 185 APC	
P,R,T - series R 620	09/2005 -	B 180 APC	B 180 EHD	B 185 APC	
P,R,T - series R 620	10/2004 -	B 180 APC	B 180 EHD	B 185 APC	
P,R,T - series R 620	11/2006 -	B 180 APC	B 180 EHD	B 185 APC	
P,R,T - series R 730	04/2010 -	B 180 APC	B 180 EHD	B 185 APC	
P,R,T - series R 730	10/2010 -	B 180 APC	B 180 EHD	B 185 APC	
P,R,T - series T 470	09/2004 - 10/2005	B 180 APC	B 180 EHD	B 185 APC	
R 340	03/2004 -	B 180 APC	B 180 EHD	B 185 APC	
R 380	03/2004 -	B 180 APC	B 180 EHD	B 185 APC	
R 420	03/2004 -	B 180 APC	B 180 EHD	B 185 APC	
R 470	03/2004 -	B 180 APC	B 180 EHD	B 185 APC	
R 500	03/2004 -	B 180 APC	B 180 EHD	B 185 APC	
R 580	03/2004 -	B 180 APC	B 180 EHD	B 185 APC	
T 113 E T 113 E/320	01/1990 - 12/1996	B 180 APC	B 180 EHD	B 185 APC	
T 113 E T 113 E/360	01/1990 - 12/1996	B 180 APC	B 180 EHD	B 185 APC	
T 113 H T 113 H/320	01/1990 - 12/1996	B 180 APC	B 180 EHD	B 185 APC	
T 113 H T 113 H/360	01/1990 - 12/1996	B 180 APC	B 180 EHD	B 185 APC	
T 114 C T 114 C/340	03/1998 -	B 180 APC	B 180 EHD	B 185 APC	
T 114 C T 114 C/380	03/1998 -	B 180 APC	B 180 EHD	B 185 APC	
T 114 G T 114 G/340	03/1998 -	B 180 APC	B 180 EHD	B 185 APC	
T 114 G T 114 G/340	05/1996 -	B 180 APC	B 180 EHD	B 185 APC	
T 114 G T 114 G/380	03/1998 -	B 180 APC	B 180 EHD	B 185 APC	

MARCHIO E MODELLO - MAKE AND MODEL MARQUE ET MODÈLE - MARKE UND MODELL MARCA Y MODELO - МАРКА И МОДЕЛЬ	Periodo Period	powerCUBE		energyCUBE	
		APC	EHD	APC	RST
SCANIA					
<i>cont.</i>					
T 114 LT 114 L/340	03/1998 -	B 180 APC	B 180 EHD	B 185 APC	
T 114 LT 114 L/340	05/1996 -	B 180 APC	B 180 EHD	B 185 APC	
T 114 LT 114 L/380	03/1998 -	B 180 APC	B 180 EHD	B 185 APC	
T 124 C T 124 /C420	05/1996 -	CX 225 APC	CX 200 EHD	CX 220 APC	
T 124 C T 124 C/360	09/1995 -	CX 225 APC	CX 200 EHD	CX 220 APC	
T 124 C T 124 C/400	05/1996 -	CX 225 APC	CX 200 EHD	CX 220 APC	
T 124 C T 124 C/420	05/1996 -	CX 225 APC	CX 200 EHD	CX 220 APC	
T 124 C T 124 C/420	09/1997 -	CX 225 APC	CX 200 EHD	CX 220 APC	
T 124 G T 124 G/360	03/1997 -	CX 225 APC	CX 200 EHD	CX 220 APC	
T 124 G T 124 G/400	03/1997 -	CX 225 APC	CX 200 EHD	CX 220 APC	
T 124 G T 124 G/420	05/1996 -	CX 225 APC	CX 200 EHD	CX 220 APC	
T 124 G T 124 G/420	09/1997 -	CX 225 APC	CX 200 EHD	CX 220 APC	
T 124 LT 124 L/360	02/1997 -	CX 225 APC	CX 200 EHD	CX 220 APC	
T 124 LT 124 L/360	05/1995 -	CX 225 APC	CX 200 EHD	CX 220 APC	
T 124 LT 124 L/360	09/1995 -	CX 225 APC	CX 200 EHD	CX 220 APC	
T 124 LT 124 L/400	02/1997 -	CX 225 APC	CX 200 EHD	CX 220 APC	
T 124 LT 124 L/400	05/1996 -	CX 225 APC	CX 200 EHD	CX 220 APC	
T 124 LT 124 L/420	05/1996 -	CX 225 APC	CX 200 EHD	CX 220 APC	
T 124 LT 124 L/420	09/1997 -	CX 225 APC	CX 200 EHD	CX 220 APC	
T 124 LT 124 L/470	01/2001 -	CX 225 APC	CX 200 EHD	CX 220 APC	
T 143 E T 143 E/420	01/1991 - 12/1996	CX 225 APC	CX 200 EHD	CX 220 APC	
T 143 E T 143 E/450	01/1990 - 12/1996	CX 225 APC	CX 200 EHD	CX 220 APC	
T 143 E T 143 E/500	01/1991 - 12/1996	CX 225 APC	CX 200 EHD	CX 220 APC	
T 143 H T 143 H/420	01/1991 - 12/1996	CX 225 APC	CX 200 EHD	CX 220 APC	
T 143 H T 143 H/450	01/1990 - 12/1996	CX 225 APC	CX 200 EHD	CX 220 APC	
T 143 H T 143 H/500	01/1991 - 12/1996	CX 225 APC	CX 200 EHD	CX 220 APC	
T 144 C T 144 C/460	09/1995 -	CX 225 APC	CX 200 EHD	CX 220 APC	
T 144 C T 144 C/530	09/1995 -	CX 225 APC	CX 200 EHD	CX 220 APC	
T 144 G T 144 G/460	03/1997 -	CX 225 APC	CX 200 EHD	CX 220 APC	
T 144 G T 144 G/530	03/1997 -	CX 225 APC	CX 200 EHD	CX 220 APC	
T 144 LT 144 L/460	03/1997 -	CX 225 APC	CX 200 EHD	CX 220 APC	
T 144 LT 144 L/460	09/1995 -	CX 225 APC	CX 200 EHD	CX 220 APC	
T 144 LT 144 L/530	03/1997 -	CX 225 APC	CX 200 EHD	CX 220 APC	
T 144 LT 144 L/530	09/1995 -	CX 225 APC	CX 200 EHD	CX 220 APC	
T 93 H T 93 H/250	01/1990 - 12/1996	A 135 APC	A 140 EHD		
T 93 H T 93 H/280	12/1991 - 12/1996	A 135 APC	A 140 EHD		
T 94 C T 94 C/260	12/1996 -	B 180 APC	B 180 EHD / B 160 EHD	B 185 APC	
T 94 C T 94 C/310	09/1996 -	B 180 APC	B 180 EHD / B 160 EHD	B 185 APC	
T 94 G T 94 G/220	08/1996 -	B 180 APC	B 180 EHD / B 160 EHD	B 185 APC	
T 94 G T 94 G/230	04/1999 -	B 180 APC	B 180 EHD / B 160 EHD	B 185 APC	
T 94 G T 94 G/260	12/1996 -	B 180 APC	B 180 EHD / B 160 EHD	B 185 APC	
T 94 G T 94 G/310	09/1996 -	B 180 APC	B 180 EHD / B 160 EHD	B 185 APC	
T 94 G T 94 G/310	12/1996 -	B 180 APC	B 180 EHD / B 160 EHD	B 185 APC	
T 94 L T 94 L/310	09/1996 -	B 180 APC	B 180 EHD / B 160 EHD	B 185 APC	

MARCHIO E MODELLO - MAKE AND MODEL MARQUE ET MODÈLE - MARKE UND MODELL MARCA Y MODELO - МАРКА И МОДЕЛЬ	Periodo Period	powerCUBE		energyCUBE	
		APC	EHD	APC	RST
VAN HOOL					
A-Serie A 308		CX 225 APC		CX 220 APC	
A-Serie A 330		CX 225 APC		CX 220 APC	
A-Serie AG 300		CX 225 APC		CX 220 APC	
T-Serie T 911	10/2005 -	CX 225 APC		CX 220 APC	
T-Serie T 911	10/2006 -	CX 225 APC		CX 220 APC	
T-Serie T 915, T 916		CX 225 APC		CX 220 APC	
T-Serie T 915, T 916	10/2005 -	CX 225 APC		CX 220 APC	
T-Serie T 916, T 917, T 918, T 919		CX 225 APC		CX 220 APC	
T-Serie T 917		CX 225 APC		CX 220 APC	
T-Serie TD 925, TD 927		CX 225 APC		CX 220 APC	
VOLVO					
7700 7700	06/2006 -	CX 225 APC	CX 200 EHD	CX 220 APC	
8500 8500	01/1999 -	CX 225 APC		CX 220 APC	
8700 8700	01/1999 -	B 180 APC	B 180 EHD	B 185 APC	
9700 9700	01/2009 -	CX 225 APC	CX 200 EHD	CX 220 APC	
9700 9700	04/2001 -	CX 225 APC	CX 200 EHD	CX 220 APC	
9700 9700	10/2001 -	CX 225 APC	CX 200 EHD	CX 220 APC	
9700 9700	10/2007 -	CX 225 APC	CX 200 EHD	CX 220 APC	
9700 9900	04/2001 -	CX 225 APC	CX 200 EHD	CX 220 APC	
9900 9900	01/2009 -	CX 225 APC	CX 200 EHD	CX 220 APC	
9900 9900	10/2001 -	CX 225 APC	CX 200 EHD	CX 220 APC	
9900 9900	10/2007 -	CX 225 APC	CX 200 EHD	CX 220 APC	
A-Series A25C	01/1999 -	CX 225 APC		CX 220 APC	
A-Series A25D	01/2005 -	CX 225 APC		CX 220 APC	
A-Series A30D	01/2005 -	CX 225 APC		CX 220 APC	
A-Series A35D	01/2003 -	CX 225 APC		CX 220 APC	
A-Series A40D	01/2003 -	CX 225 APC		CX 220 APC	
B 10 B10M		CX 225 APC		CX 220 APC	
B 12 B 12	01/1992 -	B 180 APC	B 180 EHD / B 160 EHD	B 185 APC	
B 12 B 12	02/2006 -	B 180 APC	B 180 EHD / B 160 EHD	B 185 APC	
B 6 B6R, B6LE	11/1991 -				CB 110 RST (B01)
B 7 B 7		B 180 APC	B 180 EHD	B 185 APC	
B 9 B 9	09/2005 -	CX 225 APC		CX 220 APC	
F 10 F 10/260	01/1983 - 06/1985	A 135 APC	A 140 EHD / A 120 EHD		
F 10 F 10/260	02/1982 - 06/1985	A 135 APC	A 140 EHD / A 120 EHD		
F 10 F 10/280	08/1977 - 02/1982	A 135 APC	A 140 EHD / A 120 EHD		
F 10 F 10/300	01/1984 - 12/1986	A 135 APC	A 140 EHD / A 120 EHD		
F 10 F 10/300	01/1987 - 12/1987	A 135 APC	A 140 EHD / A 120 EHD		
F 10 F 10/300	10/1983 - 12/1986	A 135 APC	A 140 EHD / A 120 EHD		
F 10 F 10/320	10/1987 - 12/1990	A 135 APC	A 140 EHD / A 120 EHD		
F 10 F 10/320	12/1990 - 12/1994	A 135 APC	A 140 EHD / A 120 EHD		

MARCHIO E MODELLO - MAKE AND MODEL MARQUE ET MODÈLE - MARKE UND MODELL MARCA Y MODELO - МАРКА И МОДЕЛЬ	Periodo Period	powerCUBE		energyCUBE	
		APC	EHD	APC	RST
VOLVO					
cont.					
F 12 F 12/320	01/1987 - 12/1987	A 135 APC	A 140 EHD / A 120 EHD		
F 12 F 12/320,F 12/330	08/1977 - 12/1986	A 135 APC	A 140 EHD / A 120 EHD		
F 12 F 12/360	01/1988 - 12/1990	A 135 APC	A 140 EHD / A 120 EHD		
F 12 F 12/360	01/1991 - 12/1994	A 135 APC	A 140 EHD / A 120 EHD		
F 12 F 12/360	10/1990 - 12/1994	A 135 APC	A 140 EHD / A 120 EHD		
F 12 F 12/360	12/1990 - 12/1994	A 135 APC	A 140 EHD / A 120 EHD		
F 12 F 12/370	01/1987 - 12/1987	A 135 APC	A 140 EHD / A 120 EHD		
F 12 F 12/370	08/1977 - 12/1986	A 135 APC	A 140 EHD / A 120 EHD		
F 12 F 12/400	01/1988 - 12/1990	A 135 APC	A 140 EHD / A 120 EHD		
F 12 F 12/400	12/1990 - 12/1994	A 135 APC	A 140 EHD / A 120 EHD		
F 12 F 12/400,F 12/410	01/1988 - 12/1994	A 135 APC	A 140 EHD / A 120 EHD		
F 12 F 12/400,F 12/410	12/1990 - 12/1994	A 135 APC	A 140 EHD / A 120 EHD		
F 16 F 16/470	01/1988 - 12/1989	B 180 APC	B 180 EHD / B 160 EHD	B 185 APC	
F 16 F 16/485	01/1990 - 12/1992	B 180 APC	B 180 EHD / B 160 EHD	B 185 APC	
F 16 F 16/500	01/1992 - 12/1994	B 180 APC	B 180 EHD / B 160 EHD	B 185 APC	
F 4 F 406	09/1975 - 02/1986				CB 110 RST
F 4 F 408	04/1978 - 02/1986				CB 110 RST
F 6 F 609	03/1975 - 02/1980				CB 110 RST
F 6 F 610	02/1980 - 10/1986				CB 110 RST
F 6 F 611	02/1980 - 02/1986				CB 110 RST
F 6 F 611	09/1975 - 01/1980				CB 110 RST
F 6 F 612	04/1983 - 02/1986				CB 110 RST
F 6 F 613,F 614	09/1975 - 02/1986				CB 110 RST
F 6 F 615 S	12/1978 - 10/1981				CB 110 RST
F 6 F 616	02/1981 - 02/1986				CB 110 RST
F 6 F 617 S	12/1978 - 02/1986				CB 110 RST
F 7 F 7	08/1978 - 12/1985	A 135 APC	A 140 EHD / A 120 EHD		
F 80 F 86/207	08/1965 - 12/1974				CB 110 RST
F 80 F 88/260	08/1965 - 06/1977				CB 110 RST
F 80 F 89	10/1970 - 06/1977				CB 110 RST
F 80 F 89/330	10/1970 - 06/1977				CB 110 RST
FE FE 240-18	05/2006 -	B 180 APC	B 180 EHD	B 185 APC	
FE FE 240-22	05/2006 -	B 180 APC	B 180 EHD	B 185 APC	
FE FE 240-26		B 180 APC	B 180 EHD	B 185 APC	
FE FE 240-26	05/2006 -	B 180 APC	B 180 EHD	B 185 APC	
FE FE 260-18	05/2006 -	B 180 APC	B 180 EHD	B 185 APC	
FE FE 260-26		B 180 APC	B 180 EHD	B 185 APC	
FE FE 260-26	05/2006 -	B 180 APC	B 180 EHD	B 185 APC	
FE FE 280-18	05/2006 -	B 180 APC	B 180 EHD	B 185 APC	
FE FE 280-22	05/2006 -	B 180 APC	B 180 EHD	B 185 APC	
FE FE 280-26		B 180 APC	B 180 EHD	B 185 APC	
FE FE 280-26	05/2006 -	B 180 APC	B 180 EHD	B 185 APC	
FE FE 300-18	05/2006 -	B 180 APC	B 180 EHD	B 185 APC	
FE FE 300-26		B 180 APC	B 180 EHD	B 185 APC	
FE FE 300-26	05/2006 -	B 180 APC	B 180 EHD	B 185 APC	

MARCHIO E MODELLO - MAKE AND MODEL MARQUE ET MODÈLE - MARKE UND MODELL MARCA Y MODELO - МАРКА И МОДЕЛЬ	Periodo Period	powerCUBE		energyCUBE	
		APC	EHD	APC	RST
VOLVO cont.					
FE FE 320-18	05/2006 -	B 180 APC	B 180 EHD	B 185 APC	
FE FE 320-22	05/2006 -	B 180 APC	B 180 EHD	B 185 APC	
FE FE 320-26		B 180 APC	B 180 EHD	B 185 APC	
FE FE 320-26	05/2006 -	B 180 APC	B 180 EHD	B 185 APC	
FE FE 340-18	05/2006 -	B 180 APC	B 180 EHD	B 185 APC	
FE FE 340-26		B 180 APC	B 180 EHD	B 185 APC	
FE FE 340-26	05/2006 -	B 180 APC	B 180 EHD	B 185 APC	
FE II FE 240-18	05/2012 -	B 180 APC	B 180 EHD	B 185 APC	
FE II FE 240-26	05/2012 -	B 180 APC	B 180 EHD	B 185 APC	
FE II FE 250-18	05/2012 -	B 180 APC	B 180 EHD	B 185 APC	
FE II FE 250-26	05/2012 -	B 180 APC	B 180 EHD	B 185 APC	
FE II FE 260-18	05/2012 -	B 180 APC	B 180 EHD	B 185 APC	
FE II FE 260-26	05/2012 -	B 180 APC	B 180 EHD	B 185 APC	
FE II FE 280-18	05/2012 -	B 180 APC	B 180 EHD	B 185 APC	
FE II FE 280-26	05/2012 -	B 180 APC	B 180 EHD	B 185 APC	
FE II FE 300-18	05/2012 -	B 180 APC	B 180 EHD	B 185 APC	
FE II FE 300-26	05/2012 -	B 180 APC	B 180 EHD	B 185 APC	
FE II FE 320-18	05/2012 -	B 180 APC	B 180 EHD	B 185 APC	
FE II FE 320-26	05/2012 -	B 180 APC	B 180 EHD	B 185 APC	
FE II FE 340-18	05/2012 -	B 180 APC	B 180 EHD	B 185 APC	
FE II FE 340-26	05/2012 -	B 180 APC	B 180 EHD	B 185 APC	
FH 400	09/2005 -	CX 225 APC		CX 220 APC	
FH 420	01/2009 -	CX 225 APC		CX 220 APC	
FH 440	09/2005 -	CX 225 APC		CX 220 APC	
FH 460	01/2009 -	CX 225 APC		CX 220 APC	
FH 480	09/2005 -	CX 225 APC		CX 220 APC	
FH 500	01/2009 -	CX 225 APC		CX 220 APC	
FH 500	09/2007 -	CX 225 APC		CX 220 APC	
FH 520	09/2005 -	CX 225 APC		CX 220 APC	
FH 540	01/2009 -	CX 225 APC		CX 220 APC	
FH 550	09/2005 -	CX 225 APC		CX 220 APC	
FH 610	09/2005 -	CX 225 APC		CX 220 APC	
FH 12 FH 12/340	01/1995 -	B 180 APC	B 180 EHD / B 160 EHD	B 185 APC	
FH 12 FH 12/340	08/1993 -	B 180 APC	B 180 EHD / B 160 EHD	B 185 APC	
FH 12 FH 12/380	01/1995 -	B 180 APC	B 180 EHD / B 160 EHD	B 185 APC	
FH 12 FH 12/380	08/1993 -	B 180 APC	B 180 EHD / B 160 EHD	B 185 APC	
FH 12 FH 12/420	01/1995 -	B 180 APC	B 180 EHD / B 160 EHD	B 185 APC	
FH 12 FH 12/420	08/1993 -	B 180 APC	B 180 EHD / B 160 EHD	B 185 APC	
FH 12 FH 12/460	08/1998 -	B 180 APC	B 180 EHD / B 160 EHD	B 185 APC	
FH 12 FH 12-500	09/2001 -	B 180 APC	B 180 EHD / B 160 EHD	B 185 APC	
FH 16 FH 16	08/1993 - 12/1999	B 180 APC	B 180 EHD / B 160 EHD	B 185 APC	
FH 16 FH 16/470	08/1993 - 12/1999	B 180 APC	B 180 EHD / B 160 EHD	B 185 APC	
FH 16 FH 16/520	01/1995 -	B 180 APC	B 180 EHD / B 160 EHD	B 185 APC	
FH 16 FH 16/520	01/2003 -	B 180 APC	B 180 EHD / B 160 EHD	B 185 APC	
FH 16 FH 16/520	08/1993 - 12/2002	B 180 APC	B 180 EHD / B 160 EHD	B 185 APC	

MARCHIO E MODELLO - MAKE AND MODEL MARQUE ET MODÈLE - MARKE UND MODELL MARCA Y MODELO - МАРКА И МОДЕЛЬ	Periodo Period	powerCUBE		energyCUBE	
		APC	EHD	APC	RST
VOLVO <i>cont.</i>					
FH 16 FH 16/540	01/2009 -	B 180 APC	B 180 EHD / B 160 EHD	B 185 APC	
FH 16 FH 16/540, FH 16/550	08/2007 -	B 180 APC	B 180 EHD / B 160 EHD	B 185 APC	
FH 16 FH 16/550	01/2003 -	B 180 APC	B 180 EHD / B 160 EHD	B 185 APC	
FH 16 FH 16/580	01/2009 -	B 180 APC	B 180 EHD	B 185 APC	
FH 16 FH 16/580	09/2006 -	B 180 APC	B 180 EHD / B 160 EHD	B 185 APC	
FH 16 FH 16/600	01/2009 -	B 180 APC	B 180 EHD / B 160 EHD	B 185 APC	
FH 16 FH 16/600	09/2006 -	B 180 APC	B 180 EHD / B 160 EHD	B 185 APC	
FH 16 FH 16/610	01/2003 -	B 180 APC	B 180 EHD / B 160 EHD	B 185 APC	
FH 16 FH 16/610	08/2007 -	B 180 APC	B 180 EHD / B 160 EHD	B 185 APC	
FH 16 FH 16/660	01/2007 -	B 180 APC	B 180 EHD / B 160 EHD	B 185 APC	
FH 16 FH 16/660	01/2009 -	B 180 APC	B 180 EHD / B 160 EHD	B 185 APC	
FH 16 FH 16/660	09/2006 -	B 180 APC	B 180 EHD / B 160 EHD	B 185 APC	
FH 16 FH 16/700	01/2009 -	B 180 APC	B 180 EHD	B 185 APC	
FH 16 FH 16/700	09/2006 -	B 180 APC	B 180 EHD / B 160 EHD	B 185 APC	
FH 16 FH16	01/2003 -	B 180 APC	B 180 EHD / B 160 EHD	B 185 APC	
FH 16 II FH 16/540	05/2012 -	B 180 APC	B 180 EHD	B 185 APC	
FH 16 II FH 16/600	05/2012 -	B 180 APC	B 180 EHD	B 185 APC	
FH 16 II FH 16/700	05/2012 -	B 180 APC	B 180 EHD	B 185 APC	
FH 16 II FH 16/750	05/2012 -	B 180 APC	B 180 EHD	B 185 APC	
FH II 420	05/2012 -	B 180 APC	B 180 EHD	B 185 APC	
FH II 460	05/2012 -	B 180 APC	B 180 EHD	B 185 APC	
FH II 500	05/2012 -	B 180 APC	B 180 EHD	B 185 APC	
FH II 540	05/2012 -	B 180 APC	B 180 EHD	B 185 APC	
FL FL 180-10	03/2000 -	A 135 APC	A 140 EHD / A 120 EHD		
FL FL 180-11	03/2000 -	A 135 APC	A 140 EHD / A 120 EHD		
FL FL 180-12	03/2000 -	A 135 APC	A 140 EHD / A 120 EHD		
FL FL 180-13	03/2000 -	A 135 APC	A 140 EHD / A 120 EHD		
FL FL 180-14	03/2000 -	A 135 APC	A 140 EHD / A 120 EHD		
FL FL 180-15	03/2000 -	A 135 APC	A 140 EHD / A 120 EHD		
FL FL 180-16	03/2000 -	A 135 APC	A 140 EHD / A 120 EHD		
FL FL 180-17	03/2000 -	A 135 APC	A 140 EHD / A 120 EHD		
FL FL 180-18	03/2000 -	A 135 APC	A 140 EHD / A 120 EHD		
FL FL 180-7,5	03/2000 -	A 135 APC	A 140 EHD / A 120 EHD		
FL FL 180-8	03/2000 -	A 135 APC	A 140 EHD / A 120 EHD		
FL FL 180-9	03/2000 -	A 135 APC	A 140 EHD / A 120 EHD		
FL FL 220-10	03/2000 -	A 135 APC	A 140 EHD / A 120 EHD		
FL FL 220-11	03/2000 -	A 135 APC	A 140 EHD / A 120 EHD		
FL FL 220-12	03/2000 -	A 135 APC	A 140 EHD / A 120 EHD		
FL FL 220-13	03/2000 -	A 135 APC	A 140 EHD / A 120 EHD		
FL FL 220-14	03/2000 -	A 135 APC	A 140 EHD / A 120 EHD		
FL FL 220-15	03/2000 -	A 135 APC	A 140 EHD / A 120 EHD		
FL FL 220-16	03/2000 -	A 135 APC	A 140 EHD / A 120 EHD		
FL FL 220-17	03/2000 -	A 135 APC	A 140 EHD / A 120 EHD		
FL FL 220-18	03/2000 -	A 135 APC	A 140 EHD / A 120 EHD		
FL FL 220-7,5	03/2000 -	A 135 APC	A 140 EHD / A 120 EHD		

MARCHIO E MODELLO - MAKE AND MODEL MARQUE ET MODÈLE - MARKE UND MODELL MARCA Y MODELO - МАРКА И МОДЕЛЬ	Periodo Period	powerCUBE		energyCUBE	
		APC	EHD	APC	RST
VOLVO cont.					
FL FL 220-8	03/2000 -	A 135 APC	A 140 EHD / A 120 EHD		
FL FL 220-9	03/2000 -	A 135 APC	A 140 EHD / A 120 EHD		
FL FL 250-10	03/2000 -	A 135 APC	A 140 EHD / A 120 EHD		
FL FL 250-11	03/2000 -	A 135 APC	A 140 EHD / A 120 EHD		
FL FL 250-12	03/2000 -	A 135 APC	A 140 EHD / A 120 EHD		
FL FL 250-13	03/2000 -	A 135 APC	A 140 EHD / A 120 EHD		
FL FL 250-14	03/2000 -	A 135 APC	A 140 EHD / A 120 EHD		
FL FL 250-15	03/2000 -	A 135 APC	A 140 EHD / A 120 EHD		
FL FL 250-16	03/2000 -	A 135 APC	A 140 EHD / A 120 EHD		
FL FL 250-17	03/2000 -	A 135 APC	A 140 EHD / A 120 EHD		
FL FL 250-18	03/2000 -	A 135 APC	A 140 EHD / A 120 EHD		
FL FL 250-7,5	03/2000 -	A 135 APC	A 140 EHD / A 120 EHD		
FL FL 250-8	03/2000 -	A 135 APC	A 140 EHD / A 120 EHD		
FL FL 250-9	03/2000 -	A 135 APC	A 140 EHD / A 120 EHD		
FL 10 FL 10/280	09/1985 - 12/1990	A 135 APC	A 140 EHD / A 120 EHD		
FL 10 FL 10/320	12/1995 - 09/1998	A 135 APC	A 140 EHD / A 120 EHD		
FL 10 FL 10/360	12/1995 - 09/1998	A 135 APC	A 140 EHD / A 120 EHD		
FL 10 FL 10H/320	12/1995 - 09/1998	A 135 APC	A 140 EHD / A 120 EHD		
FL 10 FL 10H/360	12/1995 - 09/1998	A 135 APC	A 140 EHD / A 120 EHD		
FL 12 FL 12/380	09/1995 - 09/1998	A 135 APC	A 140 EHD / A 120 EHD		
FL 12 FL 12/420	09/1995 - 09/1998	A 135 APC	A 140 EHD / A 120 EHD		
FL 12 FL 12H/380	09/1995 - 09/1998	A 135 APC	A 140 EHD / A 120 EHD		
FL 12 FL 12H/420	09/1995 - 09/1998	A 135 APC	A 140 EHD / A 120 EHD		
FL 4 FL 408	02/1986 - 10/1989				CB 110 RST
FL 6 FL 608	01/1991 - 09/1998				CB 110 RST
FL 6 FL 608	01/1993 - 09/1998				CB 110 RST
FL 6 FL 608	10/1985 - 09/1998				CB 110 RST
FL 6 FL 610	09/1985 - 11/1994				CB 110 RST
FL 6 FL 611	09/1985 - 09/1998				CB 110 RST
FL 6 FL 611	09/1985 - 11/1994				CB 110 RST
FL 6 FL 611	12/1994 - 09/1998				CB 110 RST
FL 6 FL 612	09/1985 - 09/1998				CB 110 RST
FL 6 FL 612	11/1991 - 09/1998				CB 110 RST
FL 6 FL 612	12/1995 - 09/1998				CB 110 RST
FL 6 FL 614	09/1985 - 09/1998				CB 110 RST
FL 6 FL 614	12/1995 - 09/1998				CB 110 RST
FL 6 FL 615	11/1991 - 09/1998				CB 110 RST
FL 6 FL 615	12/1995 - 09/1998				CB 110 RST
FL 6 FL 618	11/1991 - 09/1998				CB 110 RST
FL 6 FL 618	12/1995 - 09/1998				CB 110 RST
FL 7 FL 7/230	09/1985 - 09/1998	B 180 APC	B 180 EHD	B 185 APC	
FL 7 FL 7/260	11/1991 - 09/1998	B 180 APC	B 180 EHD	B 185 APC	
FL 7 FL 7/290	10/1993 - 09/1998	B 180 APC	B 180 EHD	B 185 APC	
FL II FL 240-12	05/2006 -	B 180 APC	B 180 EHD / B 160 EHD	B 185 APC	
FL II FL 240-14	06/2009 -	B 180 APC	B 180 EHD / B 160 EHD	B 185 APC	

MARCHIO E MODELLO - MAKE AND MODEL MARQUE ET MODÈLE - MARKE UND MODELL MARCA Y MODELO - МАРКА И МОДЕЛЬ	Periodo Period	powerCUBE		energyCUBE	
		APC	EHD	APC	RST
VOLVO					
<i>cont.</i>					
FL II FL 240-15	05/2006 -	B 180 APC	B 180 EHD / B 160 EHD	B 185 APC	
FL II FL 240-16	05/2006 -	B 180 APC	B 180 EHD / B 160 EHD	B 185 APC	
FL II FL 240-16	06/2009 -	B 180 APC	B 180 EHD / B 160 EHD	B 185 APC	
FL II FL 240-18	05/2006 -	B 180 APC	B 180 EHD / B 160 EHD	B 185 APC	
FL II FL 260-12	06/2009 -	B 180 APC	B 180 EHD / B 160 EHD	B 185 APC	
FL II FL 260-14	06/2009 -	B 180 APC	B 180 EHD / B 160 EHD	B 185 APC	
FL II FL 260-15	06/2009 -	B 180 APC	B 180 EHD / B 160 EHD	B 185 APC	
FL II FL 260-16	06/2009 -	B 180 APC	B 180 EHD / B 160 EHD	B 185 APC	
FL II FL 260-18	06/2009 -	B 180 APC	B 180 EHD / B 160 EHD	B 185 APC	
FL II FL 280-12	05/2006 -	B 180 APC	B 180 EHD / B 160 EHD	B 185 APC	
FL II FL 280-14	06/2009 -	B 180 APC	B 180 EHD / B 160 EHD	B 185 APC	
FL II FL 280-15	05/2006 -	B 180 APC	B 180 EHD / B 160 EHD	B 185 APC	
FL II FL 280-16	05/2006 -	B 180 APC	B 180 EHD / B 160 EHD	B 185 APC	
FL II FL 280-18	05/2006 -	B 180 APC	B 180 EHD / B 160 EHD	B 185 APC	
FL II FL 290-12	06/2009 -	B 180 APC	B 180 EHD / B 160 EHD	B 185 APC	
FL II FL 290-14	06/2009 -	B 180 APC	B 180 EHD / B 160 EHD	B 185 APC	
FL II FL 290-16	06/2009 -	B 180 APC	B 180 EHD / B 160 EHD	B 185 APC	
FL II FL 290-18	06/2009 -	B 180 APC	B 180 EHD / B 160 EHD	B 185 APC	
FL III FL 210-12	05/2013 -	B 180 APC	B 180 EHD	B 185 APC	
FL III FL 240-12	05/2013 -	B 180 APC	B 180 EHD	B 185 APC	
FL III FL 250-12	05/2013 -	B 180 APC	B 180 EHD	B 185 APC	
FL III FL 280-12	05/2013 -	B 180 APC	B 180 EHD	B 185 APC	
FL III FLH 240-18	05/2013 -	B 180 APC	B 180 EHD	B 185 APC	
FL III FLH 260-18	05/2013 -	B 180 APC	B 180 EHD	B 185 APC	
FL III FLH 280-18	05/2013 -	B 180 APC	B 180 EHD	B 185 APC	
FL III FLH 290-18	05/2013 -	B 180 APC	B 180 EHD	B 185 APC	
FL III FLL 240-16	05/2013 -	B 180 APC	B 180 EHD	B 185 APC	
FL III FLL 260-16	05/2013 -	B 180 APC	B 180 EHD	B 185 APC	
FL III FLL 290-16	05/2013 -	B 180 APC	B 180 EHD	B 185 APC	
FLC FLC 140	09/1996 - 09/2000				CB 110 RST
FM FM 300		B 180 APC	B 180 EHD	B 185 APC	
FM FM 300	09/2005 -	B 180 APC	B 180 EHD	B 185 APC	
FM FM 330	04/2012 -	B 180 APC	B 180 EHD	B 185 APC	
FM FM 330	09/2005 -	B 180 APC	B 180 EHD	B 185 APC	
FM FM 340	09/2005 -	B 180 APC	B 180 EHD	B 185 APC	
FM FM 360	09/2005 -	B 180 APC	B 180 EHD	B 185 APC	
FM FM 360	11/2005 -	B 180 APC	B 180 EHD	B 185 APC	
FM FM 370	04/2012 -	B 180 APC	B 180 EHD	B 185 APC	
FM FM 370	09/2005 -	B 180 APC	B 180 EHD	B 185 APC	
FM FM 380	04/2012 -	B 180 APC		B 185 APC	
FM FM 380	09/2005 -	B 180 APC	B 180 EHD	B 185 APC	
FM FM 390	06/2008 -	B 180 APC	B 180 EHD	B 185 APC	
FM FM 400	09/2005 -	B 180 APC	B 180 EHD	B 185 APC	
FM FM 410	04/2012 -	B 180 APC	B 180 EHD	B 185 APC	
FM FM 410	09/2005 -	B 180 APC	B 180 EHD	B 185 APC	

MARCHIO E MODELLO - MAKE AND MODEL MARQUE ET MODÈLE - MARKE UND MODELL MARCA Y MODELO - МАРКА И МОДЕЛЬ	Periodo Period	powerCUBE		energyCUBE	
		APC	EHD	APC	RST
VOLVO					
cont.					
FM FM 420	04/2012 -	B 180 APC	B 180 EHD	B 185 APC	
FM FM 420	09/2005 -	B 180 APC	B 180 EHD	B 185 APC	
FM FM 440	09/2005 -	B 180 APC	B 180 EHD	B 185 APC	
FM FM 450	04/2012 -	B 180 APC	B 180 EHD	B 185 APC	
FM FM 450	09/2005 -	B 180 APC	B 180 EHD	B 185 APC	
FM FM 460	04/2012 -	B 180 APC	B 180 EHD	B 185 APC	
FM FM 460	09/2005 -	B 180 APC	B 180 EHD	B 185 APC	
FM FM 480	09/2005 -	B 180 APC	B 180 EHD	B 185 APC	
FM FM 500	04/2012 -	B 180 APC	B 180 EHD	B 185 APC	
FM FM 500	09/2005 -	B 180 APC	B 180 EHD	B 185 APC	
FM FM 500	09/2007 -	B 180 APC	B 180 EHD	B 185 APC	
FM 10 FM 10/320	04/1999 - 12/2001	B 180 APC	B 180 EHD / B 160 EHD	B 185 APC	
FM 10 FM 10/360	04/1999 - 12/2001	B 180 APC	B 180 EHD / B 160 EHD	B 185 APC	
FM 12 FM 12/340	08/1998 - 09/2005	B 180 APC	B 180 EHD / B 160 EHD	B 185 APC	
FM 12 FM 12/380	08/1998 - 09/2005	B 180 APC	B 180 EHD / B 160 EHD	B 185 APC	
FM 12 FM 12/420	08/1998 - 09/2005	B 180 APC	B 180 EHD / B 160 EHD	B 185 APC	
FM 12 FM 12/460	08/1998 - 09/2005	B 180 APC	B 180 EHD / B 160 EHD	B 185 APC	
FM 12 FM 12H/340	08/1998 - 09/2005	B 180 APC	B 180 EHD / B 160 EHD	B 185 APC	
FM 12 FM 12H/380	08/1998 - 09/2005	B 180 APC	B 180 EHD / B 160 EHD	B 185 APC	
FM 12 FM 12H/420	08/1998 - 09/2005	B 180 APC	B 180 EHD / B 160 EHD	B 185 APC	
FM 7 FM 7/250	08/1998 - 12/2001	B 180 APC	B 180 EHD / B 160 EHD	B 185 APC	
FM 7 FM 7/290	08/1998 - 12/2001	B 180 APC	B 180 EHD / B 160 EHD	B 185 APC	
FM 9 FM 9/260	12/2001 - 09/2005	B 180 APC	B 180 EHD / B 160 EHD	B 185 APC	
FM 9 FM 9/300	12/2001 - 09/2005	B 180 APC	B 180 EHD / B 160 EHD	B 185 APC	
FM 9 FM 9/340	12/2001 - 09/2005	B 180 APC	B 180 EHD / B 160 EHD	B 185 APC	
FM 9 FM 9/380	12/2001 - 09/2005	B 180 APC	B 180 EHD / B 160 EHD	B 185 APC	
FMX 330	04/2010 -	B 180 APC	B 180 EHD	B 185 APC	
FMX 330	09/2013 -	B 180 APC	B 180 EHD	B 185 APC	
FMX 370	09/2013 -	B 180 APC	B 180 EHD	B 185 APC	
FMX 380	04/2010 -	B 180 APC	B 180 EHD	B 185 APC	
FMX 380	09/2013 -	B 180 APC	B 180 EHD	B 185 APC	
FMX 400	10/2012 -	B 180 APC		B 185 APC	
FMX 410	09/2013 -	B 180 APC	B 180 EHD	B 185 APC	
FMX 420	09/2013 -	B 180 APC	B 180 EHD	B 185 APC	
FMX 430	09/2013 -	B 180 APC	B 180 EHD	B 185 APC	
FMX 440	10/2012 -	B 180 APC	B 180 EHD	B 185 APC	
FMX 450	09/2013 -	B 180 APC	B 180 EHD	B 185 APC	
FMX 460	09/2013 -	B 180 APC	B 180 EHD	B 185 APC	
FMX 480	10/2012 -	B 180 APC	B 180 EHD	B 185 APC	
FMX 500	09/2013 -	B 180 APC	B 180 EHD	B 185 APC	
FMX 540	09/2013 -	B 180 APC	B 180 EHD	B 185 APC	
FS 7 FS 718	09/1994 - 03/1996	A 135 APC	A 140 EHD / A 120 EHD		
N 10 N 10/270	01/1973 - 12/1989	A 135 APC	A 140 EHD / A 120 EHD		
N 10 N 10/300	01/1973 - 12/1989	A 135 APC	A 140 EHD / A 120 EHD		
N 7 N7	01/1973 - 09/1980	B 180 APC	B 180 EHD	B 185 APC	

MARCHIO E MODELLO - MAKE AND MODEL MARQUE ET MODÈLE - MARKE UND MODELL MARCA Y MODELO - МАРКА И МОДЕЛЬ	powerCUBE		energyCUBE		Altre serie: Other series: TITANIUM CLASSICA MOTORENERGY	N° BTR
	APC	EHD	APC	RST		
ADRIATICA						
MAJORMEC					GR24X 70	1
MASTER					GR24X 70	1
MASTERMEC					GR24X 70	1
AEBI						
TP 20, 20 S7 (S8) (S9)				AT 100 RSTd		1
TP 25, 27, 35, 45 S, 47, 50					L5 90P	1
TP 50 S2, S3, S4, S10				AT 100 RSTd		1
TP 65, 67, 80, 1000					L5 90P	1
TT 33 TERRA TRAC					GR24X 70	1
TT 77					L5 90P	1
TT 88, TT 90					L5 90P	1
TTH 77					L5 90P	1
AGRIA						
4700, 4800, 4900, 5900, 6700					L1 44P	1
6900, 7200.11, 7900, 8300					L1 44P	1
8500, 8900					L2 60P	1
9300					L1 44P	1
9300 E					L2 60P	1
AGRIFULL TOSELLI						
35					L2 60P	1
50, 55, 60, 65					L5 90P	1
68 SC, SUPER					L1X 44	1
70		MT 132 EHD				1
70 C					L5 90P	1
75					L5 90P	1
80		MT 132 EHD				1
80 C					L5 90P	1
80 TORNADO		MC12 120 EHD				1
80.9, DT					L5 90P	1
90 DT, 90 S, 100, 110 DT		MT 132 EHD				1
110 S, 140		MT 132 EHD				1
230 C				G28 100 RST		1
235 C, DT, LL, VIGNETO				G28 100 RST		1

MARCHIO E MODELLO - MAKE AND MODEL MARQUE ET MODÈLE - MARKE UND MODELL MARCA Y MODELO - МАРКА И МОДЕЛЬ	powerCUBE		energyCUBE		Altre serie: Other series: TITANIUM CLASSICA MOTORENERGY	N° BTR
	APC	EHD	APC	RST		
AGRIFULL TOSELLI						
cont.						
345 C, DT, VIGNETO				G28 100 RST		1
350.9 DT					L5 90P	1
355 C, 376				G28 100 RST		1
475, 485		MC15 185 EHD / MC15 160 EHD				1
1000 DT		MT 132 EHD				1
C80.66 L, N		MT 132 EHD				1
DERBY 60				G28 100 RST		1
GRISO					L5 90P	1
JOLLY 345				G28 100 RST		1
PINTO 6115		MC15 185 EHD / MC15 160 EHD				1
PONY 230, 235					GR24X 70	1
RODEO 90, 95		MC12 120 EHD				1
RODEO 95 TURBO		MC15 185 EHD / MC15 160 EHD				1
SPRINT 345					GR24X 70	1
SPRINT 350				G28 100 RST		1
ALLIS CHARMERS						
545 H		D14 148 EHD				1
745 H		C 200 EHD				2
5000				CH 125 RST		1
AC 7580, 8580				CBX 110 RST		1
BTL 10, 12, 14, 16				CB 110 RST		1
BTL 20		D14 148 EHD				1
ED 40				CB 110 RST		1
HD 16 DP		C 200 EHD				2
TL 12, 16, 645				CH 125 RST		1
AMOG TOMISANI						
1220					6DR7M	1
GIAGUARO		MC15 185 EHD / MC15 160 EHD				1
LINCE		MC15 185 EHD / MC15 160 EHD				1
MIETITREBBIA PANTERA		MC15 185 EHD / MC15 160 EHD				1
MILLE MAJOR					6DR7M	1

MARCHIO E MODELLO - MAKE AND MODEL MARQUE ET MODÈLE - MARKE UND MODELL MARCA Y MODELO - МАРКА И МОДЕЛЬ	powerCUBE		energyCUBE		Altre serie: Other series: TITANIUM CLASSICA MOTORENERGY	N° BTR
	APC	EHD	APC	RST		
AMOG TOMISANI						
cont.						
MT 750 SUPER (DEMM)					6DR7M	1
MT 1000 SUPER (PERKINS)					6DR7M	1
T 40 C, DT					L5 90P	1
TIGRE					L5 90P	1
TR 25 R, 30, 32					L5 90P	1
WHITE		MC15 185 EHD / MC15 160 EHD				1
ATLAS COPCO						
35 B, D				AT 100 RSTd		1
58 I/S				AT 100 RSTd		2
75 DBA				AT 100 RSTd		2
75 I/S					M4 132	2
PNS 1200		C 200 EHD				4
VT4 A, RUDB					M4 132	2
VT5 RUDB					M4 132	2
XA 60, 80				CH 125 RST		1
XA 120, 160				CB 110 RST		2
XAS 60, 80				CH 125 RST		1
XAS 120, 160				CB 110 RST		2
XASS 60, 80				CH 125 RST		1
XASS 120, 160				CB 110 RST		2
AXECO						
MACCHINE STRADALI				G28 100 RST		1
BARBIERI						
DELFINO					L1X 44	1
FURIA 2RM, 4RM					GR24X 70	1
GHEPARD					53211	1
IDROTRAC 2/4 HD					E2 45	1
LEOPARD					53211	1
TERATRAC 4GL, 4GLW, 4A					53030	1

MARCHIO E MODELLO - <i>MAKE AND MODEL</i> MARQUE ET MODÈLE - <i>MARKE UND MODELL</i> MARCA Y MODELO - <i>МАРКА И МОДЕЛЬ</i>	powerCUBE		energyCUBE		Altre serie: <i>Other series:</i> TITANIUM CLASSICA MOTORENERGY	N° BTR
	APC	EHD	APC	RST		
BAUTZ						
AS 170, 220, 240				AT 100 RSTd		1
D 12, 14					L5 90P	1
D 45				AT 100 RSTd		1
D 254		D11 135 EHD / D11 110 EHD				1
D 415, 420				G28 100 RST		1
D 416, 527, 532				AT 100 RSTd		1
F 43/8S				AT 100 RSTd		1
T 600					L5 90P	1
T 604				AT 100 RSTd		1
TITAN 1100, 1310				AT 100 RSTd		1
TITAN 1300, 2000					L5 90P	1
BCS						
MOTOFALCIATRICI 268, 622					L1X 44	1
MOTOFALCIATRICI 715, 725					F60-N24AL-B	1
TRATTORI 8443, 8444				G28 100 RST		1
VALIANT 400 AR, RS (Mono) (Rev)					GR24X 70	1
VALIANT 500 AR, RS (Mono) (Rev)					GR24X 70	1
VANGUARD 550 AR, RS (Mono) (Rev)				G28 100 RST		1
VANGUARD 750 AR, FR, MT, RS (Mono) (Rev)				G28 100 RST		1
VANGUARD 800 AR, FR, MT, RS (Mono) (Rev)				G28 100 RST		1
VICTOR 300 AR, RS (Mono)					E2 45	1
VICTOR 400 AR, RS (Mono)					E2 45	1
VITHAR 800 (900) AR Mono				G28 100 RST		1
VITHAR 9800 AR Mono				G28 100 RST		1
VIVID 300 (400) DT					E2 45	1
BELARUS						
410, 411, 415, 416, 425, 430, 447, 450, 451, 455, 456, 457, 465, 470					M6 198	1
507				AT 100 RSTd		1
512					M4 132	1
550, 552					M6 198	1
560, 572				AT 100 RSTd		1
611, 650, 654					M6 198	1
800, 820, 920				AT 100 RSTd		1
940, 944					M6 198	1
BX 80-2, 80-4, 90-2, 90-4					M6 198	1
BX 100-2, 100-4					M6 198	1

MARCHIO E MODELLO - MAKE AND MODEL MARQUE ET MODÈLE - MARKE UND MODELL MARCA Y MODELO - МАРКА И МОДЕЛЬ	powerCUBE		energyCUBE		Altre serie: Other series: TITANIUM CLASSICA MOTORENERGY	N° BTR
	APC	EHD	APC	RST		
BELARUS						
cont.						
MTZ 50, 52, 80, 82					M6 198	2
MTZ 80, 82, 102				AT 100 RSTd		1
MTZ 560, 562					M6 198	2
MTZ 1022					L3 70P	2
MTZ 920 Over					L3 70P	2
MTZ 923 Over					L3 70P	2
MTZ 952 Over					L3 70P	2
MTZ 1020 Over					L3 70P	2
MTZ 1221 Over					L3 70P	2
T 25 A					M4 132	2
T 40, A, AS					M6 198	2
T 54					M6 198	1
T 150, 250					GR24X 70	1
UMZ 611					M6 198	2
BELOTTI						
B52 AC		MC15 185 EHD / MC15 160 EHD				2
B52 ACS, GM					6DR7M	2
B66					6DR7M	2
B69		MC15 185 EHD / MC15 160 EHD				2
B75	CX 225 APC	CX 200 EHD	CX 220 APC			2
B79, 81		MC15 185 EHD / MC15 160 EHD				2
BENATI						
BEN 125B, 165B, 195B		MC12 120 EHD				2
BEN 225B, 255B, 355B, 405B		MC15 185 EHD / MC15 160 EHD				2
BEN CSB 90, 120, 140					6ER10	1
BEN CSB 270, 370					6ER10	
BEN CSB 450, 525, 610					6ER10	2
ESCAVATORE MAX 70 PONY (PERKINS)				G28 100 RST		2
ESCAVATORE MAX 90, MAX 160 (PERKINS)					6DR10P	1
PALA 15GM, 22GM					6DR10P	1
PALA CARICATRICE BEN18 GM (OM)				G28 100 RST		2

MARCHIO E MODELLO - MAKE AND MODEL MARQUE ET MODÈLE - MARKE UND MODELL MARCA Y MODELO - МАРКА И МОДЕЛЬ	powerCUBE		energyCUBE		Altre serie: Other series: TITANIUM CLASSICA MOTORENERGY	N° BTR
	APC	EHD	APC	RST		
BENFRA						
7.08, 9.07, 9.08, 9.09, 9.10, 9.11				G28 100 RST		1
415B				G28 100 RST		1
ESCAVATORE 2RM, 4RM					L2X 60P	2
ESCAVATORE 360					L2X 60P	2
ESCAVATORE 4511S		MC12 120 EHD				2
BERTOLINI						
20, 420 N, 431, 432, 450, 510, 530					L1X 44	1
450 3/C, 2036, 2040				G28 100 RST		1
MOTOCOLTIVATORE BM, BM12					GR24X 70	1
MOTOFALCIATRICE BR58, BR58SS					53211	1
T/412					GR24X 70	1
BUSATTO						
520, 540					GR24X 70	1
B225, 325, 330					L5 90P	1
LAMBDA				G28 100 RST		1
MC20, RS					GR24X 70	1
MC40					GR24X 70	1
MOTOAGRICOLE TRANSPORTER					GR24X 70	1
CARRARO ANTONIO						
BITRAC HS					L3 70P	1
CARRARINO SERIE 43					L1X 44	1
CARRARINO SUPER					L1X 44	1
ERGIT 7400, 9400				G28 100 RST		1
ERGIT SRX 6400, 8400, 9400, 10400				G28 100 RST		1
ERGIT TC 5400, 6400				G28 100 RST		1
ERGIT TF 6400, 7400, 8400, 9400				G28 100 RST		1
ERGIT TGF 7400, 9400, 10400				G28 100 RST		1
ERGIT TN 5400, 6400				G28 100 RST		1
ERGIT TRF 7400, 8400, 9400				G28 100 RST		1
ERGIT TRG 9400, 10400				G28 100 RST		1
ERGIT TRH 9400				G28 100 RST		1
ERGIT TRX 6400, 7400, 8400, 9400, 10400				G28 100 RST		1
ERGIT TTR 6400, 8400, 9400, 10400				G28 100 RST		1

MARCHIO E MODELLO - MAKE AND MODEL MARQUE ET MODÈLE - MARKE UND MODELL MARCA Y MODELO - МАРКА И МОДЕЛЬ	powerCUBE		energyCUBE		Altre serie: Other series: TITANIUM CLASSICA MOTOREENERGY	N° BTR
	APC	EHD	APC	RST		
CARRARO ANTONIO cont.						
MAKI 535, 536 R				G28 100 RST		1
MINI CARRARINO					L1X 44	1
MOTOCOLTIVATORE PLANEMATIC					GR24X 70	1
MOTOCOLTIVATORI CARRARINO 390, 500, 510					L1X 44	1
RONDO' K327, K333					L1 44P	1
SP 4400, 4400 HST					L3 70P	1
SUPERCAR 3200, 3700					L3 70P	1
SUPERCAR 5000, 5500				G28 100 RST		1
SUPERTIGRE 5000					L3 70P	1
SUPERTIGRE 5500, 5500 VIGNETO				G28 100 RST		1
SUPERTIGRE 625, 842				G28 100 RST		1
SUPERTIGRE 7500				G28 100 RST		1
SUPERTRAC HTM				G28 100 RST		1
TIGRE 2000, 2700, 3100, 3200, 3700, 4200					L3 74P	1
TIGRE 4RM					E2 45	1
TIGRE 5000, 5500, 7500, 7700				G28 100 RST		1
TIGRECAR serie18 3100, 3700					L3 70P	1
TIGRECAR 3100, 3200, 3700					L3 70P	1
TIGRECAR 3100 GST, 4300 GST					L3 74P	1
TIGRECAR 5000, 5500				G28 100 RST		1
TIGRECAR CC (PC) (PL) 5500, 6500, 8400				G28 100 RST		1
TIGRE COUNTRY 3700, 4300, 4400					L3 70P	1
TIGRE TRANS					L3 70P	1
TIGRONE 635, 636, 740, 742				G28 100 RST		1
TIGRONE 765 TROPICAL		MC15 185 EHD / MC15 160 EHD				1
TIGRONE 835 R, 836				G28 100 RST		1
TIGRONE 3200, 3700, 4200, 4500					L3 74P	1
TIGRONE 5000, 5400(T), 5500 (S) (TCF) (TNE), 6500 SN (TN), 7500, 7700, 8000, 8400 SX (TCF)(TN)				G28 100 RST		1
TIGRONE ATLAS 746 RS, 750, 750 RS, 765, 766		MC12 120 EHD				1
TIGROTTO TRANS					L3 70P	1
TRATTORI 2800, 4000, 4800					GR24X 70	1
TRATTORI 7000 series				G28 100 RST		1
TTR 4400 HST (Agri)					L3 70P	1
TTR 4400 HST					L3 70P	1
UNICAR					GR24X 70	1
CARRARO SPA						
AGRI PLUS 65, 75, 85 (F) (V)				G28 100 RST		1
4N					L5 90P	1
5.1000, 6.1000, 8.1000					L5 90P	1

MARCHIO E MODELLO - MAKE AND MODEL MARQUE ET MODÈLE - MARKE UND MODELL MARCA Y MODELO - МАРКА И МОДЕЛЬ	powerCUBE		energyCUBE		Altre serie: Other series: TITANIUM CLASSICA MOTORENERGY	N° BTR
	APC	EHD	APC	RST		
CARRARO SPA						
cont.						
48.2, 48.4, 58.2, 58.4				G28 100 RST		1
68.2, 68.4, 78.2, 78.4		MC15 185 EHD / MC15 160 EHD				1
88.2, 88.4, 98.2, 98.4		MC15 185 EHD / MC15 160 EHD				1
118.4, 138.4		MC15 185 EHD / MC15 160 EHD				1
420.5					GR24X 70	1
502 FS, V				G28 100 RST		1
502, 504, 505, 505 CL, 520.5, 534				G28 100 RST		1
602, 604				G28 100 RST		1
605 C, CL, CM				G28 100 RST		1
652, 654		MC15 185 EHD / MC15 160 EHD				1
655 CL, CS				G28 100 RST		1
702, 704					6DR7M	1
720.5				G28 100 RST		1
732, 734		MC15 185 EHD / MC15 160 EHD				1
735, 740, 746, 750, 765, 766				G28 100 RST		1
820.5		MT 132 EHD				1
844		MC15 185 EHD / MC15 160 EHD				1
920.5 TURBO		MT 132 EHD				1
952, 954					6DR7M	1
984		MC15 185 EHD / MC15 160 EHD				1
2700					L3 70P	1
3400, 3600					GR24X 70	1
3500 CL				G28 100 RST		1
3700					L3 70P	1
4000				G28 100 RST		1
4200					L3 70P	1
4400, 4500					GR24X 70	1
4500 CL, 4800, 5000, 5000 CL, 5500				G28 100 RST		1
6000, 6300, 6500, 7000, 7500					6DR7M	1
7700, 8000				G28 100 RST		1
TRATTORE 1020		MC15 185 EHD / MC15 160 EHD				1
CASE IH						
95, 105, 115		B 180 EHD (B03)				1

MARCHIO E MODELLO - MAKE AND MODEL MARQUE ET MODÈLE - MARKE UND MODELL MARCA Y MODELO - МАРКА И МОДЕЛЬ	powerCUBE		energyCUBE		Altre serie: Other series: TITANIUM CLASSICA MOTORENERGY	N° BTR
	APC	EHD	APC	RST		
CASE IH						
cont.						
505, 605		B 180 EHD (B03)				1
655, 755, 855		B 180 EHD (B03)				1
6000, 6100, 6200, 6300, 6400		B 180 EHD (B03)				1
6600, 6800, 6900		B 180 EHD (B03)				1
6250Hi, 6850Hi, 8050Hi, 8950Hi		B 180 EHD (B03)				1
705, 715M, 755,		B 180 EHD (B03)				1
805, 855, 905		B 180 EHD (B03)				1
C10-4		B 180 EHD (B03)				1
CS 58, 63, 68, 75, 78, 86, 94, 110, 120, 130, 150					L5 90P	1
CVX 120, 130, 150, 170	B 180 APC	B 180 EHD	B 185 APC			1
CVX 140, 150, 160, 175 (195) '08-->		MC15 185 EHD				1
CVX 1135, 1145, 1155, 1170, 1190	B 180 APC	B 180 EHD	B 185 APC			1
H800, H810,		B 180 EHD (B03)				1
JX 70 (80) (90) (95) '08-->		MT 132 EHD				1
JX 75 (85) (95) C MAXXIMA				CB 110 RST		1
JX 1070 C (1075 C) (1085 C) (1095 C)				G28 100 RST		1
JX Quantum 85 C (95 C) '08-->				G28 100 RST		1
JXU 70 (80) (90) (100) MAXXIMA				CB 110 RST		1
JXU 85 (95) (105) '08-->		MT 132 EHD				1
JXU 1080 (1090) (1100) --> '07		MT 132 EHD				1
MAXXUM 100 X (110 X) (115 X) (125 X) (140 X) '08-->		MT 132 EHD				1
MXU100, 110, 115, 125, 135				CB 110 RST		1
MXM 120 (130) (140) (155) (170) (190) MAXXUM	B 180 APC	B 180 EHD	B 185 APC			1
PUMA 165 (180) (210) '08-->	B 180 APC	B 180 EHD	B 185 APC			1
S230, S260		B 180 EHD (B03)				1
T120, T130, T140, T160, T170, T180		B 180 EHD (B03)				1
X100, X110, X120		B 180 EHD (B03)				1
CASTELGARDEN						
TRATTORINI RASAERBA					FT19-12B	1
CATERPILLAR						
ESCAVATORI						
304.5				CBX 110 RST		
307B				CBX 110 RST		
312B, BL				CBX 110 RST		2
312C, CL				CBX 110 RST		
315B L				CBX 110 RST		
325B				CBX 110 RST		

MARCHIO E MODELLO - MAKE AND MODEL MARQUE ET MODÈLE - MARKE UND MODELL MARCA Y MODELO - МАРКА И МОДЕЛЬ	powerCUBE		energyCUBE		Altre serie: Other series: TITANIUM CLASSICA MOTORENERGY	N° BTR
	APC	EHD	APC	RST		
CATERPILLAR						
cont.						
350		MC15 185 EHD / MC15 160 EHD				2
375		C 200 EHD				2
5130		MC15 185 EHD / MC15 160 EHD				4
5130B,B ME		MC15 185 EHD				
ESCAVATORI GOMMATI						
M312, M315				CBX 110 RST		
M318 , M320				CBX 110 RST		2
ESCAVATORI VERSIONI SPECIALI						
M318 MH, M320 MH				CBX 110 RST		
320B MH, 325B MH, 330B MH				CBX 110 RST		
325C, C MH				CBX 110 RST		
Skid Stir						
216				CBX 110 RST		1
226, 236				CBX 110 RST		1
246, 248				CBX 110 RST		
PALE GOMMATE / CINGOLATE						
953C, WHA				CBX 110 RST		
963C, WHA				CBX 110 RST		
IT24F				CBX 110 RST		2
902, 906, 908				CBX 110 RST		1
914G				CBX 110 RST		
924G, GZ				CBX 110 RST		2
938F (950F) WHA		MC15 185 EHD / MC15 160 EHD				
950G, 962G				CBX 110 RST		2
970F		MC15 185 EHD / MC15 160 EHD				
980G II				CBX 110 RST		
TERNE						
416D				CBX 110 RST		
420D, D IT				CBX 110 RST		
424D				CBX 110 RST		
428C Turbo				CBX 110 RST		1
428D, 432D, 438D, 438D AWS, 442D, 442D AWS				CBX 110 RST		
MOVIMENTATORI TELESCOPICI						
TH62, 63, 82, 83, 103				CBX 110 RST		
TRATTORI						
D4C		MC15 185 EHD / MC15 160 EHD				
D5M XL, LGP				CBX 110 RST		
D6G				CBX 110 RST		
D6M XL, LGP, WHA				CBX 110 RST		
D6R series II, WHA				CBX 110 RST		

MARCHIO E MODELLO - MAKE AND MODEL MARQUE ET MODÈLE - MARKE UND MODELL MARCA Y MODELO - МАРКА И МОДЕЛЬ	powerCUBE		energyCUBE		Altre serie: Other series: TITANIUM CLASSICA MOTORENERGY	N° BTR
	APC	EHD	APC	RST		
CATERPILLAR						
cont.						
D7G		MC15 185 EHD / MC15 160 EHD				
D7R series II, WHA		MC15 185 EHD / MC15 160 EHD				
D8R, D8R II, WHA				CBX 110 RST		
D9R, D10R, D11R		MC15 185 EHD				2
D9R (D10R) WHA		MC15 185 EHD				
TRATTORI GOMMATI						
814F		MC15 185 EHD / MC15 160 EHD				
824G II				CBX 110 RST		
MOTORSCRAPER						
613C II				CBX 110 RST		
651E, 657E		C 200 EHD				
DUMPER						
777D		MC15 185 EHD				
RULLI COMPATTATORI						
CB-214C, 224C, 224C COMBI				CBX 110 RST		
CB-214D, 224D, 225D COMBI				CBX 110 RST		
CB-334D				CBX 110 RST		
CB-335D COMBI				CBX 110 RST		
CB-434C				CBX 110 RST		1
CB-535B COMBI				CBX 110 RST		1
CB-634C				CBX 110 RST		
CP-433C				CBX 110 RST		
CP-533D, 563D				CBX 110 RST		
CS-433C				CBX 110 RST		
CS-531D, 533D, 563D, 573D, 583D				CBX 110 RST		
816F				CBX 110 RST		2
826G, 826GII				CBX 110 RST		
COMPATTATORI GOMMATI						
PF-300B				CBX 110 RST		1
PS-200B, 300B				CBX 110 RST		1
MOTORGRADER						
120H				CBX 110 RST		
135H		MC15 185 EHD / MC15 160 EHD				
140H				CBX 110 RST		
160H		MC15 185 EHD / MC15 160 EHD				
CIMAS						
COLUMBUS				AT 100 RSTd		1

MARCHIO E MODELLO - MAKE AND MODEL MARQUE ET MODÈLE - MARKE UND MODELL MARCA Y MODELO - МАРКА И МОДЕЛЬ	powerCUBE		energyCUBE		Altre serie: Other series: TITANIUM CLASSICA MOTORENERGY	N° BTR
	APC	EHD	APC	RST		
CIMAS						
cont.						
COMPACT 25					L5 90P	1
CONSUL M					L5 90P	1
D. 38, 48, 66 M, 68				G28 100 RST		1
D. 76 I, 4AL, M		MC12 120 EHD				1
D. 85 I, 4AL, M		MC12 120 EHD				1
D. 86 I, M		MC12 120 EHD				1
D. 96, 96 I		MC12 120 EHD				1
D.105, I		MC15 185 EHD / MC15 160 EHD				1
D.106, I, M		MC15 185 EHD / MC15 160 EHD				1
DOMINATOR		D14 148 EHD				1
JAGUAR		D14 148 EHD				1
MATADOR GIGANT		MC15 185 EHD / MC15 160 EHD				1
MATADOR STANDARD		MC12 120 EHD				1
PROTECTOR					L5 90P	1
SF55		MC12 120 EHD				1
TERNE RIGIDE 9.30, 9.50, 9.70, 9.70 LS		MC15 185 EHD / MC15 160 EHD				1
CLAAS						
ARES 546 (556) (566)				CB 110 RST		1
ARES 547 (557) (567) (577) (597)				CB 110 RST		1
ARES 617 (657)				CB 110 RST		1
ARES 616 (656) (696) RX	B 180 APC	B 180 EHD	B 185 APC			1
ARES 816 (826) (836) RZ	B 180 APC	B 180 EHD	B 185 APC			1
ARION 510 (520) (530) (540)	B 180 APC	B 180 EHD	B 185 APC			1
ARION 610 (620) (630) (640)	B 180 APC	B 180 EHD	B 185 APC			1
ATLES 926 (936) (946)	B 180 APC	B 180 EHD	B 185 APC			1
AXION 810 (820) (830) (840) (850)	B 180 APC	B 180 EHD	B 185 APC			1
CELTIS 426 (436) (446) (456)				CB 110 RST		1
CLASSIC 78, 88, 98, 108	A 135 APC	A 120 EHD / A 140 EHD				1
COLUMBUS (Diesel)				AT 100 RSTd		1
COMET Diesel				AT 100 RSTd		1
COMMANDOR 112, 114, 115, 116, 228	A 135 APC	A 120 EHD / A 140 EHD				1
COMPACT 25, 30					L5 90P	2
CONSUL	A 135 APC	A 120 EHD / A 140 EHD				1

MARCHIO E MODELLO - MAKE AND MODEL MARQUE ET MODÈLE - MARKE UND MODELL MARCA Y MODELO - МАРКА И МОДЕЛЬ	powerCUBE		energyCUBE		Altre serie: Other series: TITANIUM CLASSICA MOTORENERGY	N° BTR
	APC	EHD	APC	RST		
CLAAS						
cont.						
CORSAIR	A 135 APC	A 120 EHD / A 140 EHD				1
COSMOS	A 135 APC	A 120 EHD / A 140 EHD				1
DOMINATOR 38, 48, 58					L5 90P	1
DOMINATOR 66, 68, 76, 78, 80	A 135 APC	A 120 EHD / A 140 EHD				1
DOMINATOR 85, 86, 88, 96, 98	A 135 APC	A 120 EHD / A 140 EHD				1
DOMINATOR 100, 105, 106, 108	B 180 APC	B 180 EHD / B 160 EHD	B 185 APC			1
DOMINATOR 112, 114, 115, 116, 218 (Mega)	A 135 APC	A 120 EHD / A 140 EHD				1
EUROPA D	A 135 APC	A 120 EHD / A 140 EHD				1
JAGUAR 60, 70, 80, 675, 680, 682, 685	A 135 APC	A 120 EHD / A 140 EHD				1
JAGUAR 690, 695	A 135 APC	A 120 EHD / A 140 EHD				2
MATADOR, MATADOR GIGANT	A 135 APC	A 120 EHD / A 140 EHD				1
MAXI	A 135 APC	A 120 EHD / A 140 EHD				1
MERCATOR 50					L5 90P	1
MERCATOR 60, 70, 75	A 135 APC	A 120 EHD / A 140 EHD				1
MERCUR	A 135 APC	A 120 EHD / A 140 EHD				1
NECTIS 227 (237) (247) (257) (267)				G28 100 RST		1
PROTECTOR	A 135 APC	A 120 EHD / A 140 EHD				1
SENATOR	A 135 APC	A 120 EHD / A 140 EHD				1
XERION 3300 (SADDL TRAC)					L5 100P	2
DAVID BROWN						
25D, 30DT, 250D					M4 132	2
770, 880D, 885				CB 110 RST		1
950D					M4 132	2
990D, 995, 1190				CB 110 RST		1
1210, 1212		MC12 120 EHD				1

MARCHIO E MODELLO - MAKE AND MODEL MARQUE ET MODÈLE - MARKE UND MODELL MARCA Y MODELO - МАРКА И МОДЕЛЬ	powerCUBE		energyCUBE		Altre serie: Other series: TITANIUM CLASSICA MOTORENERGY	N° BTR
	APC	EHD	APC	RST		
DAVID BROWN						
cont.						
1270 AK		MC15 185 EHD / MC15 160 EHD				1
1290, 1390				CB 110 RST		1
1410.1		MC15 185 EHD / MC15 160 EHD				1
1490 CS, 4 RM CS, HYSCS		MC15 185 EHD / MC15 160 EHD				1
1690 CS, 4 RM CS, HYSCS		MC15 185 EHD / MC15 160 EHD				1
DE NARDI						
TRATTORE DN3800 4 RM				G28 100 RST		1
DEUTZ-FAHR						
3.30F, 3.50F, 3.70F	A 135 APC	A 120 EHD / A 140 EHD				1
3.30V, 3.50X, 3.70V				AT 100 RSTd		1
3.50S, 3.90S, 3.90F	A 135 APC	A 120 EHD / A 140 EHD				1
600, 660, 750, 770, 922, 980 (MD)					L5 90P	1
1000, 1002 (MD), 1080, 1102				AT 100 RSTd		1
1200, 1202 (MD)				AT 100 RSTd		1
1300, 1320, 1322, 1600	A 135 APC	A 120 EHD / A 140 EHD				1
1620, 1630 (MD)	A 135 APC	A 120 EHD / A 140 EHD				1
2807				AT 100 RSTd		1
2385, 2480 (MD)					L5 90P	1
2580, 2680, 2685, 2780 (MD)	A 135 APC	A 120 EHD / A 140 EHD				1
3607				AT 100 RSTd		1
3330, 3360, 3480, 3570, 3580	A 135 APC	A 120 EHD / A 140 EHD				1
3610, 3630, 3640 (MD), 4005	A 135 APC	A 120 EHD / A 140 EHD				1
4006				AT 100 RSTd		1
4056, 4060, 4065, 4070, 4075	A 135 APC	A 120 EHD / A 140 EHD				1

MARCHIO E MODELLO - MAKE AND MODEL MARQUE ET MODÈLE - MARKE UND MODELL MARCA Y MODELO - МАРКА И МОДЕЛЬ	powerCUBE		energyCUBE		Altre serie: Other series: TITANIUM CLASSICA MOTORENERGY	N° BTR
	APC	EHD	APC	RST		
DEUTZ-FAHR <small>cont.</small>						
4080, 4090 (MD), 4505	A 135 APC	A 120 EHD / A 140 EHD				1
5005	B 180 APC	B 180 EHD / B 160 EHD	B 185 APC			1
5506, 6005	A 135 APC	A 120 EHD / A 140 EHD				1
5006, 5007, 5206, 5505, 6007				AT 100 RSTd		1
6206, 6207, 6507, 6806, 6807	A 135 APC	A 120 EHD / A 140 EHD				1
7007, 7206, 7207	A 135 APC	A 120 EHD / A 140 EHD				1
7506	B 180 APC	B 180 EHD / B 160 EHD	B 185 APC			1
7807	A 135 APC	A 120 EHD / A 140 EHD				1
8005, 9005	B 180 APC	B 180 EHD / B 160 EHD	B 185 APC			1
16006	B 180 APC	B 180 EHD / B 160 EHD	B 185 APC			1
AGROCOMPACT 3.30, 3.50, 3.70, 3.90				AT 100 RSTd		1
AGROCOMPACT F60, F70, F80, F90, F100					L5 90P	1
AGROKID 3.25 HYDRO					L3 70P	1
AGROKID 4.35, 4.45					L3 70P	1
AGROKID 210 (220) (230)					L3 70P	1
AGROLUX 60 DT, 70 DT				G28 100 RST		1
AGROLUX 57 (67)				G28 100 RST		1
AGROLUX F 57 (67)				G28 100 RST		1
AGROFARM 85 (100)					L5 100P	1
AGROPLUS 60				G28 100 RST		1
AGROPLUS 75 (85) (95)		MC12 120 EHD				1
AGROPLUS 100		MC15 185 EHD / MC15 160 EHD				1
AGROPLUS F 70 (75) (90) (100)					L5 100P	1
AGROPLUS S 70 (75) (90) (100)					L5 100P	1
AGROPRIMA 4.31, 4.51, 4.56, 6.06, 6.16	A 135 APC	A 120 EHD / A 140 EHD				1
AGROSTAR 3.57, 4.07, 4.17, 4.61, 4.68, 4.71, 4.78	A 135 APC	A 120 EHD / A 140 EHD				1
AGROSTAR 6.08, 6.11, 6.21, 6.28, 6.31, 6.38	A 135 APC	A 120 EHD / A 140 EHD				1
AGROSTAR 6.61, 6.71, 6.81, 8.31	A 135 APC	A 120 EHD / A 140 EHD				1
AGROSUN		MC12 120 EHD				1
AGROTRON 80, 90, 100, 110		D14 148 EHD				1
AGROTRON 85, 105		D14 148 EHD				1

MARCHIO E MODELLO - MAKE AND MODEL MARQUE ET MODÈLE - MARKE UND MODELL MARCA Y MODELO - МАРКА И МОДЕЛЬ	powerCUBE		energyCUBE		Altre serie: Other series: TITANIUM CLASSICA MOTORENERGY	N° BTR
	APC	EHD	APC	RST		
DEUTZ-FAHR						
	cont.					
AGROTRON 200 (215) (265)	B 180 APC	B 180 EHD	B 185 APC			1
AGROTRON K90 (K100) (K110) (K120)		MC15 185 EHD / MC15 160 EHD				1
AGROTRON MK3 85 (100) (105) (115)		D14 148 EHD				1
AGROTRON TTV 1130 (1145) (1160) -->'06		D14 148 EHD				1
AGROTRON TTV 1130 (1145) (1160) '07-->	B 180 APC	B 180 EHD	B 185 APC			1
AGROTRON X 710 (X 720)	B 180 APC	B 180 EHD	B 185 APC			1
AGROXTRA 4.57	A 135 APC	A 120 EHD / A 140 EHD				1
AGROXTRA 6.07, 6.17	B 180 APC	B 180 EHD / B 160 EHD	B 185 APC			1
D 15, 17, 22P, 25/2, 30S				AT 100 RSTd		1
D 25, 30, 270	A 135 APC	A 120 EHD / A 140 EHD				1
D 40L, 45L					M4 132	2
D 40S	CX 225 APC	CX 200 EHD	CX 220 APC			1
D 177					M4 132	2
D 400, 540	CX 225 APC	CX 200 EHD	CX 220 APC			1
D 2003, 2004		D11 135 EHD / D11 110 EHD				1
D 2005, 2006		D14 148 EHD				1
D 2505, 2506, 3005, 3006				AT 100 RSTd		1
D 4005/6	A 135 APC	A 120 EHD / A 140 EHD				1
D 4007, 4506, 4507, 4807				AT 100 RSTd		1
D 5005		D14 148 EHD				1
D 5006	A 135 APC	A 120 EHD / A 140 EHD				1
D 5207				AT 100 RSTd		1
D 5506, 6006		D14 148 EHD				1
D 7006, 8006	A 135 APC	A 120 EHD / A 140 EHD				1
D 9006, 10006, 13006		D14 148 EHD				1
DX 3.10 , 3.50, 3.90					L5 90P	1
DX 3.30, 3.60, 3.65				AT 100 RSTd		1
DX 3.70	A 135 APC	A 120 EHD / A 140 EHD				1
DX 4.10		D14 148 EHD				1
DX 4.30, 4.31, 4.50, 4.51, 4.61, 4.70	A 135 APC	A 120 EHD / A 140 EHD				1
DX 4.71, 6.05, 6.10, 6.11, 6.30	A 135 APC	A 120 EHD / A 140 EHD				1
DX 6.31, 6.50, 6.61, 7.10	B 180 APC	B 180 EHD / B 160 EHD	B 185 APC			1

MARCHIO E MODELLO - MAKE AND MODEL MARQUE ET MODÈLE - MARKE UND MODELL MARCA Y MODELO - МАРКА И МОДЕЛЬ	powerCUBE		energyCUBE		Altre serie: Other series: TITANIUM CLASSICA MOTORENERGY	N° BTR
	APC	EHD	APC	RST		
DEUTZ-FAHR						
cont.						
DX 8.30	A 135 APC	A 120 EHD / A 140 EHD				1
DX 36	A 135 APC	A 120 EHD / A 140 EHD				1
DX 40		D14 148 EHD				1
DX 50, 80, 85, 86, 90, 92, 100, 110, 120, 140, 145	A 135 APC	A 120 EHD / A 140 EHD				1
DX 160, 230		D14 148 EHD				1
DX 250	A 135 APC	A 120 EHD / A 140 EHD				1
F2L 514					M4 132	2
F2L 612/5/6				AT 100 RSTd		1
INTRAC 2002, A					L5 90P	1
INTRAC 2003, 2004	A 135 APC	A 120 EHD / A 140 EHD				1
M33.60, M34.80, M35.40, M35.78	A 135 APC	A 120 EHD / A 140 EHD				1
SFH.300, 410, 3008, 4000	A 135 APC	A 120 EHD / A 140 EHD				1
EBRO						
6070, 6075, 6080				CH 125 RST		1
EICHER						
3153, 3253, 3353, 3354				CBX 110 RST		1
3704.1, 3705, 3711.12, 3713					L2 60P	1
MAMMUT				AT 100 RSTd		1
PUMA				G28 100 RST		1
F.LLI DIECI						
BETONIERE				G28 100 RST		1

MARCHIO E MODELLO - MAKE AND MODEL MARQUE ET MODÈLE - MARKE UND MODELL MARCA Y MODELO - МАРКА И МОДЕЛЬ	powerCUBE		energyCUBE		Altre serie: Other series: TITANIUM CLASSICA MOTORENERGY	N° BTR
	APC	EHD	APC	RST		
FAI						
750, 900, 1000, 1100, 1300, 1600		MC15 185 EHD / MC15 160 EHD				1
ESCAVATORI 750, 900 C					6ER10	1
ESCAVATORI 900 CH, GTH		MC15 185 EHD / MC15 160 EHD				1
ESCAVATORI 1000 C					6ER10	1
ESCAVATORI 1000 CH, 1000 GTH				G28 100 RST		1
ESCAVATORI 1100 GTV, 1300 CH, 1600 C				G28 100 RST		1
MINIESCAV. FAI 212, 222, 235, 240					GR24X 70	1
PALA ARTICOLATA 555, 556		MC12 120 EHD				1
PALA ARTICOLATA 575, 585, 590, 595		MC15 185 EHD / MC15 160 EHD				1
PANDA 320B, 330B					GR24X 70	1
PANDA 335, 338, 340				G28 100 RST		1
PANDA 380 SC		MC12 120 EHD				1
TERNE 67C, 87D, 87DT, 90B, 90E		MC15 185 EHD / MC15 160 EHD				1
TERNE 96D, 96DT, 96E 266D		MC15 185 EHD / MC15 160 EHD				1
TERNE 100D, 100DT, 264D		MC15 185 EHD / MC15 160 EHD				1
FENDT						
200, 201, 203, 204, 205, 240					L5 90P	1
250, 260, 270, 275, 280, 304					L5 90P	1
300 Ci					L5 90P	1
305, 306, 308, 309		D11 135 EHD / D11 110 EHD				1
307					L5 90P	1
307 Ci , 308 Ci ('07-->)					L5 100P	1
309 Vario, 310 Vario, 311 Vario, 312 Vario ('07-->)					L5 100P	1
411 Vario, 412 Vario, 413 Vario, 414 Vario, 415 Vario ('07-->)					L5 100P	1
711 (712) (714) (716) VARIO	B 180 APC	B 180 EHD	B 185 APC			1
712 Vario, 714 Vario, 716 Vario, 718 Vario ('07-->)	B 180 APC	B 180 EHD	B 185 APC			1
815 (817) (818) VARIO	B 180 APC	B 180 EHD	B 185 APC			1
818 Vario, 820 Vario ('07-->)	B 180 APC	B 180 EHD	B 185 APC			1
922 Vario, 924 Vario, 927 Vario, 930 Vario, 933 Vario, 936 Vario ('07-->)	B 180 APC	B 180 EHD	B 185 APC			1
F 108 LS, LSDT, SDT					L5 90P	1
F 200 S, SDT, V, VDT					L3 70P	1
F 203 P, PDT, V, VDT					L5 90P	1
F 204 PDT					L5 90P	1
F 231 G					L3 70P	1

MARCHIO E MODELLO - MAKE AND MODEL MARQUE ET MODÈLE - MARKE UND MODELL MARCA Y MODELO - МАРКА И МОДЕЛЬ	powerCUBE		energyCUBE		Altre serie: Other series: TITANIUM CLASSICA MOTORENERGY	N° BTR
	APC	EHD	APC	RST		
FENDT						
	cont.					
F 250 GF, 255 GT, 275 GT, 380 GT					L5 90P	1
F 370 GT					L5 90P	1
F 380 GTA					L5 90P	1
FARMER 1					L2 60P	1
FARMER 1D, 1E, 2N, 2S					L3 70P	1
FARMER 2				AT 100 RSTd		1
FARMER 2 D, DE, E					L5 90P	1
FARMER 3S, 4S, 5S					L5 90P	1
FARMER 12				AT 100 RSTd		1
FARMER 25, 102					L2 60P	1
FARMER 131, 139				AT 100 RSTd		1
FARMER 225, 230				AT 100 RSTd		1
FARMER 102S, 103S, 104S, 105S, 106S					L5 90P	1
FARMER 108 S		D11 135 EHD / D11 110 EHD				1
FARMER 162, 168, 178, 186, 192, 198		D11 135 EHD / D11 110 EHD				1
FARMER 204					L5 90P	1
FARMER 200 S, 250 S, 260 S, 280 S					L5 90P	1
FARMER 250 V, 260 V, 270 V, 280 V					L5 90P	1
FARMER 280 P					L5 90P	1
FARMER 303, 304					L5 90P	1
FARMER 305 LSA, 307 LSA, 309 LSA		D11 135 EHD				1
FARMER 307 C, 308 C, 309 C					L5 90P	1
FARMER VARIO 409, 410, 411, 412					L5 90P	1
FAVORIT 2, 3				AT 100 RSTd		1
FAVORIT 3S, 4S					L5 90P	1
FAVORIT 4, 10, 11, 12					L3 70P	2
FAVORIT 312, 510, 512, 514, 600 LS, 600 LSDT		D11 135 EHD				1
FAVORIT 610, 610 LS, 610 LSDT, 611		D11 135 EHD				1
FAVORIT 611 LSA		D14 148 EHD				1
FAVORIT 612LS, 614LS		D14 148 EHD				1
FAVORIT 612, 614, 615, 615 S, 622, 626		D11 135 EHD				1
FAVORIT 711 (712) (714) (716) VARIO		D11 135 EHD				1
FAVORIT 816, 818, 822, 824					L5 90P	2
FAVORIT 916 (920) (924) (926) VARIO					L5 90P	2
GT 115, 220, 230, 225, 231, 250					L5 90P	1
GT 255, 275		D11 135 EHD / D11 110 EHD				1
GT 345, 360, 365, 380					L5 90P	1
GT 390, 395		D11 135 EHD / D11 110 EHD				1
XYLON 520, 522, 524					L3 70P	2

MARCHIO E MODELLO - MAKE AND MODEL MARQUE ET MODÈLE - MARKE UND MODELL MARCA Y MODELO - МАРКА И МОДЕЛЬ	powerCUBE		energyCUBE		Altre serie: Other series: TITANIUM CLASSICA MOTORENERGY	N° BTR
	APC	EHD	APC	RST		
FERRARI SPA						
cont.						
COBRAM 40 AR, RS (Mono) (Rev)					GR24X 70	1
COBRAM 50 AR, RS (Mono) (Rev)					GR24X 70	1
MOTOAGRICOLE 1.1, 1.2					L3 70P	1
MOTOCOLTIVATORE 72, 72S, 74, 75, 75RS, 76, 92/2, 95/33, T72					L1X 44	1
RAPTOR 30 (40) DT					E2 45	1
SYSTEM 55 AR, RS (Mono) (Rev)				G28 100 RST		1
SYSTEM 75 AR, RS (Mono) (Rev)				G28 100 RST		1
SYSTEM 75 FR, MT (Rev)				G28 100 RST		1
SYSTEM 80 AR, RS (Mono) (Rev)				G28 100 RST		1
SYSTEM 80 FR, MT (Rev)				G28 100 RST		1
THOR 70 (90) AR Mono				G28 100 RST		1
THOR 870 AR Mono				G28 100 RST		1
TRATTORE 18.3, 22.3W, 30.4, 75, 75DVA, 75RD, 85, 86, 86RS, 94TR, 95RS, T93					L1X 44	1
TRATTORINI 95, 95 RS, 96					L3 70P	1
VIPAR 30 AR, RS (Mono)					E2 45	1
VIPAR 40 AR, RS (Mono)					E2 45	1
FIAT AGRI						
35.66					L5 90P	1
45.66					L5 90P	1
55.46, 55.65, 55.66, 55.76					L5 90P	1
60.66					L5 90P	1
65.66, 65.88, 65.90, 65.94					L5 90P	1
70.65, 70.66, 70.86, 70.88, 70.90					L5 90P	1
80 R		MC15 185 EHD / MC15 160 EHD				1
80.66		MT 132 EHD				1
80.65, 80.76, 80.88, 80.90, 82.86					L5 90P	1
85.90, 88.94, 90.90					L5 90P	1
90.90 DT		MT 132 EHD				1
96.30					L5 90P	2
100/90 DT, 115/80 DT		MT 132 EHD				1
115.90					L5 90P	1
125, 130		MC15 185 EHD / MC15 160 EHD				1
130.90		MT 132 EHD				1
160.90 DT, 180.90		MC15 185 EHD				1
250, 300, 300 DT, 350, 350 DT, 355				G28 100 RST		1
420 DT					L5 90P	1
446		MT 132 EHD				1
450 vari modelli		MC12 120 EHD				1
455		MC12 120 EHD				1

MARCHIO E MODELLO - MAKE AND MODEL MARQUE ET MODÈLE - MARKE UND MODELL MARCA Y MODELO - МАРКА И МОДЕЛЬ	powerCUBE		energyCUBE		Altre serie: Other series: TITANIUM CLASSICA MOTORENERGY	N° BTR
	APC	EHD	APC	RST		
FIAT AGRI <small>cont.</small>						
455 C		MT 132 EHD				1
460, 470					L5 90P	1
480, DT		MC12 120 EHD				1
500, 500 DT, 505 C		MT 132 EHD				1
505, 570					L5 90P	1
540, DT		MT 132 EHD				1
550, 555		MC15 185 EHD / MC15 160 EHD				1
580		MT 132 EHD				1
600, DT		MC15 185 EHD / MC15 160 EHD				1
605 C		MT 132 EHD				1
605, 640					L5 90P	1
615, DT		MC15 185 EHD / MC15 160 EHD				1
640 DT		MT 132 EHD				1
650, 655		MC15 185 EHD / MC15 160 EHD				1
670					L5 90P	1
680, DT		MT 132 EHD				1
780					L5 90P	1
800		MC15 185 EHD / MC15 160 EHD				1
805					L5 90P	1
850		MC15 185 EHD / MC15 160 EHD				1
850 DT		MT 132 EHD				1
880					L5 90P	1
980 DT		MT 132 EHD				1
980, 1000, 1000 DT		MC15 185 EHD / MC15 160 EHD				1
1180		MT 132 EHD				1
1300 SUPER	CX 225 APC	CX 200 EHD	CX 220 APC			1
1300, DT		MC15 185 EHD / MC15 160 EHD				1
1380		MT 132 EHD				1
1580 DT, 1880		MC15 185 EHD				1
F 100	A 135 APC	A 120 EHD / A 140 EHD				1
F 110, 120, 130		MT 132 EHD				1
G 170		D11 135 EHD / D11 110 EHD				1
L 75, 95		D11 135 EHD / D11 110 EHD				1

MARCHIO E MODELLO - MAKE AND MODEL MARQUE ET MODÈLE - MARKE UND MODELL MARCA Y MODELO - МАРКА И МОДЕЛЬ	powerCUBE		energyCUBE		Altre serie: Other series: TITANIUM CLASSICA MOTORENERGY	N° BTR
	APC	EHD	APC	RST		
FIAT AGRI						
L 521, 624	B 180 APC	B 180 EHD / B 160 EHD	B 185 APC			1
MX 240, 300	B 180 APC	B 180 EHD / B 160 EHD	B 185 APC			1
SUPER 500, 880		MT 132 EHD				1
TRATTORINI 95, 96 RS				G28 100 RST		1
FIAT ALLIS						
7 D				G28 100 RST		2
10 B, 14 B		MC15 185 EHD / MC15 160 EHD				2
65 B				G28 100 RST		2
A4 D		MC12 120 EHD				2
AD 5, 7		MC12 120 EHD				2
AD 8				G28 100 RST		2
AD 9		MC12 120 EHD				2
BD 7		MC12 120 EHD				2
BD 8				G28 100 RST		2
BD 9		MC12 120 EHD				2
BD 20	CX 225 APC	CX 200 EHD	CX 220 APC			2
FA 120				G28 100 RST		2
FB 7				G28 100 RST		2
FBL 4M					L2X 60P	2
FD 5					GR24X 70	2
FD 7, 9				G28 100 RST		2
FD 14		MC15 185 EHD / MC15 160 EHD				2
FD 20		MC15 185 EHD				2
FE 12, R					GR24X 70	2
FE 14, 16, 18				G28 100 RST		2
FE 20		MC15 185 EHD				2
FE 28		MC15 185 EHD / MC15 160 EHD				2
FL 4 L, M					GR24X 70	2
FL 4, C, D		MC12 120 EHD				2
FL 5, 6, 7				G28 100 RST		2
FL 7 C		MC12 120 EHD				2
FL 8 C		MT 132 EHD				2
FL 9				G28 100 RST		2
FL 10 B, C		MC15 185 EHD / MC15 160 EHD				2

MARCHIO E MODELLO - MAKE AND MODEL MARQUE ET MODÈLE - MARKE UND MODELL MARCA Y MODELO - МАРКА И МОДЕЛЬ	powerCUBE		energyCUBE		Altre serie: Other series: TITANIUM CLASSICA MOTORENERGY	N° BTR
	APC	EHD	APC	RST		
FIAT ALLIS						
cont.						
FL 14 B, C, D		MC15 185 EHD / MC15 160 EHD				2
FL 20		MC15 185 EHD				2
FR 7					GR24X 70	2
FR 10, 12				G28 100 RST		2
FR 15		MC15 185 EHD / MC15 160 EHD				2
FR 20				G28 100 RST		2
HD/6		MC15 185 EHD / MC15 160 EHD				2
S 9				G28 100 RST		2
S 11		MC12 120 EHD				2
S 15 B		MC15 185 EHD / MC15 160 EHD				2
S 60				G28 100 RST		2
S 90, 105		MC12 120 EHD				2
SL 9				G28 100 RST		2
SL 11		MC12 120 EHD				2
SR 9				G28 100 RST		2
SR 70		MC12 120 EHD				2
T 44 C, D		MT 132 EHD				2
T 360, 460	CX 225 APC	CX 200 EHD	CX 220 APC			2
TL 10, 12, 14, 16, 20		MC15 185 EHD / MC15 160 EHD				2
TL 30, 40, 160, 260	CX 225 APC	CX 200 EHD	CX 220 APC			2
TL 545, 546, 562, 645	CX 225 APC	CX 200 EHD	CX 220 APC			2
TS 160, 260	CX 225 APC	CX 200 EHD	CX 220 APC			2
FIAT HITACHI						
FH 120, 150W					L3 70P	2
FH 200				G28 100 RST		2
FH 220		MC15 185 EHD / MC15 160 EHD				2
FH 400		MC15 185 EHD				2
FIorentini						
AUTOGRU F250, 450S					L5 90P	1
AUTOGRU F490A		MC15 185 EHD / MC15 160 EHD				1

MARCHIO E MODELLO - <i>MAKE AND MODEL</i> MARQUE ET MODÈLE - <i>MARKE UND MODELL</i> MARCA Y MODELO - <i>МАРКА И МОДЕЛЬ</i>	powerCUBE		energyCUBE		Altre serie: <i>Other series:</i> TITANIUM CLASSICA MOTORENERGY	N° BTR
	APC	EHD	APC	RST		
FIORI						
AIRONE 2000, 3000		MT 132 EHD				1
BETONIERA AIRONE 3500 (->'83)					6DR7M	1
BETONIERA DB150				G28 100 RST		1
BETONIERA DB200.E, 250.E, 350.E, 400.E		MT 132 EHD				1
DUMPER DIESEL ABX, 180, NPX, R.I.					L2X 60P	1
PALE ARTICOLATE AL300, AL400					L2X 60P	1
PALE ARTICOLATE AL500, AL600				G28 100 RST		1
TERNE FA28, 30, 38					L2X 60P	1
FORD						
1710				G28X RST		1
1910, 1920				ATX 100RSTd		1
2000				AT 100 RSTd		1
2110, 2120				ATX 100RSTd		1
2205, 2305				CB 110 RST		1
2610				ATX 100RSTd		1
3000				AT 100 RSTd		1
3230, 3430, 3910, 3930				CB 110 RST		1
4000, 4100, 4600, 4610				MC 130 RST		1
4130, 4630, 4830, 5000		D14 148 EHD				1
5000, 5600, 5610				MC 130 RST		1
5030, 5640				CB 110 RST		1
6410		D14 148 EHD				1
6600, 6610, 6700, 7600				MC 130 RST		1
6640, 7740				CB 110 RST		1
8260, 8360					L2 60P	2
8700, 9700				MC 130 RST		1
DDN					6ER10	1
DEXTA				G28 100 RST		1
FW - vari modelli				G28 100 RST		1
SUPER DEXTA				G28 100 RST		1
SUPER DEXTA 3.6				AT 100 RSTd		1
FOREDIL						
5.13					GR24X 70	1
10.13, 20.13 ('93->)				G28X RST		1
10.13, 20.13 (->'92)					L5 90P	1
23.08		MC15 185 EHD / MC15 160 EHD				1

MARCHIO E MODELLO - MAKE AND MODEL MARQUE ET MODÈLE - MARKE UND MODELL MARCA Y MODELO - МАРКА И МОДЕЛЬ	powerCUBE		energyCUBE		Altre serie: Other series: TITANIUM CLASSICA MOTORENERGY	N° BTR
	APC	EHD	APC	RST		
FOREDIL						
cont.						
30.13, 40.13 ('93->)					GR24X 70	2
30.13, 40.13 (Perkins) (->'92)		MC15 185 EHD / MC15 160 EHD				1
521, 526, 528, 532					GR24X 70	1
602, 604, 652, 654, 662, 664				G28 100 RST		1
719, 919, 921, 926, 928					GR24X 70	1
930, 932, 933 RS, 933 TD					GR24X 70	1
936, 938, 1038, 1040, 1045,				G28 100 RST		1
3000 K, 3050, 3070 (->'97)				G28 100 RST		1
GOLDONI						
900 serie (-> '97)					GR24X 70	1
3000 (Vigneto) serie (-> '97)				G28 100 RST		1
3050 (S)					L3X 74P	1
3050, 3070 (STAR)					L3X 74P	1
3445					L3X 74P	1
3450, 3460				G28 100 RST		1
ASTER 35, 40					L1 44P	1
ASTER 45					L3 74P	1
BASE 20 (EVO)					L1 44P	1
C45, C60					GR24X 70	1
C 55, C 75					L3X 74P	1
CLUSTER 65 (75) RS (SN)					L3 74P	1
EURO serie (->'97)				G28X RST		1
EURO 26 (30) RS (EVO)					L1 44P	1
EURO 30 (40) SN					L1 54P	1
EURO 42 AW					L1 44P	1
EURO 45 RS (SN EVO) ('07-->)					L3 74P	1
EURO 50 A					L1 44P	1
EURO W 40 RS					L1 54P	1
EURO W 45 RS					L3X 74P	1
GM 4.30				AT 100 RSTd		1
GM 4, 14, 18, 20					L1 44P	1
IDEA 26, 30, 30 HST, 40					L1 44P	1
MAXTER W60 RS(SN), 70 REV (RS)(SN)					L3X 74P	1
STAR 50, 70					L3X 74P	1
STAR 65, 75				G28 100 RST		1
STAR 75, 85, 100 QUADRIFOGLIO				G28 100 RST		1
STAR 3050 NRG					L1 54P	1
STAR 3050 (SL), 3060 LC, 3070 (V) ('07-->)					L3 74P	1
STAR 3070 V (NRG)					L3X 74P	1
STAR 4000 QUADRIFOGLIO				G28 100 RST		1

MARCHIO E MODELLO - MAKE AND MODEL MARQUE ET MODÈLE - MARKE UND MODELL MARCA Y MODELO - МАРКА И МОДЕЛЬ	powerCUBE		energyCUBE		Altre serie: Other series: TITANIUM CLASSICA MOTORENERGY	N° BTR
	APC	EHD	APC	RST		
GOLDONI						
cont.						
TRANSCAR serie (->'97)				G28X RST		1
TRANSCAR 22RS					L1 44P	1
TRANSCAR 25 - W60					L3X 74P	1
TRANSCAR 28 SN (RS)					L3X 74P	1
TRANSCAR W33, 40, 60, 70 SN (RS)					L3X 74P	1
TRANSPORTER 336				AT 100 RSTd		1
TRATTORI COMPACT				G28 100 RST		1
UNIVERSAL 233, 238, 245				G28 100 RST		1
UNIVERSAL 236, 240					GR24X 70	1
GRILLO SPA						
MOTOCOLTIVATORI						
G107					53211	1
G131					E2X 45	1
RASAERBA						
BEE FLY					L1 50P	1
CLIMBER					E2X 45	1
DRAGON					GR24 70	1
FD 220					FT19-12B	1
KING, ROLLY					L0 44P	1
MOTOCARRIOLE						
DUMPER 507					L0 44P	1
TRANSPORTER						
24 M					GR24 70	1
25 M					GR24 70	1
131 TS					GR24 70	1
GUA						
AUTOGRU SG25					6DR7M	1
ESCAVATORE G800					6DR10P	1
ESCAVATORE SP20					L5 90P	1
GULDNER						
A2KN				AT 100 RSTd		1
A3KA				AT 100 RSTd		1
ABN				AT 100 RSTd		1

MARCHIO E MODELLO - MAKE AND MODEL MARQUE ET MODÈLE - MARKE UND MODELL MARCA Y MODELO - МАРКА И МОДЕЛЬ	powerCUBE		energyCUBE		Altre serie: Other series: TITANIUM CLASSICA MOTORENERGY	N° BTR
	APC	EHD	APC	RST		
GULDNER						
cont.						
ADN				AT 100 RSTd		1
HANOMAG						
14D	CX 225 APC	CX 200 EHD	CX 220 APC			1
18C	CX 225 APC	CX 200 EHD	CX 220 APC			1
B 8, B18C	A 135 APC	A 120 EHD / A 140 EHD				2
BRILLANT 600, 601, 700, 701	A 135 APC	A 120 EHD / A 140 EHD				1
GR8	A 135 APC	A 120 EHD / A 140 EHD				2
GRANIT 500				AT 100 RSTd		1
K 12C, 15, 16	CX 225 APC	CX 200 EHD	CX 220 APC			1
K 18C	A 135 APC	A 120 EHD / A 140 EHD				2
K 55, 70				AT 100 RSTd		1
KV 50				AT 100 RSTd		1
PERFECT 300, 400				AT 100 RSTd		1
R 27, 440	A 135 APC	A 120 EHD / A 140 EHD				1
ROBUSTUS 900.1	A 135 APC	A 120 EHD / A 140 EHD				1
HURLIMANN						
CLUB -478.4				G28 100 RST		1
H 345, 351, 352				G28 100 RST		1
H 356		MC12 120 EHD				1
H 358, 361, 362, 366, 372				G28 100 RST		1
H 360, 470				AT 100 RSTd		1
H 466		MC12 120 EHD				1
H 468/4 , 476 (XF), 478, 488				G28 100 RST		1
H 488 T					L5 100P	1
H 490		D14 148 EHD				1
H 496		MC12 120 EHD				1
H 496T		MC15 185 EHD / MC15 160 EHD				1
H 5100, 5110S				AT 100 RSTd		1
H 4105					L5 90P	1

MARCHIO E MODELLO - MAKE AND MODEL MARQUE ET MODÈLE - MARKE UND MODELL MARCA Y MODELO - МАРКА И МОДЕЛЬ	powerCUBE		energyCUBE		Altre serie: Other series: TITANIUM CLASSICA MOTORENERGY	N° BTR
	APC	EHD	APC	RST		
HURLIMANN <small>cont.</small>						
H 5110, 5116	A 135 APC	A 120 EHD / A 140 EHD				1
H 5116T		MC15 185 EHD / MC15 160 EHD				1
H 5200				AT 100 RSTd		1
H 6130, 6130, 6200				AT 100 RSTd		1
H 5650, 5660				G28 100 RST		1
H 6115, 6135, 6136		MC15 185 EHD / MC15 160 EHD				1
H 6165, 6170, 6190		MC15 185 EHD / MC15 160 EHD				1
H 6170T		MC15 185 EHD				1
H 6670, 6680, 6690		MC15 185 EHD				1
H 7600		MC12 120 EHD				1
H 7630		MC15 185 EHD / MC15 160 EHD				1
H 7650		MC15 185 EHD				1
H 7700				AT 100 RSTd		1
H 8610, 8613		MC15 185 EHD / MC15 160 EHD				1
H 9200				AT 100 RSTd		1
PRESTIGE H-478 B DT		MC12 120 EHD				1
Prince 35 (45) (55)					L3 70P	1
PRINCE 325, 325 XV, 335, 435, 435 HD, 445					L3 70P	1
SX 1200 DT, 1350 DT		MC15 185 EHD / MC15 160 EHD				1
SX 1500 DT, 1600 DT, 1800 DT, 2000 DT		MC15 185 EHD / MC15 160 EHD				1
XA 56, 66, 76, 86				G28 100 RST		1
XA 656 Dt				G28 100 RST		1
XA 657 (658) DT					L5 90P	1
XB Max 85 (100)				G28 100 RST		1
XB T/TB 75 (85) (95)				G28 100 RST		1
XE F Tradition 55 (70)				G28 100 RST		1
XE H-305 (306) (307) DT					L5 100P	1
XE H-355 (365) (375) F				G28 100 RST		1
XE Tradition 55 (70)				G28 100 RST		1
XF 70 (75) (90) (100)					L5 100P	1
XF H-361 DT				G28 100 RST		1
XF H-476 R DT				G28 100 RST		1
XF H-481 (491) DT				G28 100 RST		1
XL 150.7 (165.7) (185.7)	B 180 APC	B 180 EHD	B 185 APC			1
XM 100 (110) (130)		MC15 185 EHD / MC15 160 EHD				1
XN 706 (707) (708) (709) DT					L5 100P	1

MARCHIO E MODELLO - MAKE AND MODEL MARQUE ET MODÈLE - MARKE UND MODELL MARCA Y MODELO - МАРКА И МОДЕЛЬ	powerCUBE		energyCUBE		Altre serie: Other series: TITANIUM CLASSICA MOTORENERGY	N° BTR
	APC	EHD	APC	RST		
HURLIMANN						
cont.						
XS 70 (75) (90) (100)					L5 100P	1
XT 85, 95		MC12 120 EHD				1
XT 105, 115, 130		MC15 185 EHD / MC15 160 EHD				1
XT 110		MC12 120 EHD				1
XT 908 DT, 909 DT		MC12 120 EHD				1
XT 909, 910.6		MC15 185 EHD / MC15 160 EHD				1
XT 910.4 DT		MC12 120 EHD				1
XT 910.6 DT		MC15 185 EHD / MC15 160 EHD				1
XT 911 DT, 913 DT		MC15 185 EHD / MC15 160 EHD				1
INT. CASE						
533, 633, 733, 833					L5 90P	1
580, B, F, G				CHX 125 RST		1
584, 684, 784, 884				CHX 125 RST		1
844 XL, 845 XL		D11 135 EHD / D11 110 EHD				1
956 XL	A 135 APC	A 120 EHD / A 140 EHD				1
1394, 1494, 1594, 1694				CH 125 RST		1
1600, 1700, 1800 CV/D				CHX 125 RST		1
2300, 2400 SM, 2500 SM				CHX 125 RST		1
3400 SM, 3500 SM				CHX 125 RST		1
INT. HARVESTER						
323				G28 100 RST		1
323 V, 353 V					L5 90P	1
383				G28 100 RST		1
383 V					L5 90P	1
423				G28 100 RST		1
423 V					L5 90P	1
433					L5 90P	1
453				G28 100 RST		1
533					L5 90P	1
544		D11 135 EHD / D11 110 EHD				1

MARCHIO E MODELLO - MAKE AND MODEL MARQUE ET MODÈLE - MARKE UND MODELL MARCA Y MODELO - МАРКА И МОДЕЛЬ	powerCUBE		energyCUBE		Altre serie: Other series: TITANIUM CLASSICA MOTORENERGY	N° BTR
	APC	EHD	APC	RST		
INT. HARVESTER						
553, 623 V, 633					L5 90P	1
644, 654		D11 135 EHD / D11 110 EHD				1
724, 733, 734, 743					L5 90P	1
744		D11 135 EHD / D11 110 EHD				1
745 S, 824, 833					L5 90P	1
844, 856 XL		D11 135 EHD / D11 110 EHD				1
946, 956, 1046, 1055				G28 100 RST		1
1255, 1455 4WD				CH 125 RST		1
ISEKI						
1910, 3015, 3020, 3025, 3030					GR24X 70	1
2140, 2160, 3210					E2 45	1
3510				CB 110 RST		1
4270, 4320, 4370					GR24X 70	1
5000, 6000				CB 110 RST		1
TS3110				G28 100 RST		1
TX1300F, 1500F					E2 45	1
ITMA						
3.406					GR24X 70	1
3.65, 3.85				G28 100 RST		1
500 L, 600, 700 NL				G28 100 RST		1
A553NL				G28 100 RST		1
CINGOLATO A500, A503, 500 SNL				G28 100 RST		1
NIKE 350, L, LL, 401, L, LL				G28 100 RST		1
JCB						
110, 520, 702, 704				CH 125 RST		1
900, 902, 907, 1000, 1250, 1750				CH 125 RST		2
TELEAGRI PLUS				CB 110 RST		1
TELEFORCE 58				CB 110 RST		1
TIPO 2, 3				AT 100 RSTd		1
TIPO 5, C				CH 125 RST		1

MARCHIO E MODELLO - MAKE AND MODEL MARQUE ET MODÈLE - MARKE UND MODELL MARCA Y MODELO - МАРКА И МОДЕЛЬ	powerCUBE		energyCUBE		Altre serie: Other series: TITANIUM CLASSICA MOTORENERGY	N° BTR
	APC	EHD	APC	RST		
JOHN DEERE						
310, 510, 710					M4 132	2
650, 750					GR24X 70	1
930, 940, 1040					L1 44P	2
965, 975, 985	A 135 APC	A 120 EHD / A 140 EHD				1
1068H, 1177/ YESI					L5 90P	2
1116, 1118, 1130, 1140, 1177					L1 44P	2
1640, 1750, 2030, 2040, 2130, 2140					L1 44P	2
2155					L2 60P	2
2250, 2450, 2850					L1 44P	2
2355, 2355 N					L2 60P	2
2555, 2755, 2855, 2855 N					L2 60P	2
2955					L5 90P	2
3040, 3130, 3140, 3350, 3640, 3650					L5 90P	2
4055				G28 100 RST		2
4100, 4300					L2 60P	1
4240, 4350, 4450					L5 90P	2
4255, 4455, 4500, 4555				G28 100 RST		2
4650, 4850					L5 90P	2
4755, 4955, 4960				G28 100 RST		2
5200, 5300, 5400, 5500				G28 100 RST		1
5210, 5310, 5410, 5510				G28 100 RST		1
5215, 5315, 5415, 5515 (07-->)				G28 100 RST		1
5310, 5410, 5510 NARROW				G28 100 RST		1
5615 F				G28 100 RST		1
6000					L5 90P	2
6020 SE, 6120 SE, 6125				AT 100 RSTd		1
6110 C, 6210 C, 6310 C, 6410 C (4WD)	A 135 APC					1
6200				G28 100 RST		1
6220 SE, 6320 SE (Premium)				AT 100 RSTd		1
6320, 6420	A 135 APC					1
6420 S, SE (PLUS)				AT 100 RSTd		1
6505 R 4WD				AT 100 RSTd		1
6510 C 4WD	B 180 APC	B 180 EHD / B 160 EHD	B 185 APC			1
6515				AT 100 RSTd		1
6520	B 180 APC	B 180 EHD / B 160 EHD	B 185 APC			1
6520 SE (Premium)	A 135 APC					1
6530, 6630, 6830, 6930 (Premium) (07-->)	B 180 APC	B 180 EHD	B 185 APC			1
6610 C, 6810 C, 6910 C (4WD)	B 180 APC	B 180 EHD / B 160 EHD	B 185 APC			1
6620, 6620 SE, 6820 PLUS	A 135 APC					1
6910 S 4WD	B 180 APC	B 180 EHD / B 160 EHD	B 185 APC			1

MARCHIO E MODELLO - MAKE AND MODEL MARQUE ET MODÈLE - MARKE UND MODELL MARCA Y MODELO - МАРКА И МОДЕЛЬ	powerCUBE		energyCUBE		Altre serie: Other series: TITANIUM CLASSICA MOTORENERGY	N° BTR
	APC	EHD	APC	RST		
JOHN DEERE						
cont.						
6920 PLUS (Premium)	B 180 APC	B 180 EHD / B 160 EHD	B 185 APC			1
6920 S PLUS (S Premium)	B 180 APC	B 180 EHD / B 160 EHD	B 185 APC			1
7405, 7600, 7700, 7710				G28 100 RST		2
7430, 7530 Premium (07-->)	B 180 APC	B 180 EHD	B 185 APC			1
7800				CBX 110 RST		2
7810, 8100, 8200, 8300, 8400				G28 100 RST		2
7730, 7830, 7930, 8230, 8330, 8430, 8530 (07-->)				CBX 110 RST		2
8450					M5 160	2
8560, 8570, 8770				G28 100 RST		2
9300, 9400				G28 100 RST		2
KOMAT'SU						
BC 180 LC, 240 LC		D11 135 EHD / D11 110 EHD				2
BC 200 LC, 210 LC	A 135 APC	A 120 EHD / A 140 EHD				2
D 53, 85 A	CX 225 APC	CX 200 EHD	CX 220 APC			2
HA 205, 250	A 135 APC	A 120 EHD / A 140 EHD				2
HD 320	CX 225 APC	CX 200 EHD	CX 220 APC			2
MINI ESCAVATORI						
PC MISTRAL					E2X 45	1
PC12 R8, HS					E2X 45	1
PC15 R8, HS					E2X 45	1
PC20 R8					GR24X 70	1
PC27 R8					GR24X 70	1
PC30 MR					L2 64P	1
PC35 R8					GR24X 70	1
PC35 MR					L2 64P	1
PC45 R8					GR24X 70	1
PC50 MR					L3 80P	1
MIDI ESCAVATORI						
PC75 R-2		MC12 120 EHD				1
PW75 R-2		MC12 120 EHD				1
PC95 R-2		MC12 120 EHD				1
PW95 R-2		MC12 120 EHD				1
PC110 R-1		MC15 185 EHD / MC15 160 EHD				1
PW110 R-1		MC15 185 EHD / MC15 160 EHD				1

MARCHIO E MODELLO - MAKE AND MODEL MARQUE ET MODÈLE - MARKE UND MODELL MARCA Y MODELO - МАРКА И МОДЕЛЬ	powerCUBE		energyCUBE		Altre serie: Other series: TITANIUM CLASSICA MOTORENERGY	N° BTR
	APC	EHD	APC	RST		
KOMAT'SU						
cont.						
PALE COMPATTE						
SK04J-2					E2X 45	1
SK05J-2					GR24X 70	1
SK09J-2		MC12 120 EHD				1
SK510					L2 64P	1
SK714-5, 815-5, 818					L3 80P	1
TERNE						
WB70 A-1		MC12 120 EHD				1
WB98 A-2		MC15 185 EHD / MC15 160 EHD				1
WB91 R-2		MC15 185 EHD / MC15 160 EHD				1
WB93 R-2		MC15 185 EHD / MC15 160 EHD				1
WB97 R-2		MC15 185 EHD / MC15 160 EHD				1
WB97 S		MC15 185 EHD / MC15 160 EHD				1
MOVIMENTATORI TELESCOPICI						
WH609, 613		D11 135 EHD / D11 110 EHD				1
WH713, 714, 714H, 716		D11 135 EHD / D11 110 EHD				1
KRAMER						
KB 22, 180, 250, 400					GR24X 70	1
KUBOTA						
B 1410 D					B24 45	1
B 1550					E2 45	1
B 1610 D					B24 45	1
B 1750, 2150, 2550					E2 45	1
BX 2200 D					D23 60	1
G 18					B24 45	1
G 2160					B24 45	1
GZD 15, 16					B24J 45	1
L 175, 185, 225, 235, 245, 260, 275					GR24X 70	1
L 285, 295, 345, 355				CBX 110 RST		1
L 2500, 3110					GR24 70	1

MARCHIO E MODELLO - <i>MAKE AND MODEL</i> MARQUE ET MODÈLE - <i>MARKE UND MODELL</i> MARCA Y MODELO - <i>МАРКА И МОДЕЛЬ</i>	powerCUBE		energyCUBE		Altre serie: <i>Other series:</i> TITANIUM CLASSICA MOTORENERGY	N° BTR
	APC	EHD	APC	RST		
KUBOTA						
cont.						
L 3010, 3710, 4310					GR24X 70	1
M 4000, 4050, 4500				G28X RST		1
M 4700, 5400, 6800, 8030, 8200,9000				G28 100 RST		1
TG 1860					B24 45	1
ESCAVATORI						
KX 91-3					L3X 74P	1
KX 101-3					L3X 74P	1
U 20/25-3					L1X 44	1
U 35					L3X 74P	1
LALTESI						
ESCAVATORE 111		MC15 185 EHD / MC15 160 EHD				1
ESCAVATORE 221, 222G				G28 100 RST		2
ESCAVATORE 341, 441HD, 541, 541 S		MC15 185 EHD / MC15 160 EHD				2
LAMBORGHINI						
4R					L5 90P	1
7R, DT				AT 100 RSTd		1
105				G28 100 RST		1
115, 135, 165		MC15 185 EHD / MC15 160 EHD				1
1506T		MC15 185 EHD				1
340				G28 100 RST		1
470, 480					6DR7M	1
564.60				G28 100 RST		1
574.70 N, 574.N					L5 90P	1
600, 660 F, 660 V				G28 100 RST		1
674, 674.70, 674.70 N, 674.80 N					L5 90P	1
700				G28 100 RST		1
704		MC15 185 EHD / MC15 160 EHD				1
775 F, V				G28 100 RST		1
804, 850		MC15 185 EHD / MC15 160 EHD				1
950, 1050, 1060, 1106, 1306		MC15 185 EHD / MC15 160 EHD				1
AGILE 660 (770) (880) (990) S					L5 100P	1

MARCHIO E MODELLO - MAKE AND MODEL MARQUE ET MODÈLE - MARKE UND MODELL MARCA Y MODELO - МАРКА И МОДЕЛЬ	powerCUBE		energyCUBE		Altre serie: Other series: TITANIUM CLASSICA MOTORENERGY	N° BTR
	APC	EHD	APC	RST		
LAMBORGHINI <small>cont.</small>						
C 352					L3 70P	1
C 353 L, 362 S, 453 N, 503 S, 553 L, 553 S, 554				G28 100 RST		1
C 603 L, 653 L, 684 L, 754 L, 784 L				G28 100 RST		1
C 664				G28 100 RST		1
C 674-40, 674-70, C 774-80 (Erg.), C874-90 (Erg)				G28 100 RST		1
CF 90 (100)				G28 100 RST		1
CV 70 (80)				G28 100 RST		1
CHAMPION 120 DT, 135 DT, 150 DT		MC15 185 EHD / MC15 160 EHD				1
CHAMPION 160, 180 (DT) (I.CAB)		MC15 185 EHD / MC15 160 EHD				1
CHAMPION 200 I.CAB		MC15 185 EHD / MC15 160 EHD				1
CRONO 55 F, 65 F, 75 F				G28 100 RST		1
CRONO Target 2.56 (2.58) (2.66) (2.76) (2.86)				G28 100 RST		1
CRONO Target 55 (60)				G28 100 RST		1
CRONO Target F 55 (F 60)				G28 100 RST		1
CROSS 674 70 N				G28 100 RST		1
CROSS 774 80 N				G28 100 RST		1
DL30, CTL, SUPER					L5 90P	1
GRAND PRIX 674-70 (774-80) (874-90) LS					L5 90P	1
GRIMPER 555, 560, 560 G, 570				G28 100 RST		1
PLUS 660 F, 775 F REV, 880 F, 990 F				G28 100 RST		1
PREMIUM 850, 950, 1050, 1060		MC12 120 EHD				1
PREMIUM 1100, 1300		MC15 185 EHD / MC15 160 EHD				1
R 1.35 (R 1.45) (R 1.55)					L3 70P	1
R3 Evo 85 (100)					L5 100P	1
R3 T 75 (85) (95)				G28 100 RST		1
R3 TB 75 (85) (95)				G28 100 RST		1
R 4.85 (4.95)		MC12 120 EHD				1
R 4.105 (4.110) (4.120)		MC15 185 EHD / MC15 160 EHD				1
R 5.115 (5.130)		MC15 185 EHD / MC15 160 EHD				1
R 6.100		MC12 120 EHD				1
R 6.110		MC15 185 EHD / MC15 160 EHD				1
R 6.VRT 150.7 (160.7)	B 180 APC	B 180 EHD	B 185 APC			1
R 7.175 S (7.190 S)		MC15 185 EHD / MC15 160 EHD				1
R 7.200 --> '06		MC15 185 EHD / MC15 160 EHD				1
R 7.200 '07-->	B 180 APC	B 180 EHD	B 185 APC			1
R 8.230 (8.270)	B 180 APC	B 180 EHD	B 185 APC			1

MARCHIO E MODELLO - MAKE AND MODEL MARQUE ET MODÈLE - MARKE UND MODELL MARCA Y MODELO - МАРКА И МОДЕЛЬ	powerCUBE		energyCUBE		Altre serie: Other series: TITANIUM CLASSICA MOTORENERGY	N° BTR
	APC	EHD	APC	RST		
LAMBORGHINI						
<i>cont.</i>						
R F 75 (90) (100)					L5 100P	1
R S 75 (90) (100)					L5 100P	1
R 235					L3 70P	1
R 355 DT, 365 DT, 475 DT				AT 100 RSTd		1
R 483 DT, 503, 503 DT				G28 100 RST		1
R 564 DT, 603 DF				G28 100 RST		1
R 653 DT, DTF, F				G28 100 RST		1
R 684 DT, DTF, F				G28 100 RST		1
R 754 DT, 784 DT, 804 DTS				G28 100 RST		1
R 850, 904 DT, 904 DTS		MC12 120 EHD				1
R 950, 955 DT, 956, 1050		MC12 120 EHD				1
R 1056 DT		MC15 185 EHD / MC15 160 EHD				1
R 1060		MC12 120 EHD				1
R 1156 DT, 1256 DT, 1356 DT		MC15 185 EHD / MC15 160 EHD				1
RACING 150, 165, 190, HI.PER.		MC15 185 EHD				1
RUNNER 250 (JET), 350 (HD) (A), 450					L3 70P	1
SPRINT 664-65				G28 100 RST		1
TRIUMPH 80, 90, 100		MC12 120 EHD				1
LANDINI						
50, 55, 60, 65, 75, 85, 95					L5 90P	1
65.30					GR24X 70	1
68.30 , 68.40				G28 100 RST		1
85.30 , 85.50, 88.30				G28 100 RST		1
4500					L5 90P	1
5000, 5005, 5030, 5500, 5560				G28 100 RST		1
5860, 6000				G28 100 RST		1
6030, 6040					GR24X 70	1
6060, 6070, 6500, 6505, 6560, 6830				G28 100 RST		1
6880					L5 90P	1
7000, 7500, 7505, 7530				G28 100 RST		1
7550					L5 90P	1
7830, 7860				G28 100 RST		1
7880	B 180 APC	B 180 EHD / B 160 EHD	B 185 APC			1
8000, 8550				G28 100 RST		1
8500					L5 90P	1
8830, 8860				G28 100 RST		1
8880, 9080	B 180 APC	B 180 EHD / B 160 EHD	B 185 APC			1

MARCHIO E MODELLO - MAKE AND MODEL MARQUE ET MODÈLE - MARKE UND MODELL MARCA Y MODELO - МАРКА И МОДЕЛЬ	powerCUBE		energyCUBE		Altre serie: Other series: TITANIUM CLASSICA MOTORENERGY	N° BTR
	APC	EHD	APC	RST		
LANDINI <small>cont.</small>						
9500					L5 90P	1
9880	B 180 APC	B 180 EHD / B 160 EHD	B 185 APC			1
10.000, 13.000MKII, 14.500MKII				CH 125 RST		1
10000		MC15 185 EHD / MC15 160 EHD				1
10500					L5 90P	1
12500		MT 132 EHD				1
13000, 13500		MC15 185 EHD / MC15 160 EHD				1
14500		MT 132 EHD				1
16500/4RM				CH 125 RST		1
ALPINE 60 (70) (80) (GT)				G28 100 RST		1
ALPINE 65 (75) (85) STD, GT				G28 100 RST		1
ATLANTIS DT 70, 80, 90, 100				G28 100 RST		1
ATLAS DT 70, 80, 90, 100				G28 100 RST		1
C 25 DIESEL					L5 90P	1
C 4500, 5000, 6500				G28 100 RST		1
CL 3200				G28 100 RST		1
DISCOVERY 65 (85) C, M				G28 100 RST		1
DT 5000				G28 100 RST		1
DT 9500		MC12 120 EHD				1
GHIBLI DT 80, 90, 100				G28 100 RST		1
GLOBUS 55 (60) (65) (70) (75) (80)				G28 100 RST		1
L 25					L5 90P	1
L 35, 44 MAJOR, 45, 55 B				AT 100 RSTd		1
LANDPOWER 125 (135) (145) (165) (180) (185)		MC12 120 EHD				1
LEGEND 105, 115, 130, 145, 165, 180		MT 132 EHD				1
LEGEND 120 (140) (160)		MC12 120 EHD				1
MISTRAL 40, 45, 50, 55					L2 60P	1
MYTHOS DT 90, 100				G28 100 RST		1
MYTHOS DT 110		MT 132 EHD				1
POWERFARM 60 (75) (80) (85) (90) (95) (100) (105)				G28 100 RST		1
R 25					L5 90P	1
R 4500, 5000 N, 5000 S				G28 100 RST		1
R 7000 DT, 8000, 8500, 9500		MC12 120 EHD				1
REX 60, 70, 80, 90, 100 (F) (GE)				G28 100 RST		1
REX 75, 85, 95, 105 (GT)				G28 100 RST		1
REX 1000 GT				G28 100 RST		1
REX F (GE) 65, 75, 85, 95, 105				G28 100 RST		1
REX V 60, 65, 70, 80					L3 70P	1
RV 25					L5 90P	1
TREKKER series				G28 100 RST		1
VISION DT 80 (90) (100) TOP				G28 100 RST		1
VISION 85 (95) Techno				G28 100 RST		2

MARCHIO E MODELLO - MAKE AND MODEL MARQUE ET MODÈLE - MARKE UND MODELL MARCA Y MODELO - МАРКА И МОДЕЛЬ	powerCUBE		energyCUBE		Altre serie: Other series: TITANIUM CLASSICA MOTORENERGY	N° BTR
	APC	EHD	APC	RST		
LAVERDA						
150		MC15 185 EHD / MC15 160 EHD				1
3300 AL		MC12 120 EHD				1
3350 AL		MC15 185 EHD / MC15 160 EHD				1
3400		MC15 185 EHD				1
3450		MC15 185 EHD / MC15 160 EHD				1
3550		MC15 185 EHD				1
3600, 3700, 3750, 3790, 3890, 3900		MC15 185 EHD / MC15 160 EHD				1
AFC 16					GR24X 70	1
M 92 AL		MC12 120 EHD				1
M 112, 120, 132		MT 132 EHD				1
M 152, M, OM, TA		MC15 185 EHD / MC15 160 EHD				1
M 152 MP		MT 132 EHD				1
LINDNER						
GEOTRAC 50					L5 90P	1
GEOTRAC 65					L5 90P	1
GEOTRAC 73, 83	A 135 APC					1
GEOTRAC 93, 103	A 135 APC					1
LOMBARDINI						
TL 25				AT 100 RSTd		1
TL 30, 40					L5 90P	1
MANITOU						
202 B, 252 B, 302 B	B 180 APC	B 180 EHD / B 160 EHD	B 185 APC			1
2050 DF 33					L5 90P	1
244H, 344H				CB 110 RST		1
2550 DP 33		D11 135 EHD / D11 110 EHD				1
4 RE 20C, 20CL, 25C, 25CL				CB 110 RST		1

MARCHIO E MODELLO - MAKE AND MODEL MARQUE ET MODÈLE - MARKE UND MODELL MARCA Y MODELO - МАРКА И МОДЕЛЬ	powerCUBE		energyCUBE		Altre serie: Other series: TITANIUM CLASSICA MOTORENERGY	N° BTR
	APC	EHD	APC	RST		
MANITOU						
cont.						
4 RE 30H	B 180 APC	B 180 EHD / B 160 EHD	B 185 APC			1
4 RM 20 C (FA) (G) (H) (P)				CB 110 RST		1
4 RM 25 C (FA) (G)				CB 110 RST		1
4 RM 26 (N)				CB 110 RST		1
4 RM 35C, 40C	B 180 APC	B 180 EHD / B 160 EHD	B 185 APC			1
BL 22				CHX 125 RST		1
CHOULEUR 62		D11 135 EHD / D11 110 EHD				1
HC 20 E, 25 E					L5 90P	1
IF 25.25 F, 25.30 F				CB 110 RST		1
MA 20, 25 vari modelli				CB 110 RST		1
MB 16 S, 20, 21, 25, 26, 30 vari modelli				CB 110 RST		1
MB 25 P				CHX 125 RST		1
MB 25 D, 25 TC, 30 TC, 40, 50, 60	B 180 APC	B 180 EHD / B 160 EHD	B 185 APC			1
MC 10, 15, 18, 20, 25, 30 vari modelli				CB 110 RST		1
MC 40 TC, 50, 80	B 180 APC	B 180 EHD / B 160 EHD	B 185 APC			1
MCE 20, 25, 30 vari modelli				CB 110 RST		1
MCL 30H				CB 110 RST		1
MASSEY FERGUSON						
148, 187, 520, 625, 670, 760				CB 110 RST		1
244 CRAWLER				CH 125 RST		1
3315-4, 3325-4, 3330-4, 3340-4, 3350-4, 3355-4					L5 100P	1
4225-4, 4235-4				CB 110 RST		2
4245-4, 4255-4				CB 110 RST		2
4270-4					L3 70P	2
6245-4, 6255-4, 6260-4, 6265-4					L3 70P	2
6270-4, 6280-4, 6290-4					L3 70P	2
8210-4, 8220-4, 8240-4, 8250-4					L3 70P	2
8270-4, 8280-4				CB 110 RST		2
FE 1L, 35, 175				CH 125 RST		1
FE 65 3CYL, 4L				CB 110 RST		1
FE135					L3X 74P	1
FE 135 COLD				CH 125 RST		1
MF 11, 16, 20, 27, 29, 30, 31, 35, 40, 50		D11 135 EHD / D11 110 EHD				1
MF 24, 27, 29, 31 ('85->)		D11 135 EHD / D11 110 EHD				1

MARCHIO E MODELLO - MAKE AND MODEL MARQUE ET MODÈLE - MARKE UND MODELL MARCA Y MODELO - МАРКА И МОДЕЛЬ	powerCUBE		energyCUBE		Altre serie: Other series: TITANIUM CLASSICA MOTORENERGY	N° BTR
	APC	EHD	APC	RST		
MASSEY FERGUSON <small>cont.</small>						
MF 133, 134C, 154C				CH 125 RST		1
MF134V, 154S,154V, 164V					GR24X 70	1
MF 134V, 154V, 164V, 174V 184S (11/88-->)					L3 70P	1
MF174S, 184S, 194F (11/88 -->)				G28 100 RST		1
MF174V, 184S, 194A, 194F (11/88 -->)				CH 125 RST		1
MF154					L3X 74P	1
MF 145C, 165C, 174C				CH 125 RST		1
MF 135, 148, 152, 155, 158, 165, 168				CB 110 RST		1
MF 175, 178, 185, 188, 252,				CB 110 RST		1
MF 230, 240, 250 (->'85)				CB 110 RST		1
MF 230, 240, 250 ('85 -->)					L3X 74P	1
MF 234C, 254C, 274C, 294C, 298, 362				CH 125 RST		1
MF 234S, 254					GR24X 70	1
MF 254S					L5 90P	1
MF 252				CB 110 RST		1
MF 253, 275					L3X 74P	1
MF 263, 265, 274S, 274SK, 290				CB 110 RST		1
MF 274S, 274SK, 284S, 294S				G28 100 RST		1
MF 340, 350, 355, 360					L3X 74P	1
MF 353, 363					GR24X 70	1
MF 353, 363 (--> 11/88)					L5 90P	1
MF 354S, 354F, 364F					L5 90P	1
MF 365, 375, 390T, 398, 399					L3X 74P	2
MF 373, 374S, 383, 384S, 393 (11/88 -->)				G28 100 RST		1
MF 394S				G28 100 RST		1
MF 383, 393				CH 125 RST		1
MF 410, 418, 487, 500, 507, 510				CB 110 RST		1
MF 515, 520, 525, 620, 625, 630				CB 110 RST		1
MF 550, 565, 575, 590, 670				CB 110 RST		1
MF 595				MC 130 RST		1
MF 655, 665				CH 125 RST		1
MF 675, 690, 698 (->'85)				CH 125 RST		1
MF 675, 690, 698 ('85 -->)					L3X 74P	2
MF 699					L3X 74P	2
MF 750, 760					L3X 74P	1
MF 828, 830, 835, 845				CH 125 RST		1
MF 850,860					L3X 74P	1
MF 1020, 1030, 1040, 1080				CB 110 RST		1
MF 1100, 1105, 1135, 1155, 1550				CH 125 RST		1
MF 1505, 2135, 2203, 2205				CB 110 RST		1
MF 2135C, 2203C				CH 125 RST		1
MF 2210, 2225, 2235				G28 100 RST		1
MF 2430, 2435, 2440				G28 100 RST		1
MF 2620				CB 110 RST		2
MF 2625					L3X 74P	2

MARCHIO E MODELLO - MAKE AND MODEL MARQUE ET MODÈLE - MARKE UND MODELL MARCA Y MODELO - МАРКА И МОДЕЛЬ	powerCUBE		energyCUBE		Altre serie: Other series: TITANIUM CLASSICA MOTORENERGY	N° BTR
	APC	EHD	APC	RST		
MASSEY FERGUSON						
cont.						
MF 2645, 2685, 2725 (->31/08/'85)		D11 135 EHD / D11 110 EHD				2
MF 2645, 2685, 2725 8 (10/85 -->)					L3X 74P	2
MF 2680, 2720				CB 110 RST		2
MF 3050, 3060, 3065, 3070, 3080, 3090, 3095					L3X 74P	2
MF 3115, 3120, 3125					L3X 74P	2
MF 3315 F, 3325 F, 3330F, 3340F, 3350F, 3355F					L5 100P	1
MF 3425, 3435, 3445, 3455					L5 100P	1
MF 3610, 3630, 3635, 3645, 3650, 3655					L3X 74P	2
MF3670, 3680, 3690					L3X 74P	2
MF 4200, 4215, 4225, 4230,				CB 110 RST		1
MF 4233, 4235, 4240, 4243, 4245, 4255				CB 110 RST		1
MF 4435, 4445, 4455				CB 110 RST		1
MF 5425, 5435, 5445, 5455, 5460, 5465, 5470, 5475					L5 100P	1
MF 6445, 6455, 6460, 6470					L3X 74P	2
MF 6465, 6475, 6480 DYNASHIFT PLUS					L3X 74P	2
MF 6485, 6490, 6495 DYNASHIFT PLUS					L3X 74P	2
MF 6497, 6499					L3X 74P	2
MF 7250, 7252, 7254, 7256, 7272, 7274, 7276		D11 135 EHD / D11 110 EHD				1
MF 7465, 7475, 7480 DYNA-VT					L3X 74P	2
MF 7485, 7490, 7495 DYNA-VT					L3X 74P	2
MF 8140, 8150, 8160, 8170				CB 110 RST		2
MF 8210, 8220, 8230, 8240, 8250					L3X 74P	2
MF 8240, 8250, 8260, 8270, 8280				CB 110 RST		1
TA PERKINS					GR24X 70	1
TE series					GR24X 70	1
TEF (P3)					GR24X 70	1
TEF 20, 745 S, TE 20, TF-F					M4 132	2
MC CORMICK						
C 50 (60) (70) (80)				G28 100 RST		1
C-MAX 60 (75) (85) (95) (105)				G28 100 RST		1
CX 70, 80, 90, 100				G28 100 RST		1
CX 75 (85) (95) (105) XTRA SHIFT				G28 100 RST		1
CX 75 (85) (95) (105) XTRA SHIFT ('07-->)				CBX 110 RST		1
F 60-4, 70-4, 80-4, 90-4, 100-4				G28 100 RST		1
F 75 (85) (95) (105) (GE) (XL)				G28 100 RST		1
GM 40, 45, 50, 55					L2 60P	1
GX 40, 45, 50					D23X 60	1
MC 80, 90, 100				G28 100 RST		1
MTX 110, 125, 140, 155		MT 132 EHD				1

MARCHIO E MODELLO - MAKE AND MODEL MARQUE ET MODÈLE - MARKE UND MODELL MARCA Y MODELO - МАРКА И МОДЕЛЬ	powerCUBE		energyCUBE		Altre serie: Other series: TITANIUM CLASSICA MOTORENERGY	N° BTR
	APC	EHD	APC	RST		
MC CORMICK						
cont.						
T 70, 80, 90, 100 (F) (FL)		MT 132 EHD				1
V 65-4					L3 70P	1
XTX 150 (165) (185)				CB 110 RST		1
ZTX 230 (260) (280)				G28 100 RST		2
MERLO						
AUTOBETONIERA 2000, 2500, 3000		MC15 185 EHD / MC15 160 EHD				1
AUTOBETONIERA DBM1200					L5 90P	1
NAPOLIONE						
TRATTORI e MOTOCOLTIVATORI				G28 100 RST		1
NEW HOLLAND						
35-66 DT					L2 60P	1
60-66 S (60-66 SDT)		MT 132 EHD				1
65-66 SDT (70-66 S) (70-66 SDT)		MT 132 EHD				1
70				CB 110 RST		2
77, 80, 89, 102, 133, 135, 140					M5 160	2
80-66 S DT		MT 132 EHD				1
82-86 LP DT		MT 132 EHD				1
110-90 DT		MT 132 EHD				1
818, 903, 907					GR24 70	2
1500 F, 1520 F, 1530 F, 1540 F, 1545 F				G28 100 RST		2
1520, 1530, 1540					M4 132	2
1550, 1770					L3 70P	2
1580 AL					L5 90P	2
1800				CB 110 RST		2
1880, 1890, 1895					GR24 70	2
1900				G28 100 RST		2
8030, 8040					L5 90P	1
8050, 8060, 8060 I					L3 70P	2
8055		D11 135 EHD / D11 110 EHD				1
8070, 8070 I, 8080, 8080 I					L5 90P	2
8360, 8670, 8970				G28 100 RST		1

MARCHIO E MODELLO - MAKE AND MODEL MARQUE ET MODÈLE - MARKE UND MODELL MARCA Y MODELO - МАРКА И МОДЕЛЬ	powerCUBE		energyCUBE		Altre serie: Other series: TITANIUM CLASSICA MOTORENERGY	N° BTR
	APC	EHD	APC	RST		
NEW HOLLAND						
cont.						
FX 58, 375					L5 90P	2
G 190	A 135 APC	A 120 EHD / A 140 EHD				1
L 518, 627		MC15 185 EHD / MC15 160 EHD				1
LM 430				AT 100 RSTd		1
M 160	A 135 APC	A 120 EHD / A 140 EHD				1
T 3010 (3020) (3030) (3040) '07-->					L2 60P	1
T 4020 (4030) (4040) (4050) '08-->				G28 100 RST		1
T 4030 F (4040 F) (4050 F) '08-->				G28 100 RST		1
T4.55 / T4.65 / T4.75					L5 100P	1
T 5030 (5040) (5050) '08-->		MT 132 EHD				1
T5.95 / T5.105 / T5.115		MT 132 EHD				1
T 6010 (6020) (6030) (6040) (6050) (6060) (6070) (6080) '08-->		MT 132 EHD				1
T6.120 / T6.140 / T6.150 / T6.155 / T6.160 / T6.165 / T6.175	A 135 APC	A 140 EHD				1
T 7030 (7040) (7050) (7060) '08-->	B 180 APC	B 180 EHD	B 185 APC			1
T 7520 (7530) (7540) (7550) '08-->		MC15 185 EHD				1
T7.170 / T7.185 / T7.200 / T7.210 / T7.220 / T7.235 / T7.240 / T7.250 / T7.260 / T7.700 / T7.710	B 180 APC	B 180 EHD	B 185 APC			1
TCE 40 (45) (50) (55) --> '06					L2 60P	1
TD 4020F / TD 4030F / TD 4040F					L5 100P	1
TDD 75 (85) (95) DT				CB 110 RST		1
TK-TKF-TKFA-TKM-TKMA-TKV serie					L5 100P	1
TK4000-TK4000M-TK4000V serie					L5 100P	1
TL 70, 80, 90, 100 (DT)		MT 132 EHD				1
TL-A 70 (80) (90) (100)		MT 132 EHD				1
TM 115, 125, 135, 150, 165 (DT)					L5 90P	1
TM 120 (130) (140) (155) (175) (190)	B 180 APC	B 180 EHD	B 185 APC			1
TM 155 (175) (190)	B 180 APC	B 180 EHD	B 185 APC			1
TN 55, 65, 70, 75,					D31 95	1
TN 60A, TN 70A, TN 75A, TN85A, TN 95A (D)					D31 95	1
TNFA serie					L5 100P	1
TNN serie					L5 100P	1
TNNA serie					D31 95	1
TNS serie					L5 100P	1
TNV-TNVA serie					D31 95	1
TR 85	A 135 APC	A 120 EHD / A 140 EHD				1
TS-TSA-TSA Delta serie				CB 110 RST		
TVT serie	B 180 APC	B 180 EHD	B 185 APC			
TV 140				CH 125 RST		2
TX 30, 32, 34					L2 64P	2
TX 36					L3 70P	
TX 62, 63,64, 65, 66, 67, 68, 68					L5 90P	2

MARCHIO E MODELLO - MAKE AND MODEL MARQUE ET MODÈLE - MARKE UND MODELL MARCA Y MODELO - МАРКА И МОДЕЛЬ	powerCUBE		energyCUBE		Altre serie: Other series: TITANIUM CLASSICA MOTORENERGY	N° BTR
	APC	EHD	APC	RST		
NIBBI						
G 219 S, 319 S					L1X 44	1
G 419 S, 819, 824					L1X 44	1
MOTOFALCIATRICI					53211	1
OM						
35 R, 40 R, 45 R.C, 50 R.C					L5 90P	1
512 R, 513 SUPER				G28 100 RST		2
605		MC15 185 EHD / MC15 160 EHD				1
650, DT, SPECIAL		MC12 120 EHD				1
655 C, 715		MC15 185 EHD / MC15 160 EHD				1
750 SPECIAL, 780, 850, 850 DT		MC15 185 EHD / MC15 160 EHD				1
750, DT		MC12 120 EHD				1
880, 1000, 1000 FT		MC15 185 EHD / MC15 160 EHD				1
ORSI						
ARGO				AT 100 RSTd		1
CD 30					L5 90P	1
CDA 363, 404, 454					L5 90P	1
ARGO				AT 100 RSTd		1
CD 30					L5 90P	1
CDA 363, 404, 454					L5 90P	1
PASQUALI						
116, 403					53211	1
406					E2X 45	1
439, 440				G28 100 RST		1
446, 451					L2 60P	1
453, 455				G28 100 RST		1
456					L2 60P	1
457				G28 100 RST		1
461					F60-N24AL-B	1
464, 467, 470, 485				G28 100 RST		1

MARCHIO E MODELLO - MAKE AND MODEL MARQUE ET MODÈLE - MARKE UND MODELL MARCA Y MODELO - МАРКА И МОДЕЛЬ	powerCUBE		energyCUBE		Altre serie: Other series: TITANIUM CLASSICA MOTORENERGY	N° BTR
	APC	EHD	APC	RST		
PASQUALI						
cont.						
487, 488					L2 60P	1
492, 494, 497				G28 100 RST		1
917.20, 917.21					E2X 45	1
934.20, 934.27					F60-N24AL-B	1
941, 944, 945, 946					L2 60P	1
947, 951				G28 100 RST		1
955, 956					L2 60P	1
957				G28 100 RST		1
959					L2 60P	1
963					53211	1
965, 970				G28 100 RST		1
971					L2 60P	1
976, 978, 979				G28 100 RST		1
985, 986					L2 60P	1
987				G28 100 RST		1
988, 990					L2 60P	1
991				G28 100 RST		1
992, 993, 995					L2 60P	1
996, 997				G28 100 RST		1
CRONOS 7.65				G28 100 RST		1
CRONOS 7.85				G28 100 RST		1
EOS 5,50 AR Mono					GR24X 70	1
EOS 6,50					L3 70P	1
ERA 9.30 (9.40) DT					E2 45	1
ERGO 5.60, 5.80 (Mono)				G28 100 RST		1
ERGO 6.60, 6.80 (Mono)				G28 100 RST		1
ERGO 8.80 S2 REV (Hm)				G28 100 RST		1
MARS 7.70 (7.80) (7.90) AR Mono				G28 100 RST		1
MARS 8.70 (8.80) (8.90) RS Mono				G28 100 RST		1
MOTOAGRICOLE 95640, 95641					L1 44P	1
MOTOCOLTIVATORE 941, 946					L1 44P	1
TRATTORE 956, 991				G28 100 RST		1
TRATTORINI 945, 955, 985, 990, 992, 995					L1 44P	1
VANTH 5.30, 6.30 (Mono)					E2 45	1
VANTH 5.40, 6.40 (Mono)					E2 45	1
PERLINI						
121.27, 131.33		MC15 185 EHD / MC15 160 EHD				2
DUMPERS 203, 205, 218, 225		MC15 185 EHD / MC15 160 EHD				2
DUMPERS 341, 361, 363, 366, 366 C		MC15 185 EHD				4

MARCHIO E MODELLO - MAKE AND MODEL MARQUE ET MODÈLE - MARKE UND MODELL MARCA Y MODELO - МАРКА И МОДЕЛЬ	powerCUBE		energyCUBE		Altre serie: Other series: TITANIUM CLASSICA MOTORENERGY	N° BTR
	APC	EHD	APC	RST		
PERLINI						
cont.						
DUMPERS 655, 655 C, 755		MC15 185 EHD				4
DUMPERS T35, T40					6DR10P	2
VEICOLI SPECIALI 605D ('91->)	B 180 APC	B 180 EHD	B 185 APC			1
VEICOLI SPECIALI 605D (->'90)		MC15 185 EHD				1
VEICOLI SPECIALI B505 ('91->)	B 180 APC	B 180 EHD	B 185 APC			1
VEICOLI SPECIALI B505 (->'90)		MC15 185 EHD				1
PGS						
PGS 5000					M4 132	2
ROMA 21, 23, 30, 36, 38, 42, 45					L1 44P	1
ROMA 50, 55, 60					L1 44P	1
ROMA 60 RS, 80 RS				G28 100 RST		1
TRATTORINO					L1 44P	1
POCLAIN						
Escavatori 60, 90, 115, 160		B 180 EHD (B03)				2
GC, GY		D11 135 EHD / D11 110 EHD				2
GCI 20				AT 100 RSTd		2
GCK	A 135 APC	A 120 EHD / A 140 EHD				2
LC, LY		D11 135 EHD / D11 110 EHD				2
MC	B 180 APC	B 180 EHD / B 160 EHD	B 185 APC			2
MY	A 135 APC	A 120 EHD / A 140 EHD				2
P 10, 20	A 135 APC	A 120 EHD / A 140 EHD				2
SC	B 180 APC	B 180 EHD / B 160 EHD	B 185 APC			2
RENAULT Agricoltura						
32.50 SV, 34.60 V					L5 90P	1
R 55 (56) (61) (67) (68)					M4 132	2
58.12 (58.14) LS				CB 110 RST		1

MARCHIO E MODELLO - MAKE AND MODEL MARQUE ET MODÈLE - MARKE UND MODELL MARCA Y MODELO - МАРКА И МОДЕЛЬ	powerCUBE		energyCUBE		Altre serie: Other series: TITANIUM CLASSICA MOTORENERGY	N° BTR
	APC	EHD	APC	RST		
RENAULT Agriculture cont.						
65.12 (65.14) LS				CB 110 RST		1
80.12, 80.14F					L5 90P	1
R 86 (88) (89) (90)					M4 132	2
R 91 (92) (94) (96)					M4 132	2
106.54, 110.14, 110.54	B 180 APC	B 180 EHD / B 160 EHD	B 185 APC			1
113.12, 113.14, 133.12					M4 132	2
120.14, 120.54, 133.14					M4 132	2
133.54	B 180 APC	B 180 EHD / B 160 EHD	B 185 APC			1
145.14, 145.54, 155.54	B 180 APC	B 180 EHD / B 160 EHD	B 185 APC			1
160.94, 175.74	B 180 APC	B 180 EHD / B 160 EHD	B 185 APC			1
R 456					M4 132	2
R 460, 461, 462, 480 , 482 S					L5 90P	1
R 486, 489					M4 132	2
R 496, 498, 891, 951, 981					M4 132	2
ARES 500				CB 110 RST		1
ARES 540 (550) RX	B 180 APC	B 180 EHD	B 185 APC			1
ARES 546 (556) (566) RX, RZ	B 180 APC	B 180 EHD	B 185 APC			1
ARES 610 (620) (630) RX, RZ	B 180 APC	B 180 EHD	B 185 APC			1
ARES 616 (626) RX, RZ	B 180 APC	B 180 EHD	B 185 APC			1
ARES 636 (640) RZ	B 180 APC	B 180 EHD	B 185 APC			1
ARES 656 (696) RZ	B 180 APC	B 180 EHD	B 185 APC			1
ARES 710 (720) RZ	B 180 APC	B 180 EHD	B 185 APC			1
ARES 816 (826) (836)	B 180 APC	B 180 EHD	B 185 APC			1
ATLES 926 (936) RZ	B 180 APC	B 180 EHD	B 185 APC			1
CERES 320 (330)				CB 110 RST		1
CERES 325 (335) (345) (355)				CB 110 RST		1
CERES 325 (335) X				CB 110 RST		1
CERES 340 X				CB 110 RST		1
CERES 345 (355) X				CB 110 RST		1
CERGOS 335 (345)				CB 110 RST		1
CERGOS 340 (350)				CB 110 RST		1
CERGOS 355				CB 110 RST		1
DIONIS 110 (120) (130) (140)				G28 100 RST		1
ERGOS 85 (95) (105)				CB 110 RST		1
FRUCTUS 120 (130) (140)				G28 100 RST		1
PALES 210 (230) (240)				G28 100 RST		1
R 851-4, 951-4, 1151-4					M4 132	2
R 7050, 7051, 7052 5D, 7052 6D					M4 132	2
R 7053 SUPER					M4 132	2
TEMIS 550 X				CB 110 RST		1
TEMIS 560				CB 110 RST		1

MARCHIO E MODELLO - MAKE AND MODEL MARQUE ET MODÈLE - MARKE UND MODELL MARCA Y MODELO - МАРКА И МОДЕЛЬ	powerCUBE		energyCUBE		Altre serie: Other series: TITANIUM CLASSICA MOTORENERGY	N° BTR
	APC	EHD	APC	RST		
PERLINI						
cont.						
TEMIS 610 (630) (650) X	B 180 APC	B 180 EHD	B 185 APC			1
RUGGERINI						
R 25					L1 44P	1
RD 15, 22					L1X 44	1
SAME						
105 T FORMULA					L5 90P	1
120 VIGNETO				AT 100 RSTd		1
240, 250					M4 132	2
265					GR24X 70	2
360, 450					M4 132	2
480 ARIETE					M6 198	2
480.DT					M4 132	2
ANTARES 100					L5 90P	1
ANTARES 110, 130		MC12 120 EHD				1
ANTARES 150		MC15 185 EHD / MC15 160 EHD				1
ARGON 50 (50 DT) (60) (60 DT) (70) (70 DT)					L5 90P	1
Argon Classic 55 (70)				G28 100 RST		1
ARGON F 55 (65) (75)				G28 100 RST		1
Argon F Classic 55 (70)				G28 100 RST		1
ASTER 60, 70				G28 100 RST		1
ATLANTA 45					M4 132	2
ATLANTA VIGNETO				AT 100 RSTd		1
AURORA 45				G28 100 RST		1
BUFALO 120, 130 DT		MC15 185 EHD / MC15 160 EHD				1
CENTAURO					M4 132	2
CENTURIUM 75 E, S, SDT				G28 100 RST		1
CONDOR 55				G28 100 RST		1
CORSARO 70					6AS8	1
DA 12					L5 90P	1
DA 25, 25 DT, 30, 30 DT				AT 100 RSTd		1
DELFINO 35				G28 100 RST		1
DELFINO 35 CKD					L3 70P	1
DORADO DT 55 (75) (85)					L5 100P	1
DORADO 65 DT				G28 100 RST		1
Dorado F 70 (75) (90) (100)					L5 100P	1

MARCHIO E MODELLO - MAKE AND MODEL MARQUE ET MODÈLE - MARKE UND MODELL MARCA Y MODELO - МАРКА И МОДЕЛЬ	powerCUBE		energyCUBE		Altre serie: Other series: TITANIUM CLASSICA MOTORENERGY	N° BTR
	APC	EHD	APC	RST		
SAME						
	cont.					
Dorado S 70 (75) (90) (100)					L5 100P	1
DRAGO		MC15 185 EHD / MC15 160 EHD				1
DRAGON					L5 90P	1
EXPLORER 65, 65 C, 75				G28 100 RST		1
EXPLORER 70, 80, 90 (C Erg.)				G28 100 RST		1
Explorer T 75 (85) (95)				G28 100 RST		1
Explorer TB 75 (85) (95)				G28 100 RST		1
Explorer-3 85 (100)					L5 100P	1
FOX 35, 45, 55				G28 100 RST		1
FRUTTETO 60, 70, 75, 85				G28 100 RST		1
FRUTTETO II 55 (70) (75) (90) (100)				G28 100 RST		1
FRUTTETO II 60 DT (85 DT)				G28 100 RST		1
GALAXI 170		MC15 185 EHD				1
GOLDEN 60 (65) (75) (85) DT					L5 100P	1
HERCULES 160 DT		MC15 185 EHD				1
IRON 175 S (190 S)		MC15 185 EHD / MC15 160 EHD				1
Iron 100 (110) (120)		MC15 185 EHD / MC15 160 EHD				1
Iron 130 (140) (160) (175) (185)	B 180 APC	B 180 EHD	B 185 APC			1
Iron Continuo 150.7 (165.7)	B 180 APC	B 180 EHD	B 185 APC			1
ITALIA 35, ITALIA DT					M4 132	2
JAGUAR 95 DT, EDT		MC12 120 EHD				1
KRIPTON 80, 90, 100		MC12 120 EHD				1
Krypton F 90 (100)				G28 100 RST		1
Krypton V 70 (80)				G28 100 RST		1
LASER 50, 110, 130		MC15 185 EHD / MC15 160 EHD				1
LASER 85, 90, 100		MC12 120 EHD				1
LASER 150		MC15 185 EHD				1
LEONE 70					M5 160	2
LEOPARD 85, D, EDT, TE		MC12 120 EHD				1
MINITAURO 60 C					6AS8	1
MINITAURUS 60		MC12 120 EHD				1
PANTHER 90, 95 DT		MC12 120 EHD				1
PULEDRO, DT, TRENTO					M4 132	2
RANGER 45					L3 70P	1
ROCK 55, 60 (C Gomma)				G28 100 RST		1
ROCK 70				G28 100 RST		1
ROW CROP 100.6		MC15 185 EHD / MC15 160 EHD				1
RUBIN 120, 135 DT		MC15 185 EHD / MC15 160 EHD				1

MARCHIO E MODELLO - MAKE AND MODEL MARQUE ET MODÈLE - MARKE UND MODELL MARCA Y MODELO - МАРКА И МОДЕЛЬ	powerCUBE		energyCUBE		Altre serie: Other series: TITANIUM CLASSICA MOTORENERGY	N° BTR
	APC	EHD	APC	RST		
SAME						
cont.						
RUBIN 150, 160, 180, 200 (DT) (Galileo)		MC15 185 EHD / MC15 160 EHD				1
SAMECAR DT					M4 132	2
SAMETTO, DT, DTV					M4 132	2
SATURNO 80, DT, S					6AS8	1
SILVER 80 (90) DT		MC12 120 EHD				1
SILVER 85 ,95		MC12 120 EHD				1
SILVER 100.4 DT		MC12 120 EHD				1
SILVER 100.6 DT		MC15 185 EHD / MC15 160 EHD				1
SILVER 105 (110)		MC15 185 EHD / MC15 160 EHD				1
SILVER 115, 130 (DT)		MC15 185 EHD / MC15 160 EHD				1
SIRENETTA				G28 100 RST		1
SOLAR 50, C55, 60, C60, C70				G28 100 RST		1
SOLAR C80, C90				G28 100 RST		1
SOLARIS 25 HYDRO					L3 70P	1
SOLARIS 35 (35 HD) (35 WIND)					L3 70P	1
SOLARIS 45, 45 II, WIND					L3 70P	1
Solaris 55					L3 70P	1
SUPERTITAN		MC15 185 EHD				1
TIGER		MC15 185 EHD / MC15 160 EHD				1
TITAN II 150, 165, 190		MC15 185 EHD				1
TRIDENT 130		MC12 120 EHD				1
VIGNERON 60, 75				G28 100 RST		1
STEYR						
190				AT 100 RSTd		1
540, 545, 548	A 135 APC	A 120 EHD / A 140 EHD				1
650, 658, 760, 768					GR24 70	2
870	B 180 APC	B 180 EHD / B 160 EHD	B 185 APC			1
875					L5 90P	1
980, 988	B 180 APC	B 180 EHD / B 160 EHD	B 185 APC			1
1030, 1090, 1100, 1108, 1200, 1300, 1400				AT 100 RSTd		1
8045, 8055					L5 90P	1
8060, 8065, 8070, 8075, 8080	A 135 APC	A 120 EHD / A 140 EHD				1

MARCHIO E MODELLO - MAKE AND MODEL MARQUE ET MODÈLE - MARKE UND MODELL MARCA Y MODELO - МАРКА И МОДЕЛЬ	powerCUBE		energyCUBE		Altre serie: Other series: TITANIUM CLASSICA MOTORENERGY	N° BTR
	APC	EHD	APC	RST		
STEYR						
cont.						
8085					L5 90P	1
8090	A 135 APC	A 120 EHD / A 140 EHD				1
8100, 8120, 8130	B 180 APC	B 180 EHD / B 160 EHD	B 185 APC			1
8110	A 135 APC	A 120 EHD / A 140 EHD				1
8140 DT, 8150					L5 90P	2
8160, 8160 DT, 8165, 8170, 8180					L5 90P	2
9115 Base	B 180 APC	B 180 EHD / B 160 EHD	B 185 APC			1
9125, 9145 Comfort	B 180 APC	B 180 EHD / B 160 EHD	B 185 APC			1
CVT 120, 130, 150	B 180 APC	B 180 EHD	B 185 APC			1
CVT 170		B 180 EHD (B03)				1
D 80, 84					L2 60P	1
D 180					L5 90P	2
D 188, 430, 540, 580				AT 100 RSTd		1
M 958 Comfort					L5 90P	1
M 968 Base					L5 90P	1
M 975 Comfort					L5 90P	1
M 9086, 9094 Base					L5 90P	1
VALPADANA						
4RM 18					E2X 45	1
4RM 20/32					L1X 44	1
4RM 180, 260					GR24X 70	1
4RM 300R , 320RS					L1X 44	1
4RM 350, 450, 545RS, 555RS				G28 100 RST		1
4RML					L5 90P	1
4RML 014					L1X 44	1
4RMR					L5 90P	1
440 RS, 1326					GR24X 70	1
1220 HST STD (1225 HST STD) (1330 HST STD)					L1 44P	1
1540, 1545, 1550, 1555					L2 60P	1
2555, 2565, 2575, 2580		MT 132 EHD				1
4040					L1X 44	1
4570, 4580, 4590, 4595				G28 100 RST		1
5570, 5580, 5590, 5595		MT 132 EHD				1
6055, 7070					GR24X 70	1
6550, 6560, 6575 (ISM) (ISR REV)					GR24X 70	1
CLIMBER 9565 Rev (9585 Rev)				G28 100 RST		1

MARCHIO E MODELLO - MAKE AND MODEL MARQUE ET MODÈLE - MARKE UND MODELL MARCA Y MODELO - МАРКА И МОДЕЛЬ	powerCUBE		energyCUBE		Altre serie: Other series: TITANIUM CLASSICA MOTORENERGY	N° BTR
	APC	EHD	APC	RST		
VALPADANA						
FRUTTETO 3560, 3570, 3580, 3590, 3595				G28 100 RST		1
MTA 2030					GR24X 70	1
MULTITRAC 9565 Rev (9585 Rev)				G28 100 RST		1
VCM 8, 12, 14					E2X 45	1
VIGNETO 3565, 3570, 3580					L2 60P	1
3100, 3300, 3400, 3500				G28 100 RST		1
VALTRA						
365, 465, 565, 665, 865				CHX 125 RST		1
600, 700, 800, 900				CHX 125 RST		1
6000, 6100, 6200, 6300, 6400, 6600, 6800, 6900 ('98->)	B 180 APC	B 180 EHD / B 160 EHD	B 185 APC			1
6250HI-6850HI, 8050HI-8950HI (->ott. '02)	B 180 APC	B 180 EHD / B 160 EHD	B 185 APC			1
8000, 8100, 8200, 8400, 8050, 8150, 8450, 8550, 8750 ('98->)	B 180 APC	B 180 EHD / B 160 EHD	B 185 APC			1
A65, A75, A85, A95				CHX 125 RST		1
C90, C150	B 180 APC	B 180 EHD / B 160 EHD	B 185 APC			1
M120, M130, M150	B 180 APC	B 180 EHD / B 160 EHD	B 185 APC			1
S230, S260 (->ott. '02)	B 180 APC	B 180 EHD / B 160 EHD	B 185 APC			1
S230, S260, S280 (nov. 2000 ->)	CX 225 APC	CX 200 EHD	CX 220 APC			1
T120, T130, T140, T160, T170, T180, T190	B 180 APC	B 180 EHD / B 160 EHD	B 185 APC			1
VENIERI						
2.63				G28 100 RST		1
4.23, 5.23, 6.23					L2X 60P	1
8.63				G28 100 RST		2
C 300, 302S, 332					GR24X 70	1
C 350, 382S, 423, 500, 553, 604				G28 100 RST		1
R 423, 500				G28 100 RST		1
VDC 35, 50				G28 100 RST		1
VDR 35, 37, 50				G28 100 RST		1

MARCHIO E MODELLO - MAKE AND MODEL MARQUE ET MODÈLE - MARKE UND MODELL MARCA Y MODELO - МАРКА И МОДЕЛЬ	powerCUBE		energyCUBE		Altre serie: Other series: TITANIUM CLASSICA MOTORENERGY	N° BTR
	APC	EHD	APC	RST		
VOLVO						
cont.						
646				G28 100 RST		1
861		D14 148 EHD				2
4200, 4300, 4400				G28 100 RST		2
4500, 4600				CH 125 RST		2
ZETOR						
25 A, K	A 135 APC	A 120 EHD / A 140 EHD				2
50 SUPER	B 180 APC	B 180 EHD	B 185 APC			1
2011, 2511, 3011, 3511, 3545, 4011					L5 100P	1
3320, 3340		D11 135 EHD				1
4320, 4340		D11 135 EHD				1
4341	A 135 APC					1
4511, 4712, 4718, 4911, 5011					L5 100P	1
5211	B 180 APC	B 180 EHD	B 185 APC			1
5213, 5243					L5 100P	1
5245, 5320, 5340	B 180 APC	B 180 EHD	B 185 APC			1
5341	A 135 APC					1
5511, 5545, 5711, 5718, 5745, 5748					L5 100P	1
5911, 6011, 6045, 6211, 6245	B 180 APC	B 180 EHD	B 185 APC			1
6341	A 135 APC					1
6441	B 180 APC	B 180 EHD / B 160 EHD	B 185 APC			1
6711, 6718	B 180 APC	B 180 EHD	B 185 APC			1
6745, 6748, 6911, 6945					L5 100P	1
7011, 7045, 7211, 7245	B 180 APC	B 180 EHD	B 185 APC			1
7341	A 135 APC					1
7441	B 180 APC	B 180 EHD / B 160 EHD	B 185 APC			1
7520, 7540		B 180 EHD (B03)				1
8011, 8045, 8111, 8145					L5 100P	1
8250	B 180 APC	B 180 EHD	B 185 APC			1
8441	B 180 APC	B 180 EHD / B 160 EHD	B 185 APC			1
8540	B 180 APC	B 180 EHD	B 185 APC			1
8621, 8641		B 180 EHD (B03)				1
9245					L5 100P	1
9520, 9540	B 180 APC	B 180 EHD	B 185 APC			1
9621, 9641		B 180 EHD (B03)				1
10011, 10045					L5 100P	1
10111, 10145, 10245					L5 100P	1
10520, 10540		B 180 EHD (B03)				1

CLAUSOLA DI NON RESPONSABILITÀ - DISCLAIMER - CLAUSE DE NON-RESPONSABILITÉ VERZICHTERKLÄRUNG - CLÁUSULA DE NON-RESPONSABILIDAD - ОТКАЗ

Le tipologie di prodotto consigliate per i veicoli, pur essendo il risultato di esperienze consolidate, costituiscono solo un nostro suggerimento tecnico. FIAMM non si assume alcuna responsabilità in merito ad eventuali applicazioni non corrette e/o aggiornate. In ogni caso per eventuali dubbi relativi ad applicazioni particolari o per ulteriori informazioni è possibile rivolgersi a: FIAMM S.p.A. inviando una e-mail all'indirizzo info.starter@fiamm.com.

Whilst every care is taken in preparing this catalogue; the indicated main applications represent only technical recommendations. FIAMM cannot accept any legal liability for inaccurate information. In case of any doubt related to particular applications or for more information you can contact: FIAMM S.p.A. sending an e-mail to info.starter@fiamm.com.

La plus grande attention a été apportée dans la préparation de ce catalogue. Cependant, il faut considérer que ces indications sont uniquement d'ordre technique. FIAMM n'accepte aucune responsabilité concernant des informations qui pourraient se révéler incorrectes. Un doute, une confirmation ou pour tous renseignements relatifs à des applications particulières Vous pouvez contacter: FIAMM S.p.A. en envoyant un e-mail à info.starter@fiamm.com.

Da trotz aller Sorgfalt bei der Erstellung des Kataloges die angeführten Hauptanwendungen nur technische Empfehlungen sein können, übernimmt FIAMM keine Haftung für fehlerhafte Informationen. Für Zweifel an bestimmte Anwendungen oder für weitere Informationen kontaktieren Sie: FIAMM s.p.a. eine E-mail an info.starter@fiamm.com senden.

Aunque este catálogo ha sido preparado con gran cuidado, las indicaciones sobre las principales aplicaciones sólo son recomendaciones técnicas. FIAMM no aceptará ninguna responsabilidad legal debida a alguna información inexacta. Para cualquier duda o consulta relativa a las aplicaciones particulares Usted puede comunicarse con: FIAMM S.p.A. enviando un e-mail a info.starter@fiamm.com.

На основе длительного опыта продукция рекомендована для легковых автомобилей и автомобилей тяжелой группы. Компания «Fiamm» не несет ответственность за неправильный подбор и использование типа аккумуляторной батареи, не соответствующий техническим характеристикам автомобиля. Дополнительную информацию и консультацию в случае сомнений по поводу специфических применений возможно получить в FIAMM S.p.A отправив запрос по адресу info.starter@fiamm.com.

Le prestazioni della nuova gamma truck - IN SINTESI

Performance of the new truck range - OVERVIEW

Les performances de la nouvelle gamme camions - EN RÉSUMÉ

Die Leistungswerte des neuen LKW-Sortiments - IN KÜRZE

Las prestaciones de la nueva gama Truck - EN RESUMEN

Характеристики новой гаммы изделий для грузовых автомобилей - КРАТКАЯ СВОДКА

	POTENZA DI AVVIAMENTO STARTING POWER PUISSANCE DE DÉMARRAGE STARTLEISTUNG POTENCIA DE ARRANQUE ПУСКОВАЯ МОЩНОСТЬ	ACCETTAZIONE DELLA CARICA CHARGE ACCEPTANCE ACCEPTATION DE LA CHARGE LADEAKZEPTANZ ACEPTACIÓN DE LA CARGA ДОЛЯ ЗАПАСАЕМОГО ЗАРЯДА (ЕМКОСТЬ)	RESISTENZA AL CICLAGGIO CYCLING RESISTANCE RÉSISTANCE AU CYCLAGE ZYKLENFESTIGKEIT RESISTENCIA ANTE LOS CICLOS СТОЙКОСТЬ К ЦИКЛИРОВАНИЮ	RESISTENZA ALLE VIBRAZIONI RESISTANCE TO VIBRATIONS RÉSISTANCE AUX VIBRATIONS RÜTTELFESTIGKEIT RESISTENCIA A LAS VIBRACIONES ВИБРОСТОЙКОСТЬ
POWERCUBE AGM	+++++	+++++	+++++	+++++
POWERCUBE APC	+++++	+++++	++++	+++++
POWERCUBE EHD	+++++	++++	+++	+++++
ENERGYCUBE APC	++++	+++++	+++++	+++++
ENERGYCUBE RST	+++++	++++	++	+++

● bassa low basse niedrig baja низкий уровень	●● media medium moyenne mittelmäßig media средний уровень	●●● buona good bonne gut buena хороший уровень	●●●● alta high élevée hoch alta высокий уровень	●●●●● ottima very good optimale hervorragend óptima очень высокий уровень	●●●●●● eccellente excellent excellente exzellent excelente исключительно высокий уровень
--	--	---	--	--	---

APPLICAZIONI - APPLICATIONS - APPLICATIONS - ANWENDUNGEN
APLICACIONES - ОБЛАСТИ ПРИМЕНЕНИЯ

Level Niveau Nivel Уровень	Product Name Nom du produit Produktname Nombre del producto Наименование	Tecnologia Technologie Technologie Technologie Технология	Overnight Pendant la nuit Nachts Overnight Ночное время	Long distance Longue distance Langstrecke Larga distancia Дальние расстояния	Express Delivery Livraison express Expresslieferung Entrega exprés Экспресс-доставка	Coach Car Überlandbus Autocar Междугородные автобусы	City Bus Bus urbain Stadtbus Autobús urbano Городские автобусы	Small tractor Petit tracteur Kleintraktor Tractor pequeño Тракторы малой мощности	Big Tractor Grand tracteur Großtraktor Tractor grande Тракторы большой мощности	Heavy Industrial Poids lourd industriel Schwere Industriefahrzeuge Industria de vehículos pesados Тяжелые промышленные условия эксплуатации	DIN size Taille DIN DIN-Größe Tamaño DIN Конструктивное исполнение согласно DIN
1	POWERCUBE AGM	AGM	✓			✓	✓		✓	✓	D7
2	POWERCUBE APC	APC	✓	✓		✓	✓		✓	✓	A-B-C
3	POWERCUBE EHD	EHD		✓	✓			✓			A-B-C & altri formats & autres formats und andere Formate & otros formatos и другие варианты
4	ENERGYCUBE APC	APC	✓		✓	✓	✓		✓	✓	B-C
5	ENERGYCUBE RST	RST			✓			✓			altri formats other formats autres formats andere Formate otros formatos другие варианты

- ✓ = massima resa
- ✓ = maximum performance
- ✓ = rendu maximum
- ✓ = maximaler Ertrag
- ✓ = máximo rendimiento
- ✓ = максимальная отдача

**FIAMM**
+ -



Group

**Your World,
Our Energy.**

FIAMM S.p.A.

V.le Europa, 75 - 36075 Montecchio Maggiore (VI) - Italia







Tel +39 0444 709311 - Fax +39 0444 699237

e-mail: info.starter@fiamm.comwww.fiamm.com - www.fiammnetwork.com [fiamm.batteries](https://www.facebook.com/fiamm.batteries) [fiambatteries](https://twitter.com/fiambatteries) [youtube.com/user/FIAMMvideo](https://www.youtube.com/user/FIAMMvideo)

Scopri tutte
le novità
FIAMM
attraverso
il QR code!

Find out all
about the
new FIAMM
products using
the QR code!

FIAMM: the best services tailored for you.

APP		iParts FIAMM	The FIAMM application allows you to find out the right battery for any car model, very quickly. All the types of batteries come with a picture and technical specifications for an easier identification.
		iOfficina FIAMM*	FIAMM Network Workshops can be reached and consulted thanks to an application that suggest the FIAMM closest Workshops and Car electricians, calculating the route to reach them.
WEB		fiamm.com	The company site of FIAMM Group
		fiammnetwork.com*	The portal serving workshops and motorists.
		Raccoltaamica.com*	The web site dedicated to the "Raccolta Amica" project, for a correct disposal of exhaust batteries.
		Motorenergy.it	The site dedicated to products for motorcycles, scooters, snowmobiles, ATV and Jet Sky.

*ONLY FOR ITALY

FIAMM Codice Code Code Codenummer Código Код	EAN Codice Code Code Codenummer Código Код	Short Code
---	---	-------------------

POWERCUBE - AGM - Absorbent Glass Mat		
--	--	--

7904567	8009601212968	D7 125 AGM
---------	---------------	-------------------

POWERCUBE - APC - Advanced Power Cycling		
---	--	--

7904568	8009601212975	A 135 APC
---------	---------------	------------------

7904569	8009601212982	B 180 APC
---------	---------------	------------------

7904570	8009601212999	CX 225 APC
---------	---------------	-------------------

POWERCUBE - EHD - Enhanced Heavy Duty		
--	--	--

7904571	8009601213002	D11 110 EHD
----------------	---------------	--------------------

7904572	8009601213019	A 120 EHD
----------------	---------------	------------------

7904573	8009601213026	MC12 120 EHD
----------------	---------------	---------------------

7904574	8009601213033	MT 132 EHD
----------------	---------------	-------------------

7904575	8009601213040	D11 135 EHD
----------------	---------------	--------------------

7904576	8009601213057	A 140 EHD
----------------	---------------	------------------

7904577	8009601213064	D14 148 EHD
----------------	---------------	--------------------

7904798	8009601213699	B 148 EHD
----------------	---------------	------------------

7904578	8009601213071	B 160 EHD
----------------	---------------	------------------

7904579	8009601213088	MC15 160 EHD
----------------	---------------	---------------------

7904580	8009601213095	B 180 EHD
----------------	---------------	------------------

7904581	8009601213101	B 180 EHD (B03)
----------------	---------------	------------------------

7904774	8009601213644	B 190 EHD
----------------	---------------	------------------

7904582	8009601213118	MC15 185 EHD
----------------	---------------	---------------------

7904583	8009601213125	CX 200 EHD
----------------	---------------	-------------------

7904584	8009601213132	C 200 EHD
----------------	---------------	------------------

ENERGYCUBE - APC - Advanced Power Cycling		
--	--	--

7904585	8009601213149	B 185 APC
----------------	---------------	------------------

7904586	8009601213156	CX 220 APC
----------------	---------------	-------------------

ENERGYCUBE - RST - Reliable Starter (DRY)		
--	--	--

7904587	8009601213163	A 120 RSTd
----------------	---------------	-------------------

7904588	8009601213170	B 160 RSTd
----------------	---------------	-------------------

7904589	8009601213187	B 180 RSTd
----------------	---------------	-------------------

7904590	8009601213194	CX 200 RSTd
----------------	---------------	--------------------

ENERGYCUBE - RST - Reliable Starter		
--	--	--

7904591	8009601213200	G28 100 RST
----------------	---------------	--------------------

7904592	8009601213217	G28X 100 RST
----------------	---------------	---------------------

7904593	8009601213224	CB 110 RST
----------------	---------------	-------------------

7904594	8009601213231	CBX 110 RST
----------------	---------------	--------------------

7904595	8009601213248	CB 110 RST (B01)
----------------	---------------	-------------------------

7904596	8009601213255	CH 125 RST
----------------	---------------	-------------------

7904597	8009601213262	CHX 125 RST
----------------	---------------	--------------------

7904598	8009601213279	MC 130 RST
----------------	---------------	-------------------

ENERGYCUBE - RST - Reliable Starter (DRY)		
--	--	--

7904599	8009601213286	AT 100 RSTd
----------------	---------------	--------------------

7904600	8009601213293	ATX 100 RSTd
----------------	---------------	---------------------